

Microwave Semiconductor Handbook

MICROWAVE ASSOCIATES,  INC.



HB-4008/August, 1979

SALES, SHIPPING AND SERVICE INFORMATION

HOW TO ORDER – UNITED STATES – MICROWAVE ASSOCIATES. Orders for Microwave Associates products may be placed with either our sales representatives or directly with Microwave Associates' sales department:
Microwave Associates, Inc.
Northwest Industrial Park
Burlington, Massachusetts 01803
Telephone: (617) 272-3000
TWX: 710-332-6789
TELEX: 94-9464

HOW TO ORDER – INTERNATIONAL. Customers outside the United States are served by Microwave Associates subsidiaries: Microwave Associates International, Inc., and Microwave Associates, Ltd., as well as by international sales representatives.

MICROWAVE ASSOCIATES INTERNATIONAL. All international orders (excluding the United Kingdom) may be placed with either our international sales representatives or directly with Microwave Associates International sales department:

Microwave Associates International, Inc. Telephone: (617) 272-3000
Northwest Industrial Park TWX: 710-332-6789. TELEX: 094-9464
Burlington, Massachusetts 01803 Cable: MICROWAVE BURLINGTON

UNITED KINGDOM. Orders in the United Kingdom may be placed directly with Microwave Associates, Ltd., sales department.

Microwave Associates, Ltd. Telephone: Dunstable 601441
Humphreys Road, Dunstable: Woodside Estate TELEX: 82295
Dunstable, Bedfordshire, England Cable: MICROWAVE LUTON

SHIPPING INSTRUCTIONS. Shipments will be made via parcel post or express, whichever is less expensive, unless other instructions are received. For rush service, we will ship by Air Freight, Air Express, or Air Parcel Post on request.

PRICES AND TERMS. The price and delivery of any item in this catalog is available from either our sales representatives or Microwave Associates sales department. Quotations are F.O.B. factory of origin, and are subject to change without notice. Terms are net 30 days if credit has been extended.

GOVERNMENT SOURCE INSPECTION. Government source inspection is available on any item upon receipt of the complete written confirmation of purchase order items, including the prime government contract number. Government source inspection with respect to some products increases unit price and extends delivery because of duplicate standard final inspection and testing. It is recommended wherever possible that a Certificate of Compliance be substituted for government source inspection to minimize price and delivery delay.

RETURNED MATERIAL. When returning material for repair or replacement, it is necessary first to contact the sales department. We require that complete information be included with the shipment giving a detailed description of the reason for its return, the date and purchase order on which it was obtained, the number of hours of operational use, and the exact address to which the material is to be re-shipped.

WARRANTY. We warrant to the original purchaser all products sold by us to be free of defects in material and workmanship. Our obligation under this warranty is limited to repair, exchange or credit. The warranty does not apply to any product which has been subject to accident, alteration or abuse. Detailed warranty provisions appear on each sales order.

APPLICATION ENGINEERING. Microwave Associates maintains a large support staff of technical sales engineers, both domestically and internationally, who are expert in specific areas of microwave technology. Each has an engineering background that combines formal engineering education with training in microwave specialties – often with many years of product design experience. As further technical support, Microwave Associates makes available the services of its engineering and scientific staff who may be consulted on more advanced circuit designs or application problems.

SPECIFICATIONS. We reserve the right to discontinue items and change specifications without notice.

FEDERAL SUPPLY CODE. Microwave Associates' Federal Supply Code for Manufacturers assigned number is 96341.

TABLE OF CONTENTS

	Bulletin	Page
RECEIVING DIODES		3
Mixer Diode Characteristics	—	5
SELECTION GUIDE - Silicon Point Contact Mixer Diodes in Hermetic Packages	—	6
Point Contact Diodes for Mixer Applications	4150	7
Point Contact Power Monitor Diodes	—	17
SELECTION GUIDE - Silicon Schottky Mixer Diodes in Hermetic Packages	—	18
SELECTION GUIDE - Silicon Schottky Mixer Diodes for Stripline and Hybrid Integrated Circuits	—	19
Schottky Barrier Diodes for Mixer Applications	4251	21
Low and Medium Barrier Schottky Mixer Diodes	4211	33
Silicon Beam Lead Schottky Diodes	4213	37
Detector Diode Characteristics	—	39
SELECTION GUIDE - Silicon Point Contact Detector Diodes in Hermetic Packages	—	40
Point Contact Diodes for Detector Applications	4151	41
SELECTION GUIDE - Silicon Schottky Detector Diodes in Hermetic Packages	—	48
SELECTION GUIDE - Silicon Schottky Detector Diodes for Stripline and Hybrid Integrated Circuits	—	49
Schottky Barrier Diodes for Detector Applications	4250	51
Detector Modules and Packaged Detectors	5152	65
Tunnel Diodes (Back Diodes) for Mixer and Detector Applications	5050	71
Schottky Barrier Diodes for Frequency Up-Conversion/Modulation	4252	79
Picosecond Switching Diodes for Digital or Logic Circuits	4309	85
CONTROL DIODES		87
SELECTION GUIDE - PIN Diodes	—	88
PIN Diodes for High Power Applications	4352	89
PIN Diodes for Fast Switching and Limiting Applications	4351	99
PIN Diodes for General Purpose Switching and Attenuation	4350	109
VHF-UHF PIN Diode TR Switch	5101	115
Hermetic Stripline Control Devices	4353	117
Broadband Power Control Modules	5150	127
Microwave Tuning Varactors	4650	135
Tunnel Diodes for Switching Applications	5051	145
POWER GENERATION AND AMPLIFICATION DEVICES		149
SELECTION GUIDE - Gunn Diodes	—	150
Low and Medium Power Gunn Diodes	4551	151
High Power Gunn Diodes	4550	161
High Frequency Gunn Diodes	4508A	169
Multiplier Varactors	4450	173
GaAs Parametric Amplifier Varactors	4850	191
npn Silicon Planar Transistors (MA-42020/K2000 Series)	5201	199
npn Silicon Planar Transistors (MA-42050/K5500 Series)	5202	203
npn Silicon Planar Transistors (MA-42000/K6000 Series)	5204	207
npn Silicon Planar Transistor (MA-42100)	5205	211
npn Silicon Planar Transistor (MA-42110)	5206	215
Gallium Arsenide Impatt Diodes	4700	219
Tunnel Diodes for Microwave Amplifier and Oscillator Applications	5052	223
Tunnel Diode Amplifier Application Notes	—	227
SPECIAL PRODUCTS		231
Silicon Epitaxial Wafers and Substrates	4002	233
Semiconductor Ceramic to Metal Packages	4001	237
Silicon MIS Capacitors	4052	245
GaAs Schottky Diodes for Millimeter Applications	—	248
INDEX		249
SALES, SHIPPING, AND SERVICE INFORMATION	(Inside Front Cover)	
SALES REPRESENTATIVES	(Inside Back Cover)	

RECEIVING DIODES

CONTROL DIODES

POWER GENERATION AND AMPLIFICATION

SPECIAL PRODUCTS

IN

RECEIVING DIODES

MIXER DIODES

Mixer Diode Characteristics 5

SELECTION GUIDE - Silicon Point Contact Mixer Diodes in Hermetic Packages 18

Point Contact Mixer Diodes 18

Point Contact Power Mixer Diodes 18

SELECTION GUIDE - Silicon Schottky Mixer Diodes in Hermetic Packages 18

SELECTION GUIDE - Silicon Schottky for Stripline and Hybrid Integrated Circuits 19

Schottky Barrier Mixer Diodes 21

Beam Lead Schottky Diodes 37

DETECTOR DIODES AND DETECTORS

Detector Diode Characteristics 40

SELECTION GUIDE - Silicon Point Contact Detector Diodes in Hermetic Packages 40

Point Contact Detector Diodes 41

SELECTION GUIDE - Silicon Schottky Detector Diodes in Hermetic Packages 48

SELECTION GUIDE - Silicon Schottky Detector Diodes for Stripline and Hybrid Integrated Circuits 49

Schottky Barrier Detector Diodes 51

Detector Modules and Packaged Detectors 65

Tunnel Diode Mixer and Detectors 71

UP CONVERTER/MODULATOR DIODES

PICOSECOND SWITCHING DIODES



Mixer Diode Characteristics

RECEIVER SENSITIVITY

A fundamental limitation on the sensitivity of a microwave receiver employing a resistive mixer arises from the fact that in the frequency conversion process only a fraction of the available RF signal power is converted into power at the intermediate frequency. This "overall" conversion loss is dependent on the diode junction, the diode's package parasitics, and on the matching at the input and output ports of the mixer. An additional limitation in performance arises from the fact that the mixer itself generates noise when it is driven by an RF signal (local oscillator). Thus, the conversion loss and the noise temperature ratio determine the overall noise figure of a microwave mixer diode. The mixer diode is completely characterized by the following parameters: overall receiver noise figure, conversion loss, noise temperature ratio, RF impedance and IF impedance.

NOISE FIGURE (NF_o)

The most important criterion of mixer diode performance is the noise figure. The noise at the output of a receiver is the sum of the noise arising from the input termination (source) and noise contributed by the receiver itself (i.e., due to IF amplifier and mixer diode). The noise factor is the ratio of the actual output noise power of the device, to the noise power which would be available if the device were perfect and merely amplified the thermal noise of the input termination without contributing any noise of its own. It is given by:

$$NF_o = \frac{S_i/N_i}{S_o/N_o}$$

S_i = available signal power at the input of receiver.

N_i = available noise power at the input of receiver.

S_o = available signal power at the output of receiver.

N_o = available noise power at the output of receiver.

The noise figure is the noise factor in decibels.

$$NF_o \text{ (dB)} = 10 \log_{10} \frac{S_i/N_i}{S_o/N_o}$$

The overall noise figure of a receiver depends on conversion loss (L_c), the noise temperature ratio (t) of the mixer diode and also on the noise figure of the IF amplifier (NF_{IF}). It is given by:

$$NF_o = L_c (t + NF_{IF} - 1).$$

The noise figure is usually measured with a gas tube by the Y factor method which compares the noise figure of the mixer with a standard noise source.

CONVERSION LOSS (L_c)

The conversion loss is the ratio of the available signal power output at the IF port divided by the available input power at the signal port (Mil-Standard 750, method 4101). It is determined by measuring the IF power with a power meter and a standard RF input (1 milliwatt of local oscillator power).

NOISE RATIO (t)

The noise ratio is the ratio of the output noise power as seen at the IF terminal to noise power of a resistor of the same impedance value as the IF impedance of the diode when driven by the local oscillator. Usually the local oscillator power is 1 mW.

The noise power of the diode consists of two contributions, white noise, which is frequency independent and flicker, or $1/f$ noise, which varies inversely with frequency below a frequency called the noise corner frequency. This corner frequency can vary from less than 10 kHz to more than 1 MHz depending on the type of diode used.

RF IMPEDANCE (Z_{RF})

The RF impedance (Z_{RF}) of the diode is of prime importance in the design of mixers. Impedance mismatch at the RF frequency not only results in signal loss due to reflection but also affects the IF impedance at the IF terminals of the mixer. The RF impedance of a varistor diode can be measured by the VSWR method.

IF IMPEDANCE (Z_{IF})

The IF impedance (Z_{IF}) is the impedance presented at the output terminals of the mixer when the rectifier is driven by a local oscillator. It is a function of the local oscillator power level and the RF properties of the mixer and circuit connected to the RF terminals of the mixer. It is generally measured with an admittance bridge. The IF impedance is important in determining the coupling circuits between the mixer and IF amplifier.

SELECTION GUIDE—SILICON POINT CONTACT MIXER DIODES IN HERMETIC PACKAGES

Test Frequency	1.0 GHz		3.0 GHz			9.375 GHz					18.0 GHz			22.9 GHz		34.8 GHz	
	Glass DO-7	Glass	Glass DO-7	Glass	Ceramic DO-23	Glass DO-7	Glass	Ceramic DO-23	Ceramic DO-23	Coaxial DO-37	Coaxial DO-37	Coaxial DO-37	Coaxial DO-37	Coaxial DO-37	Coaxial DO-37	Coaxial DO-36	Coaxial DO-36
MA Case Style	4	54	4	54	3	4	54	3	3	11	11	11	11	11	11	10	10
Max. Figure (dB)																	
5.5				MA-41504	1N21G												
6.0		MA-4815	1N831C	MA-41503	1N21F		MA-41508	1N23H									
6.5			1N831B	MA-41502		1N832C	MA-41508	1N23G	MA-41202G								
7.0			1N831A	MA-41501	1N21E	1N832B	MA-41507	1N23F	MA-41202F		1N78G	MA490C	MA-41201G				
7.5					1N21D	1N832A	MA-41506	1N23E	MA-41202E	MA-492E	1N78F	MA490F	MA-41201F				
8.0								1N23D	MA-41202D		1N78E	MA490E	MA-41201E				
8.5			1N831	MA-41500	1N21C					MA-492D							
9.0											1N78D	MA490D	MA-41201D			1N53D	
9.5							MA-41505				1N78C	MA490C	MA-41201C	1N26C	MA493C	1N53C	MA494C
10.0						1N832		1N23C	MA-41202C	MA-492C	1N78B	MA490B	MA-41201B			1N53B	MA494B
10.5						1N21B											
11.0											1N78	MA490		1N26B	MA493B	1N53A	MA494A
11.5	1N82A							1N23B	MA-41202B					1N26A	MA493A		
12.0																	
12.5																	
13.0														1N26	MA493	1N53	
Comments	JAN Types M/A OPL	Best band- width in glass	JAN Types M/A OPL	Best band- width	JAN Types M/A OPL	JAN Types M/A OPL	Best band- width in glass	JAN Types M/A OPL	Highest burnout RF tested Recommended types	Best band- width	JAN Types M/A OPL	M/A Types Broadband	Highest Burnout RF Tested. Recommended Types	JAN Types M/A OPL	M/A Types Broadband	JAN Types M/A OPL	M/A Types Broadband



MICROWAVE ASSOCIATES, INC. BURLINGTON, MASSACHUSETTS

All specifications are subject to change without notice.

Point Contact Diodes For Mixer Applications

Bulletin 4150

Cartridge Types

X-Band

S-Band

Coaxial Types

Ku-Band

K-Band

Ka-Band

X-Band

MQM Types

X-Band

Ku-Band

Glass Types

Sand X-Band

Additional Mixer Diodes

Mixer Diodes Cartridge Type

IN21-IN416 Series, S-Band
IN23-IN415 Series, X-Band
JAN IN21 and IN23 Series
MA-41202 Series, X-Band

CASE STYLES

DIM.	INCHES		MM	
	MIN.	MAX.	MIN.	MAX.
A	0.290	0.296	7.366	7.518
B	0.246	0.250	6.248	6.350
C	0.800	0.840	20.320	21.336
D	0.195	0.215	4.953	5.461
E	0.222	0.240	5.639	6.096
F	0.030	0.046	0.762	1.168
G	0.180	0.190	4.572	4.826
H	0.020	0.030	0.508	0.762
J	0.193	0.199	4.902	5.055
K	0.047	0.057	1.194	1.448

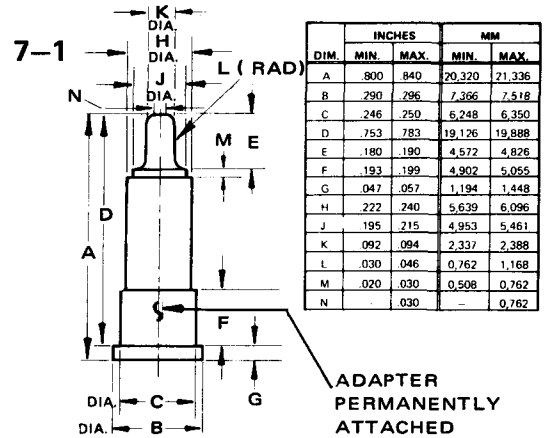
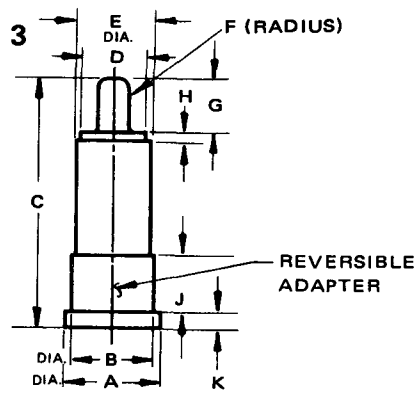

DIM.	INCHES		MM	
	MIN.	MAX.	MIN.	MAX.
A	.800	.840	20.320	21.336
B	.290	.286	7.366	7.518
C	.246	.250	6.248	6.350
D	.753	.783	19.126	19.888
E	.180	.190	4.572	4.826
F	.193	.199	4.902	5.055
G	.047	.057	1.194	1.448
H	.222	.240	5.639	6.096
J	.195	.215	4.953	5.461
K	.092	.094	2.337	2.388
L	.030	.046	0.762	1.168
M	.020	.030	0.508	0.762
N	.030	-	-	0.762

Not to scale.

MAXIMUM RATINGS (At 25°C, unless otherwise specified)

Incident CW RF Power	250 mW
Temperature Range	
Operating	-65 to +150°C
Storage	-65 to +150°C

ENVIRONMENTAL RATINGS PER MIL-STD-750

	Method	Levels
Temperature, Storage	1031	See Maximum Ratings
Temperature, Operating	-	See Maximum Ratings
Temperature Cycling	1051	5 Cycles, -65 to +150°C
Shock	2016	500 g's
Vibration	2056	15 g's
Constant Acceleration	2006	20,000 g's
Humidity	1021	10 Days

ELECTRICAL CHARACTERISTICS @ T_A = 25°C

Frequency Band	Test Frequency GHz	Model ^{1,2} Number	Model ^{1,3} Number	Max. Noise Figure ⁴ dB	IF Impedance ⁵ Ohms	1N23 - 1N415 SERIES		1N21 - 1N416 SERIES	
						Max. ⁶ VSWR	Burnout Ergs	Max. ⁶ VSWR	Burnout Ergs
S	3.060	1N21G	1N416G	5.5	350 - 450	1.3	5.0	1.3	5.0
			1N416F	6.0	350 - 450	1.3	5.0	1.3	5.0
			1N416E	7.0	350 - 450	1.3	5.0	1.3	5.0
			1N416D	7.3	325 - 475	1.5	2.0	1.5	2.0
X	9.375	1N23H	1N415H	6.0	335 - 465	1.3	2.0	1.3	2.0
			1N415G	6.5	335 - 465	1.3	2.0	1.3	2.0
			1N415F	7.0	335 - 465	1.3	2.0	1.3	2.0
			1N415E	7.5	335 - 465	1.3	2.0	1.3	2.0
			1N415D	8.2	325 - 475	1.3	2.0	1.3	2.0
1N23C	1N415C	9.5	325 - 475	1.5	2.0	1.5	2.0		

NOTES:

- All units are available in matched pairs either forward or reverse (one forward diode, one reversed diode) by adding the suffixes M or MR respectively. Matching criteria for pairs: $\Delta L_c = 0.3$ dB Max., $\Delta Z_{IF} = 25$ Ohms Max.
- Case Style 7-1; Adapter permanently attached.
- Case Style 3; Reversible Adapter
- Single sideband NF, $N_{IF} = 1.5$ dB, Max. Excess Gas Tube Noise Temperature = 15.2 ± 0.5 dB.
1N21 Series, $P_{LO} = 0.5$ mW, $R_L = 100 \Omega$, $f = 3.060$ GHz
1N23 Series, $P_{LO} = 1.0$ mW, $R_L = 100 \Omega$, $f = 9.375$ GHz
- AC METHOD IF = 60 to 1000 cps.
- $I_{RECT.} = 1.0$ mA.



MICROWAVE ASSOCIATES, INC. BURLINGTON, MASSACHUSETTS

JAN CARTRIDGE MIXER DIODES

ELECTRICAL CHARACTERISTICS @ $T_A = 25^\circ\text{C}$

Frequency Band	Test Frequency GHz	Model ^{1,8} Number	Max. Noise Figure dB	IF Impedance Ohms	Max. ⁶ VSWR	MIL-S-19500 Detail Number
S	3.060	1N21WG	5.5	350 450	1.3	321
		1N21WE	7.0	350 450	1.3	232A
		1N3655A	7.0	350 450	1.3	334
X	9.375	1N23WG	6.5	335 465	1.3	322A
		1N23WE	7.5	335 465	1.3	233B
		1N3745	9.5	325 475	1.5	—

HIGH RF BURNOUT CERAMIC MIXER DIODES

MAXIMUM RATINGS
(At 25°C , unless otherwise specified)

Incident RF Pulse Power	20W, 3ns (Balanced Mixer)
Incident CW RF Power	250 mW
Temperature Range	
Operating	-65 to $+150^\circ\text{C}$
Storage	-65 to $+150^\circ\text{C}$

ENVIRONMENTAL RATINGS PER MIL-STD-750

	Method	Levels
Temperature, Storage	1031	See Maximum Ratings
Temperature, Operating	—	See Maximum Ratings
Temperature Cycling	1051	5 Cycles, -65 to $+150^\circ\text{C}$
Shock	2016	500 g's
Vibration	2056	15 g's
Constant Acceleration	2006	20,000 g's
Moisture Resistance	1021	10 Days

ELECTRICAL CHARACTERISTICS @ $T_A = 25^\circ\text{C}$

Model ¹ Number	Max. ^{2,7} Noise Figure dB	Max. ^{3,7} VSWR	I.F. ⁴ Impedance Ohms	RF ⁵ Burnout Rating Watts	Direct Replacement for
MA-41202E	7.5	1.3	335-465	20	1N23E
MA-41202F	7.0	1.3	335-465	20	1N23F

NOTES:

- All units are available in matched pairs either forward or reverse (one forward diode, one reversed diode) by adding the suffixes M or MR respectively. Matching criteria for pairs: $\Delta L_c = 0.3$ dB Max.; $\Delta Z_{IF} = 25$ Ohms Max.
- Single sideband NF, $N_{IF} = 1.5$ dB Max. Excess Gas Tube Noise Temperature = 15.2 ± 0.5 dB.
- $I_{RECT.} = 1.0$ mA; $R_L = 100 \Omega$
- AC METHOD: IF = 60 to 1000 cps.

- This is a single shot 15,000 pulse (3 ns pulse width) burnout test.
- $R_L = 100 \Omega$ for VSWR measurement
- Unless otherwise specified, test conditions are:

$f_o = 9.375$	$Z_M = 400$ Ohms
$P_o = 1.0$ mW	Mount, Jan 105
$R_L = 100$ Ohms	
- JAN cartridge mixer diodes are in Case Style 3.

Mixer Diodes Coaxial Type

X-Band – MA-492 Series
Ku-Band – 1N78 and MA-490 Series
K-Band – 1N26 and MA-493 Series
Ka-Band – 1N53 and MA-494 Series

CASE STYLES

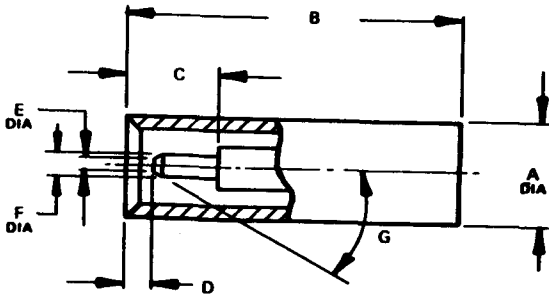

10

11

DIM.	INCHES		MM	
	MIN.	MAX.	MIN.	MAX.
A	0.158	0.162	4.01	4.11
B	0.845	0.855	13.84	14.10
C	0.089	—	2.51	—
D	0.010	0.018	0.25	0.46
E	0.019	0.021	0.48	0.53
F	0.044	0.046	1.12	1.17
G	42°	48°	—	—

DIM.	INCHES		MM	
	MIN.	MAX.	MIN.	MAX.
A	0.215	0.220	5.45	5.58
B	0.734	0.766	18.64	19.45
C	0.147	—	0.37	—
D	0.011	0.028	0.28	0.71
E	0.007	0.017	0.18	0.43
F	0.031	0.033	0.79	0.84
G	42°	48°	—	—

MAXIMUM RATINGS (At 25°C, unless otherwise specified)

Incident CW RF Power	100 mW
Temperature Range	
Operating	-65 to +150°C
Storage	-65 to +150°C

ENVIRONMENTAL RATINGS PER MIL-STD-750

	Method	Levels
Temperature, Storage	1031	See Maximum Ratings
Temperature, Operating	—	See Maximum Ratings
Temperature Cycling	1051	5 Cycles, -65 to +150°C
Shock	2016	500 g's
Vibration	2056	15 g's
Constant Acceleration	2006	20,000 g's
Moisture Resistance	1021	10 Days

ELECTRICAL CHARACTERISTICS @ T_A = 25°C

Frequency Band	Test Frequency GHz	Model ¹ Number	Model ¹ Number	Case Style	Max. Noise Figure ^{2, 3} dB	IF Impedance ³ Ohms		Max. ³ VSWR	Burnout Rating Ergs
						Min.	Max.		
X	9.375	—	MA-492F	11	7.0	250	450	1.3	2.0
			MA-492E	11	7.5	250	450	1.3	2.0
			MA-492D	11	8.5	250	450	1.7	2.0
			MA-492C	11	9.5	250	450	1.7	2.0
KU	16.000	1N78G	MA-490G	11	7.0	400	565	1.5	1.0
			MA-490F	11	7.5	400	565	1.5	1.0
			MA-490E	11	8.0	400	565	1.5	1.0
			MA-490D	11	8.8	400	565	1.5	1.0
			MA-490C	11	9.5	400	565	1.5	1.0
			MA-490B	11	10.0	365	565	1.6	1.0
K	23.984	1N26C	MA-493C	11	9.5	400	600	1.5	0.3
			MA-493B	11	11.0	400	600	1.5	0.3
K _a	34.860	1N53D	MA-494D	10	9.0	400	800	1.6	0.3
			MA-494C	10	9.0	400	800	1.6	0.3
			MA-494B	10	10.0	400	800	1.6	0.3
			MA-494A	10	11.1	400	800	1.6	0.3
			MA-494	10	13.1	400	800	1.6	0.3

NOTES:

- MA-490, 492, 493, 494 are broadband diodes tested in broadband test mounts. All units are available in matched pairs either forward or reverse (one forward diode, one reversed diode) by adding the suffixes M or MR respectively. Matching criteria for pairs: $\Delta L_C = 0.3$ dB Max.; $\Delta Z_{IF} = 25$ Ohms Max.
- Single sideband NF, $N_{IF} = 1.5$ dB Max. Excess Gas Tube Noise Temperature = 15.2 ± 0.5 dB.
- Unless otherwise specified, test conditions are: f_o = as indicated, $P_o = 1.0$ mW, $Z_M = 400$ Ohms, $R_L = 100$ Ohms.

JAN COAXIAL MIXER DIODES

ELECTRICAL CHARACTERISTICS @ $T_A = 25^\circ\text{C}$

Frequency Band	Test Frequency GHz	Model Number	Case Style	Max. Noise Figure dB	IF Impedance Ohms	Max. VSWR	MIL-S-19500 Detail Number
Ku	16.000	1N78C	11	9.5	400 - 565	1.5	130A
K	23.984	1N26B	11	11.0	400 - 600	1.5	128A
Ka	34.860	1N53	10	13.1	400 - 800	1.6	238
Ka	34.860	1N53B ⁵	10	10.0	400 - 800	1.6	—

HIGH RF BURNOUT KU-BAND MIXER DIODES

MAXIMUM RATINGS
(At 25°C , unless otherwise specified)

Incident RF Power Peak	10W, 3 ns (Balanced Mixer)
Incident CW RF Power	250 mW
Temperature Range	
Operating	-65 to $+150^\circ\text{C}$
Storage	-65 to $+150^\circ\text{C}$

ENVIRONMENTAL RATINGS PER MIL-STD-750

	Method	Levels
Temperature, Storage	1031	See Maximum Ratings
Temperature, Operating	—	See Maximum Ratings
Temperature Cycling	1051	5 Cycles, -65 to $+150^\circ\text{C}$
Shock	2016	500 g's
Vibration	2056	15 g's
Constant Acceleration	2006	20,000 g's
Moisture Resistance	1021	10 Days

ELECTRICAL CHARACTERISTICS @ $T_A = 25^\circ\text{C}$

Model Number	Case Style	Max. ¹ Noise Figure dB	Typ. Conversion Loss dB	Max. ^{2, 3} VSWR		I.F. ³ Impedance Ohms	Typ. ³ Rectified Current mA	RF ⁴ Burnout Rating Watts
				2a	2b			
MA-41201D	11	8.8	6.5	1.5	2.5	400 - 565	1.4	10
MA-41201E	11	8.0	6.0	1.5	2.5	400 - 565	1.4	10
MA-41201F	11	7.5	6.0	1.5	2.5	400 - 565	1.4	10
MA-41201G	11	7.0	5.5	1.5	2.5	400 - 565	1.4	10

NOTES:

- Single Sideband NF @ 16 GHz; IF = 30 MHz
L.O. Power 1.0 mW; $N_{IF} = 1.5$ dB; JAN 201 Mount;
 $R_L = 100$ Ohms
Relative excess Gas Tube Noise Temperature = 16.0 ± 0.5 dB.
- (a) VSWR at 16 GHz in JAN 201 Mount, $R_L = 100$ ohms.
(b) VSWR 12.5 to 17.5 GHz swept; MA-595 C mount,
 $R_L = 22$ ohms.
(Maximum VSWR of MA-595C with 65 + J0 Load 1.2:1,
12.5 to 17.5 GHz).
- RF Power = 1.0 mW, $R_L = 100$ Ohms, JAN 201 Mount,
 $f_o = 16$ GHz.
- This is a single shot 15,000 pulse (10W peak, 3 nS pulse width) burnout test.
- Pending JAN approval
- All units are available in reverse polarity, matched forward pairs, or matched opposite polarity (one forward diode, one reverse diode) pairs by adding the suffixes R, M, or MR respectively. Matching criteria for pairs — $\Delta L_C = 0.3$ dB Max.,
 $\Delta Z_{IF} = 25$ Ohms Max.

Mixer Diodes MQM

X and Ku-Band – MA-41220 Series

CASE STYLE 100

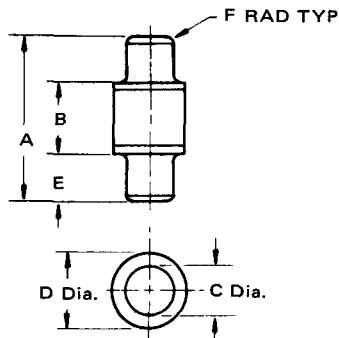

DIM	INCHES		MM	
	MIN	MAX	MIN	MAX
A	.197	.207	5.00	5.26
B	.070	.082	1.78	2.08
C	.060	.064	1.52	1.63
D		.084		2.13
E		.062 REF		1.57 REF
F		.012		.30

MAXIMUM RATINGS (At 25°C unless otherwise specified)

Incident RF CW Power	100 mW
Incident RF Peak Pulse Power (3 ns pulse width, 1000 pps)	2.0 Watts
Temperature Range	
Operating	-65 to +150°C
Storage	-65 to +150°C

ENVIRONMENTAL RATINGS PER MIL-STD-750

	Method	Levels
Temperature Storage	1031	-65 to +150°C
Temperature Cycle	1051	5 Cycles -65 to +150°C
Shock	2016	500 g's
Vibration	2056	15 g's
Constant Acceleration	2006	20,000 g's
Humidity	1021	10 Days

ELECTRICAL CHARACTERISTICS @ T_A = 25°C

Model Number	Frequency Bands	Case Style	Test Frequency GHz	Max. ¹ Noise Figure dB	Max. VSWR	IF Impedance Ohms
MA-41220- C	X	100	9.375	9.0	2.0	250 - 500
MA-41220- E		100	9.375	7.5	1.8	250 - 500
MA-41220- F		100	9.375	7.0	1.6	250 - 500
MA-41220- G		100	9.375	6.5	1.5	250 - 500
MA-41221- D	X, Ku	100	16.0	9.0	—	—
MA-41221- E		100	16.0	8.0	—	—
MA-41221- F		100	16.0	7.5	—	—

NOTES:

- Test Conditions: Noise figure is single sideband measured with 30 MHz IF, $NF_{IF} = 1.5$ dB, Max. and local oscillator power = 1.0 mW; excess gas tube noise at 9.375 GHz = 15.3 ± 0.5 dB.
at 16.0 GHz = 16.0 ± 0.5 dB
- All units available as matched pairs by adding the suffix "M". Matching criteria for packaged pairs: $\Delta NF_0 = 0.3$ dBm Max. $\Delta Z_{IF} = 25$ ohms, Max.



MICROWAVE ASSOCIATES, INC. BURLINGTON, MASSACHUSETTS

Mixer Diodes Glass Packages

UHF, S and X-Band
1N831 and 1N832 Series
1N82 Series
MA-41500 Series (PicoMin)

CASE STYLES

4

54

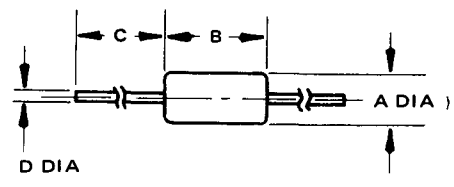

TYPICAL
 $L_p = 2.5 \text{ nH}$
 $C_p = 0.07 \text{ pF}$

DIM.	INCHES		MM	
	MIN.	MAX.	MIN.	MAX.
A	0.230	0.300	5.84	7.62
B	0.085	0.107	2.16	2.72
C		1.000		25.4
D	0.018	0.022	0.46	0.56

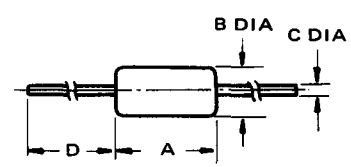

TYPICAL
 $L_p = 1.0 \text{ nH}$
 $C_p = 0.05 \text{ pF}$

DIM.	INCHES		MM	
	MIN.	MAX.	MIN.	MAX.
A	.145	.165	3.68	4.19
B	.068	.075	1.72	1.91
C	.014	.016	0.35	0.41
D	1.000	1.500	25.4	38.1

Not to scale.

MAXIMUM RATINGS (At 25°C unless otherwise specified)

Incident Peak Pulse RF Power	5.0 W
3 ns Pulse Width, 1000 pps	
Incident (CW) RF Power	
1N831	375 mW
1N832	325 mW
MA41500	250 mW
Temperature Range	
Operating	-65 to +150°C
Storage	-65 to +150°C

ENVIRONMENTAL RATINGS PER MIL-STD-750

	Method	Levels
Temperature, Storage	1031	See Maximum Ratings
Temperature, Operating	—	See Maximum Ratings
Temperature Cycling	1051	5 Cycles, -65 to +150°C
Shock	2016	500 g's
Vibration	2056	15 g's
Constant Acceleration	2006	20,000 g's
Humidity	1021	10 Days

ELECTRICAL CHARACTERISTICS

Model ^{1,2} Number	Test Frequency GHz	Max. ^{3,4,5}	Typical ^{4,5}	IF ^{4,5} Impedance Ohms	Case Style
		Noise Figure dB	Conversion Loss dB		
1N831	3.06	8.3	5.5	350-450	4
JAN 1N831A ^B	3.06	7.0	5.0	350-550	4
1N831B	3.06	6.5	4.5	350-550	4
1N831C	3.06	6.0	4.0	350-450	4
1N832	9.375	9.5	7.0	325-475	4
1N832A	9.375	7.5	6.0	335-465	4
JAN 1N832B ^B	9.375	7.0	5.0	335-465	4
1N832C	9.375	6.5	4.5	335-465	4

Continued on following page.

ELECTRICAL CHARACTERISTICS (Continued)

Model ^{1,2} Number	Test Frequency GHz	Max. ^{3,4,5}	Typical ^{4,5}	Ratings ^{4,5}	Case Style
		Noise Figure dB	Conversion Loss dB	IF Impedance Ohms	
MA-41500	3.06	8.3	6.5	200-500	54
MA-41501	3.06	7.0	5.0	250-450	54
MA-41502	3.06	6.5	4.5	250-450	54
MA-41503	3.06	6.0	4.0	250-450	54
MA-41504	3.06	5.5	4.0	250-450	54
MA-41505	9.375	9.5	7.0	200-400	54
MA-41506	9.375	7.5	6.0	200-400	54
MA-41507	9.375	7.0	5.0	200-400	54
MA-41508	9.375	6.5	4.5	200-400	54
MA-41509	9.375	6.0	4.0	200-400	54

UHF MIXER DIODES

Model Number	Case Style	Typ.	Min.	Max. ⁷
		Forward Voltage @ 15mA Volts	Reverse Voltage @ 500μA Volts	Noise Figure dB
1N82A	4	0.75	3.0	14.0
JAN 1N82AG ⁶	4	0.50	3.0	14.5

NOTES:

- Diodes available as single or matched pairs by adding M to model number.
- Matching criteria for pairs.
 $\Delta L_c = 0.3$ dB Max.
 $\Delta Z_{IF} = 25 \Omega$ Max.
- Noise figure is single side band, $N_{IF} = 1.5 \pm 0.2$ dB. Relative excess gas tube noise temperature = 15.2 dB ± 0.5 dB @ 3.06 GHz, 15.3 ± 0.5 at 9.375 GHz.
- All S-Band measurements for the 1N831 Series at 0.5 mW L.O. in fixed tuned JAN holder with adapter at 3.06 GHz, $R_L = 100 \Omega$. For the MA-41500 to MA-41504 Series, test holder JD1908 is used.
- All X-Band measurements for the 1N832 Series at 1.0 mW L.O. in fixed tuned JAN holder with adapter at 9.375 GHz, $R_L = 100 \Omega$. For the MA-41505 to MA-41509 Series, test holder JD2078 is used.
- The JAN 1N82AG is intended for use as a mixer in the UHF frequency range. It is manufactured to conform to MIL-STD-19500/250B and tested to MIL-STD-750 prescribed methods.
- L.O. Drive = 1.3 mA; $R_L = 10$ Ohms; $N_{IF} = 4.5$ dB; $F_O = 890$ MHz.
- Pending approval to military specifications.

MA-41500 SERIES MIXER DIODES TYPICAL PERFORMANCE CURVES

FIGURE 1 NOISE FIGURE VS L.O. POWER

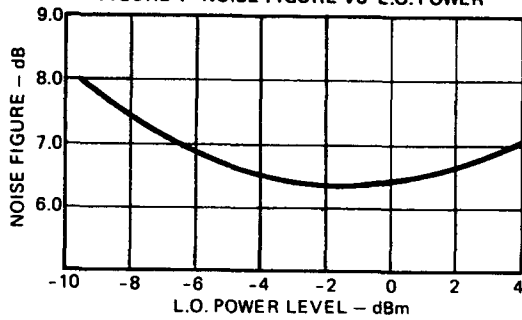

FIGURE 2 NOISE FIGURE VS TEMPERATURE

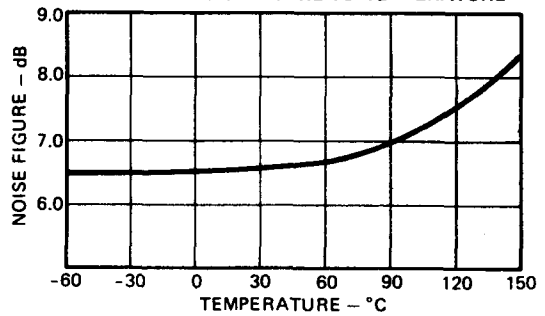

FIGURE 3 VSWR VS L.O. POWER

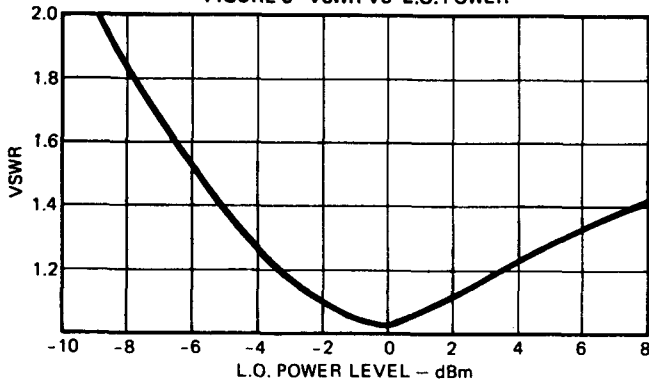

FIGURE 4 VSWR VS TEMPERATURE

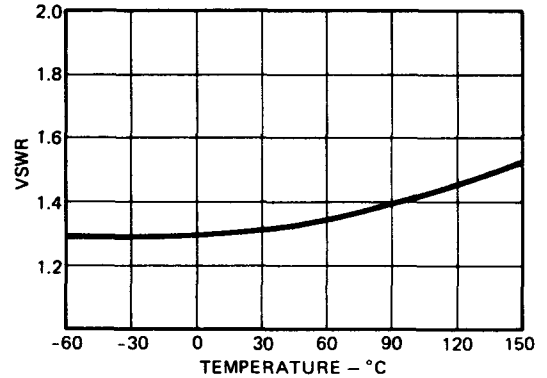

FIGURE 5 Z_{IF} VS. L.O. POWER

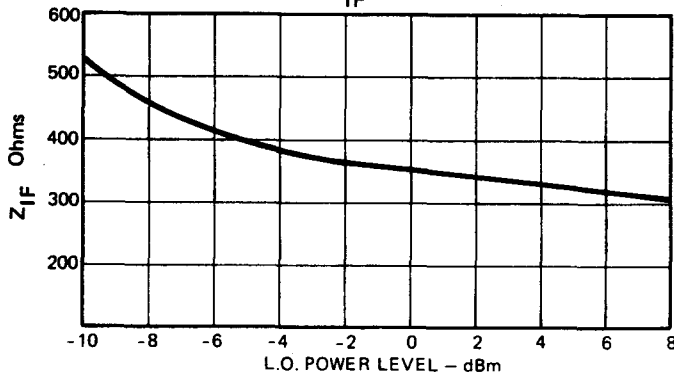

FIGURE 6 Z_{IF} VS. TEMPERATURE

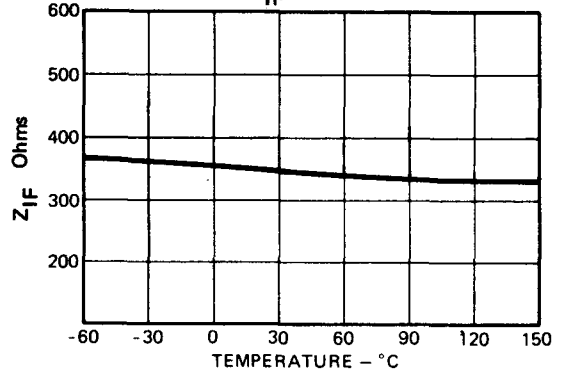
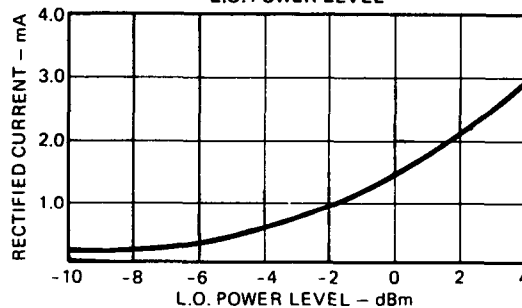

FIGURE 7 DC RECTIFIED CURRENT VS L.O. POWER LEVEL



Additional JEDEC Point Contact Mixer Diodes

S through Ku-Band

ELECTRICAL CHARACTERISTICS @ $T_A = 25^\circ\text{C}$

Model Number	Case Style	Test Freq. GHz	Max. Noise Figure dB	IF Impedance Ohms		Max. VSWR	Burnout Rating
				Min.	Max.		
1N3655	3	3.06	8.3	300	500	—	10.0 ²
1N3655B	3	3.06	6.0	350	450	1.3	10.0 ²
1N3745	3	9.375	9.5	325	475	1.5	5.0 ²
1N149	7-1	9.375	8.3	325	475	—	—
JAN 1N263 ^{4,5}	151 ⁶	9.375	7.5	140	210	1.3	1.0 ³
1N4600	11	13.3	9.5	400	565	1.5	1.0 ³
1N4601	11	13.0	8.8	400	565	1.5	1.0 ³
1N4602	11	13.3	8.0	400	565	1.5	1.0 ³
JAN 1N1838 ^{1,5}	151 ⁶	13.3	32	450	750	3.0	—
1N4603	11	16.0	9.5	400	565	1.5	1.0 ³
1N4604	11	16.0	8.8	400	565	1.5	1.0 ³
1N4605	11	16.0	8.0	400	565	1.5	1.0 ³

NOTES:

1. Germanium point contact diode for doppler applications. Noise figure is measured at IF = 20 KHz.
2. Burnout rating in watts using a 3 nS pulse.
3. Burnout rating in ergs.
4. Germanium Point Contact Diode.
5. These units are available in matched pairs either forward or reverse (one forward diode, one reverse diode) by adding the suffixes M or MR respectively.
6. Complete case style description available on request.



MICROWAVE ASSOCIATES, INC. BURLINGTON, MASSACHUSETTS

All specifications are subject to change without notice.

Point Contact Power Monitor Diodes

UHF through Ku-Band

ELECTRICAL CHARACTERISTICS @ T_A = 25°C

Model Number	Case Style	Test Freq. MHz	Load Resist. Ohms	Input Power Level mW	Power Level dBm	Rectified Current μ A		Output Volt. mV	
						Min.	Max.	Min.	Max.
UHF BAND									
MA-437 1N2771	7-1	140	1515	—	-2.8	92	109	—	—
		375	1515	—	-2.8	102	119	—	—
		750	1515	—	-2.8	104	123	—	—
X-BAND									
1N3143	7-1	9,375	10000	.05	—	—	—	72	112
1N3778	3	9,375	10000	10.0	—	—	—	2400	3000
Ku-BAND									
MA-4135	11	16,000	10000	.05	—	—	—	20	50
		16,000	10000	1.0	—	—	—	600	850
		16,000	10000	10.0	—	—	—	2400	3000

SELECTION GUIDE-SILICON SCHOTTKY MIXER DIODES IN HERMETIC PACKAGES

Test Frequency Case Style Max. Noise Figure dB	1 GHz	3 GHz				9.3 GHz										16 GHz					
	Medium Barrier	Medium Barrier				Low Barrier				Medium Barrier						Low Barrier		Medium Barrier			
	Glass	Ceramic	C-Spring Glass	MCM	Whisker Glass	Ceramic MCM	Pill			Ceramic	C-Spring Glass	MCM	Ceramic MCM	Pill	Ceramic MCM	Pill	Coaxial	MCM	Ceramic MCM	Pill	
	54	3	54	100	54	119	120	196		3	54	100	119	120	119	120	11	100	119	120	
5.0		MA-40051H																			
5.5	MA-4862	MA-40051G	MA-4853	MA-40003					MA-40071I												
6.0		MA-40051F		MA-40002		MA-40100	MA-40105	MA-40126	MA-40071H		MA-40006	MA-40150	MA-40155								
6.5	MA-4863		MA-4852	MA-40001	MA-40103	MA-40101	MA-40106	MA-40127	MA-40071G	MA-40103	MA-40153	MA-40008	MA-40151	MA-40156	MA-40110	MA-40115	MA-4861H 1N5438	MA-40015	MA-40160	MA-40162	
7.0		MA-40051E			MA-40104	MA-40102	MA-40107	MA-40128	MA-40071F	MA-40104	MA-40158	MA-40007	MA-40152	MA-40157	MA-40111	MA-40116	MA-4861G 1N5437	MA-40014	MA-40161	MA-40163	
7.5			MA-4851						MA-40071E	MA-4856							MA-4861F 1N5436	MA-40013			
8.0												MA-40006					MA-4861E	MA-40012			
8.5										MA-4855											
9.0																				MA-4861D	
Comment	General purpose low cost diodes	Best 1/2 noise	Best dynamic range	Broad-band	Best low local oscillator power. Best burnout	Bonded diode. Best burnout	Bonded pill	Broad-band	Best 1/2 noise	Best dynamic range	Best Bandwidth	Bonded diodes	Bonded diode. Best burnout	Bonded pill	For waveguide low mixers	Best bandwidth Useful to 40 GHz					



MICROWAVE ASSOCIATES, INC. BURLINGTON, MASSACHUSETTS

All specifications are subject to change without notice.

SELECTION GUIDE-SILICON SCHOTTKY MIXER DIODES FOR STRIPLINE AND HYBRID INTEGRATED CIRCUITS

Case Style Frequency	134 Chip	137 Stripline	81 Lid	121 Microstrip	135 Chip	185 Beamlead	Note
L-Band	MA-40190						
S-Band	MA-40191						
C-Band		MA-40033 MA-40034 MA-40035					Medium Barrier
X-Band			MA-40121 MA-40171	MA-40122 MA-40172	MA-40140 MA-40170	MA-40123 MA-40173	Low Barrier Medium Barrier
Ku-Band					MA-40119 MA-40169	MA-40124 MA-40174	Low Barrier Medium Barrier



MICROWAVE ASSOCIATES, INC. BURLINGTON, MASSACHUSETTS

All specifications are subject to change without notice.

Schottky Barrier Diodes For Mixer Applications

Bulletin 4251

Medium Barrier

Ku Band Coaxial Series

L-X Band Glass Series

S-Ku Band MQM Series

Stripline Series

1N21, 1N23 Equivalents



Medium Barrier Schottky Mixer Diodes

Ku-Band Coaxial Series MA-4861

CASE STYLE

11

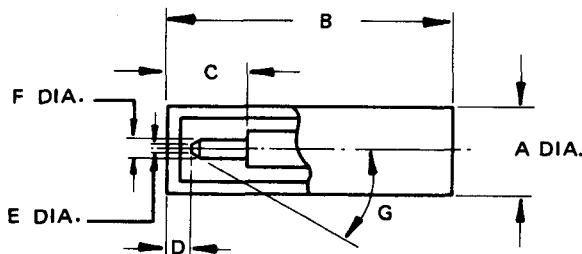

DIM.	INCHES		MM	
	MIN.	MAX.	MIN.	MAX.
A	.215	.220	5.46	5.59
B	.735	.765	18.67	19.43
C	.147		3.74	
D	.011	.028	0.28	0.71
E	.007	.017	0.177	0.432
F	.031	.033	0.787	0.838
G	.42"	.48"		

MAXIMUM RATINGS

(@ 25°C, Unless Otherwise Specified)

Incident RF CW Power	100 mW
Incident RF Peak Pulse Power (3 ns Max. pulse width, 1000 pps)	2.0 W
DC Current	50 mA
Reverse Voltage ($I_R = 10 \mu A$)	2 V
Temperature Range:	
Operating	-65 to +150°C
Storage	-65 to +150°C

ENVIRONMENTAL RATINGS PER MIL-STD-750

	Method	Levels
Temperature, Storage	1031	See Max. Ratings
Temperature, Operating	—	See Max. Ratings
Temperature Cycling	1051	5 Cycles, -65 to +150°C
Shock	2016	500 g's
Vibration	2056	20 g's
Constant Acceleration	2006	20,000 g's
Humidity	1021	10 Days

ELECTRICAL CHARACTERISTICS @ $T_A = 25^\circ C$

Model Number	Max. ¹ Noise Figure dB	Max. ^{1,2} VSWR	IF ³ Impedance Ohms
MA4861E	8.0	2.5	250 - 500
MA4861F	7.5	2.0	300 - 550
MA4861G	7.0	2.0	300 - 550
MA4861H	6.5	2.0	300 - 550

All units are also available as individual reverse, matched pair forward, and matched pair forward and reverse by adding the suffix "R", "M" and "MR" respectively to the model number.

Matching criteria for pairs: $\Delta L_C = 0.3$ dB, Max.; $\Delta Z_{IF} = 25$ Ohms, Max.

NOTES:

- Single sideband NF measured at 16 GHz with 30 MHz IF. Local oscillator power = 0.5 mW Nom., $N_{IF} = 1.5$ dB Max., JAN-201 mount. $R_L = 100$ Ohms.
- Swept measurement 12.5 to 17.5 GHz in MA595C broadband mount with $R_L = 22$ Ohms. (VSWR is 1.5 Max. at 16 GHz, $R_L = 100$ Ohms in JAN-201 mount). Max. VSWR of MA595C with $65 + j0$ load = 1.2 from 12.5 to 17.5 GHz (swept measurement).
- RF Power = 0.5 mW Nom., $R_L = 22$ Ohms for MA595C mount and $R_L = 100$ Ohms for JAN-201 mount.
- Coaxial case diode polarity is such that the sleeve is positive with respect to center conductor when current flows in the forward direction.



MICROWAVE ASSOCIATES, INC. BURLINGTON, MASSACHUSETTS

TYPICAL PERFORMANCE CURVES - MA-4861 SERIES

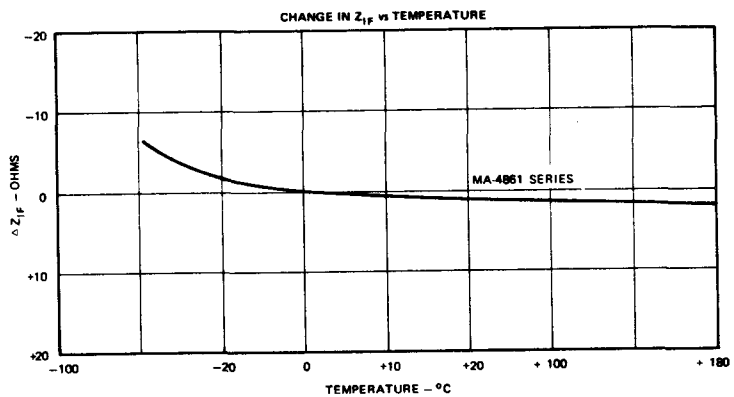
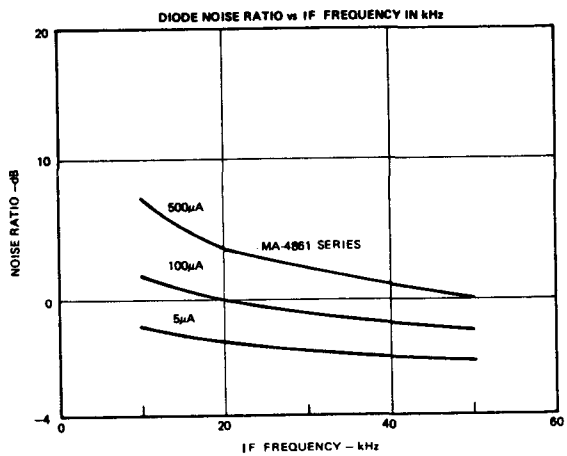
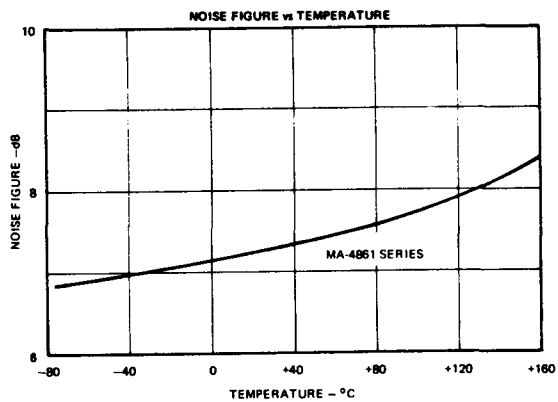
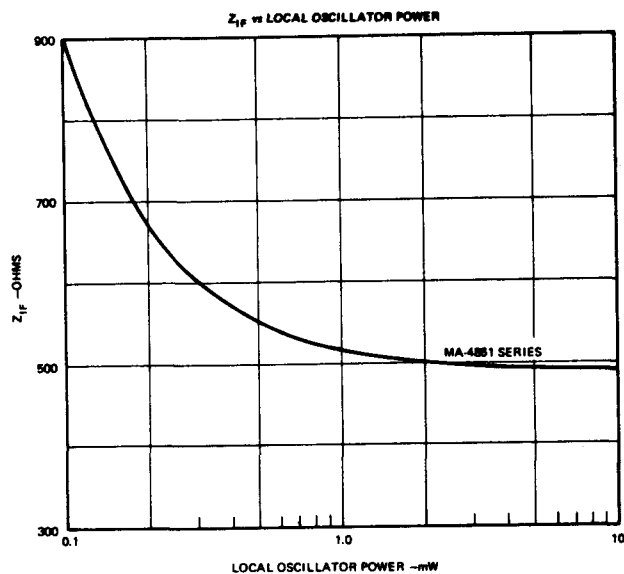
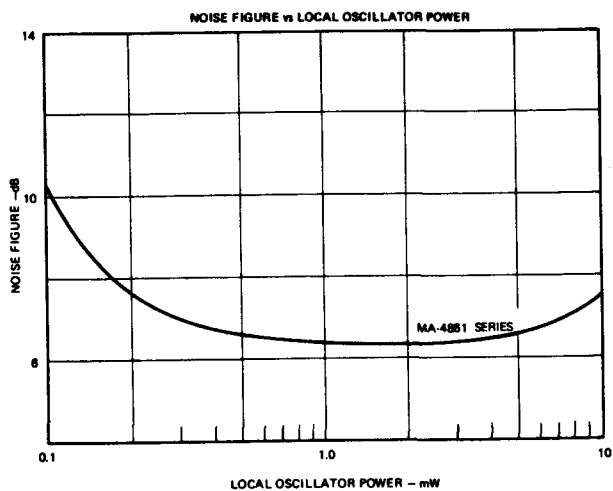

Medium Barrier Schottky Mixer Diodes

**L through X-Band,
Pico Miniature Glass Packages**
**S through Ku-Band,
MQM Packages**

CASE STYLES

54

100

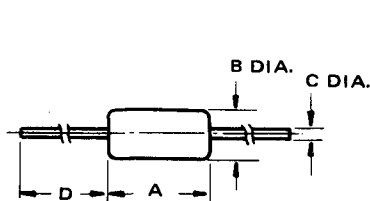

$L_p = 1.0 \text{ nH}$
 $C_p = .05 \text{ pF}$

DIM.	INCHES		MM	
	MIN.	MAX.	MIN.	MAX.
A	.145	.165	3.68	4.19
B	.068	.075	1.72	1.91
C	.014	.016	0.35	0.41
D	1.000	1.500	25.4	38.1

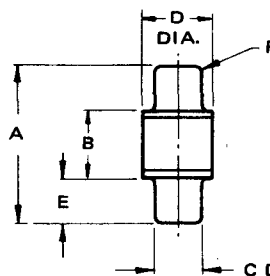

$L_p = .3 \text{ nH}$
 $C_p = .05 \text{ pF}$

DIM.	INCHES		MM	
	MIN.	MAX.	MIN.	MAX.
A	.197	.207	5.00	5.26
B	.070	.082	1.78	2.08
C	.060	.064	1.52	1.63
D	—	.084	—	2.13
E	.062	REF.	1.57	REF.
F	—	.012	—	0.30

Not to scale.

MAXIMUM RATINGS

(@ 25°C, unless otherwise specified)

DC Current:

L-Band Diodes	200 mA
S-Band Diodes	150 mA
X-Band Diodes	100 mA
Ku-Band Diodes	60 mA
Reverse Voltage	3 Volts, Min.

Temperature:

Operating	-65 to +150°C
Storage	-65 to +175°C

ENVIRONMENTAL RATINGS PER MIL-STD-750

	Method	Levels
Temperature Storage	1031	See Max. Ratings
Temperature Operating	—	See Max. Ratings
Temperature Cycling	1051	5 Cycles, -65 to +150°C
Shock	2016	500 g's
Vibration	2056	20 g's
Constant Acceleration	2006	20,000 g's
Humidity	1021	10 Days

ELECTRICAL SPECIFICATIONS @ $T_A = 25^\circ\text{C}$

MIXER DIODES

Model ¹ Number	Case Style	Test Frequency GHz	Max. ² Noise Figure dB	IF ² Impedance	
				Max. ² VSWR	Ohms
MA-4882	54	1.0	5.5	1.5	125-250
MA-4883	54	1.0	6.5	1.6	125-250
MA-4853	54	3.0	5.5	1.5	125-250
MA-4852	54	3.0	6.5	1.5	125-250
MA-4851	54	3.0	7.5	2.0	125-250
MA-4856	54	9.3	7.5	1.8	200-400
MA-4855	54	9.3	8.5	2.0	200-400
MA-40003	100	3.0	5.5	1.6	200-400
MA-40002	100	3.0	6.0	1.6	200-400
MA-40001	100	3.0	6.5	1.8	200-400
MA-40009	100	9.3	6.0	1.6	200-500
MA-40008	100	9.3	6.5	1.6	200-500
MA-40007	100	9.3	7.0	1.6	200-500
MA-40006	100	9.3	8.0	1.8	200-500



MICROWAVE ASSOCIATES, INC. BURLINGTON, MASSACHUSETTS

(Continued)

Model ¹ Number	Case Style	Test Frequency GHz	Max. ² Noise Figure dB	Max. ² VSWR	IF ² Impedance Ohms
MA-40015	100	16.0	6.5	1.6	200-500
MA-40014	100	16.0	7.0	1.6	200-500
MA-40013	100	16.0	7.5	1.6	200-500
MA-40012	100	16.0	8.0	1.8	200-500

NOTES:

1. Matched mixer diode pairs are available by adding the suffix "M". Matching criteria for pairs: $\Delta L_C = 0.3$ dB Max.; $\Delta Z_{IF} = 25$ Ohms Max.
2. $P_{LO} = 1.0$ mW; $NF_{IF} = 1.5$ dB Max.; $F_{IF} = 30$ MHz; $R_L = 16$ Ohms; Single Sideband Noise Figure

TYPICAL PERFORMANCE CURVES

Change in R.F. Impedance vs. Local Oscillator Power

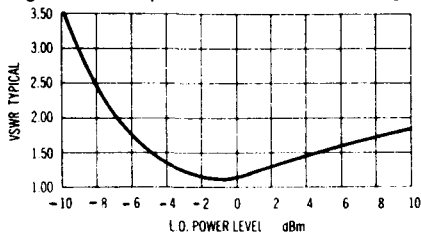

Noise Figure Change vs. Local Oscillator Power Level

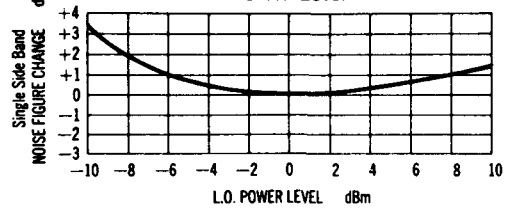

Change in R.F. Impedance vs. Temperature

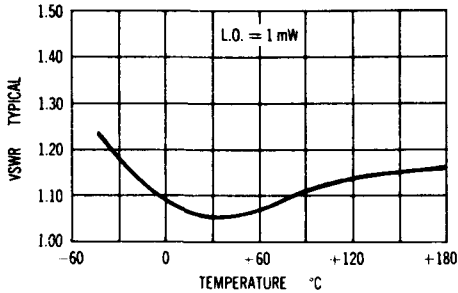

Noise Figure vs. Frequency

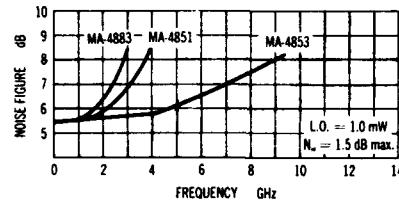

Noise Figure vs. Frequency

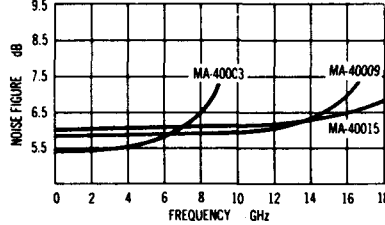

Z_{IF} vs. Local Oscillator Power Level for MA-40007

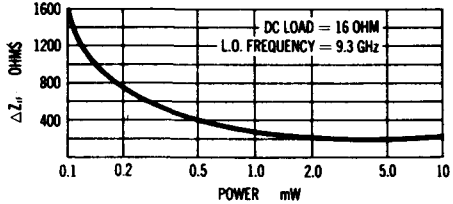

Flicker Noise Characteristics for MA-40006 at 25°C

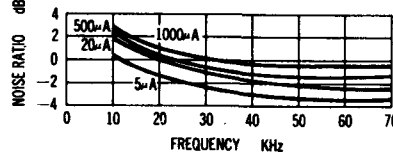

ΔZ_{IF} vs. Temperature for MA-40007

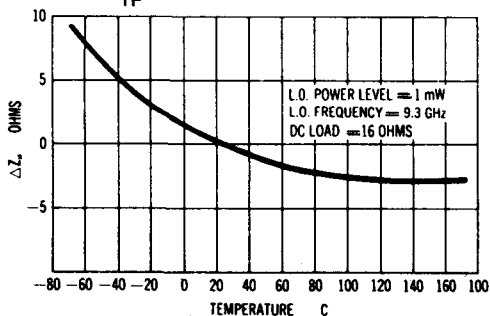

Noise Figure vs. Temperature for MA-40006

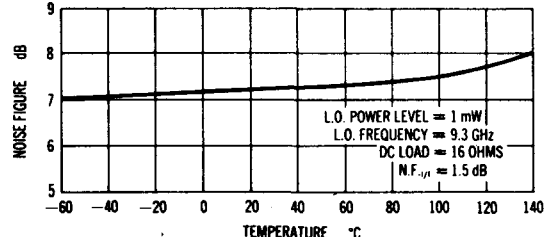

Medium Barrier Schottky Mixer Diodes

Stripline Package Series

MA-40033, MA-40034, MA-40035

CASE STYLE 137

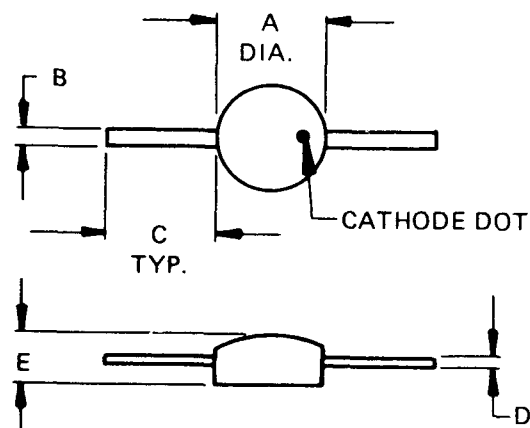

DIMENSIONS

DIM.	INCHES		MM	
	MIN.	MAX.	MIN.	MAX.
A	.090	.110	2,29	2,54
B	.018	.022	0,46	0,56
C	.095	.105	2,41	2,67
D	.003	.005	0,08	0,13
E	—	.050	—	1,27

MAXIMUM RATINGS (@ 25°C)

Incident RF CW Power	100 mW	Temperature:	
Incident RF Peak Pulse Power (3 ns Max. pulse width, 1000 pps)	2.0 watts		Operating
DC Forward Current	50 mA	Storage	-65 to +125°C

TYPICAL ELECTRICAL PARAMETERS

All Models

Package Capacitance ³ (C _p)	.2 pF	Junction Capacitance ³ (C _j)	0.1 pF
Series Resistance (R _s)	8 Ω	Breakdown Voltage ³ (V _B)	3.0 V

ELECTRICAL CHARACTERISTICS @ T_A = 25°C

Model ² Number	Case Style	Test Frequency GHz	Max. ¹ Noise Figure dB	Max. VSWR	IF Impedance Ohms
MA-40033	137	6.0	5.5	1.5	200 — 500
MA-40034	137	6.0	6.0	1.5	200 — 500
MA-40035	137	6.0	7.0	2.0	200 — 500

NOTES:

- Test Conditions: Noise figure is single sideband; measured with 30 MHz IF N_{if} = 1.5 dB max. P_{LO} = 1.0 mW; excess gas tube noise = 15.2 dB; R_L = 16 Ohms.
- All units available as matched pairs by adding suffix "M". Matching criteria: ΔNF = .3 dB max.; ΔZ_{IF} = 25 Ohms max.
- Breakdown voltage is measured at -10 μA. Capacitance is measured at 1 MHz.

 **MICROWAVE ASSOCIATES, INC.** BURLINGTON, MASSACHUSETTS

TYPICAL PERFORMANCE CURVES

TYPICAL NOISE FIGURE VS. LOCAL OSCILLATOR POWER
MA-40035

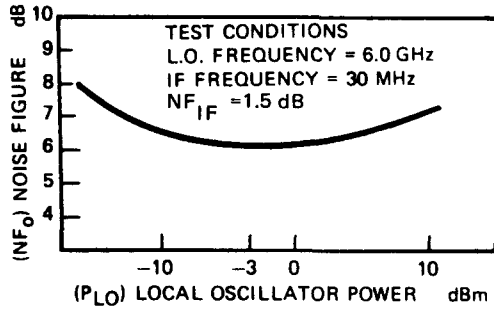

TYPICAL NOISE FIGURE VS. FREQUENCY MA-40034

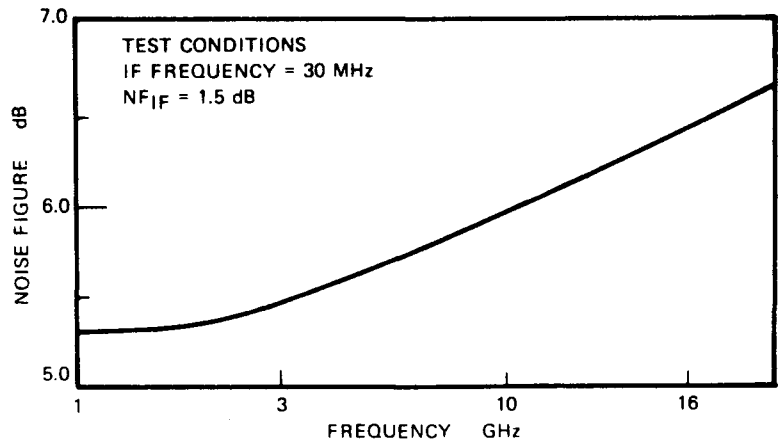

TYPICAL IF IMPEDANCE VS. L.O. POWER LEVEL

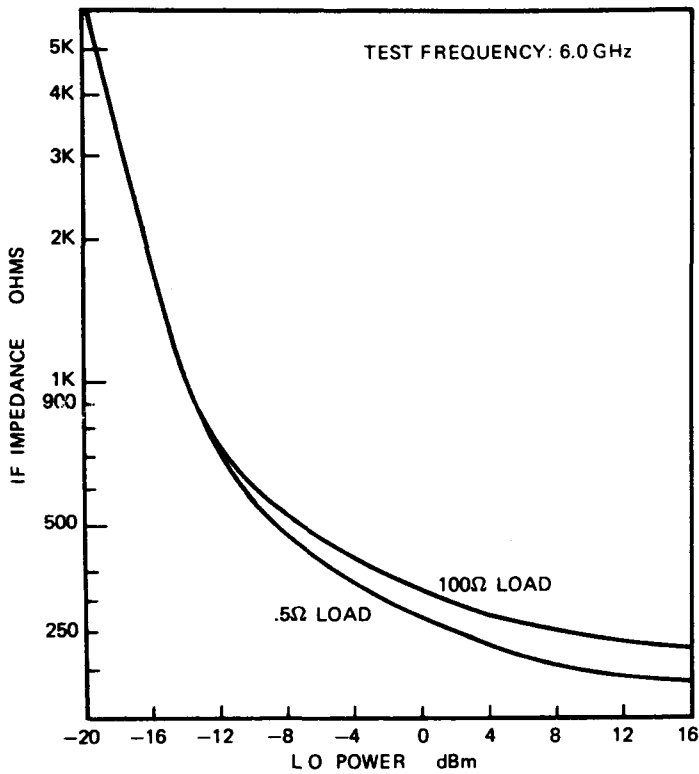

FORWARD CURRENT VS. FORWARD VOLTAGE

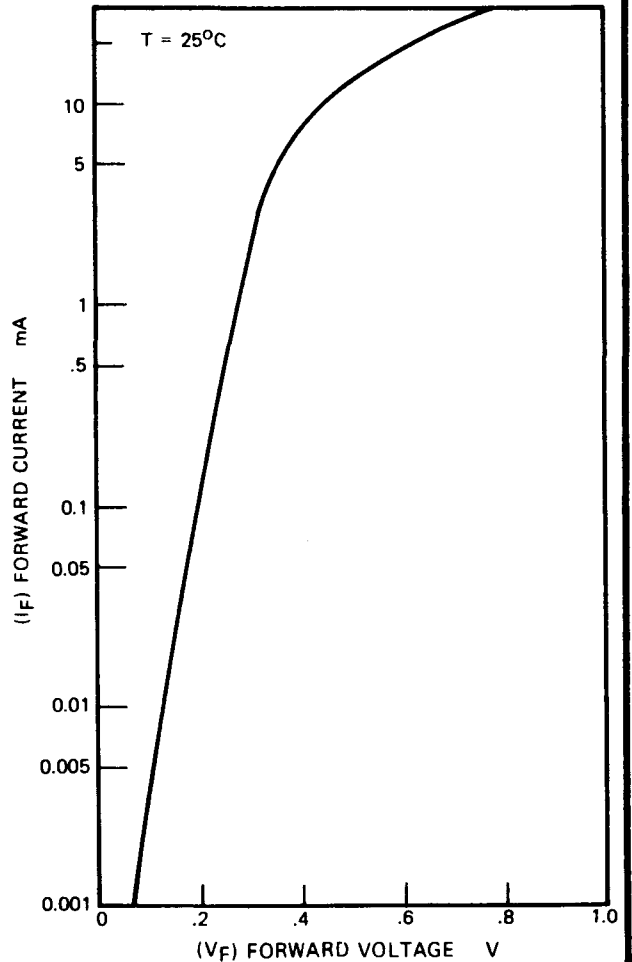

Medium Barrier Schottky Mixer Diodes

Schottky Diode Replacements for IN21, IN23 Series

CASE STYLE

3

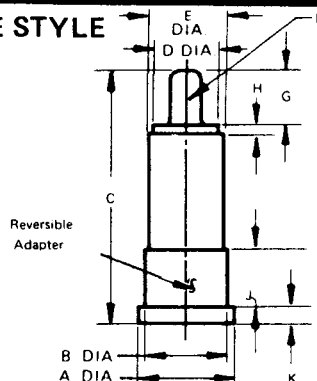

DIM.	INCHES		MM	
	MIN.	MAX.	MIN.	MAX.
A	0.292	0.296	7.417	7.618
B	0.246	0.250	6.248	6.350
C	0.753	0.783	19.13	19.89
D	0.195	0.225	4.953	5.715
E	-	0.240	-	6.096
F	0.030	0.046	0.766	1.168
G	0.092	0.094	2.336	2.387
H	-	0.030	-	0.762
J	0.193	0.199	4.902	5.054
K	0.047	0.057	1.194	1.448

MAXIMUM RATINGS

(@ 25°C, unless otherwise specified)

	MA-40051 Series	MA-40071 Series
Incident RF CW Power	100 mW	100 mW
DC Current	60 mW	50 mA
Reverse Voltage	3 V	3 V
Temperature Range:		
Operating	-65 to +150°C	-65 to +150°C
Storage	-65 to +175°C	-65 to +175°C

ENVIRONMENTAL RATINGS PER MIL-STD-750

	Method	Levels
Temperature, Storage	1031	See Max. Ratings
Temperature, Operating	—	See Max. Ratings
Temperature, Cycling	1051	5 Cycles, -65 to +150°C
Shock	2016	500 g's
Vibration	2056	15 g's
Constant Acceleration	2006	20,000 g's
Moisture Resistance	1021	10 Days

Pulse Burnout:

	3.060 GHz	9.375 GHz
Frequency	3.060 GHz	9.375 GHz
R_L	100Ω	100Ω
Pulsewidth	3 ns	3 ns
Incident Peak Power	2W	2W
Pulse Frequency	1 kHz	1 kHz

ELECTRICAL SPECIFICATIONS @ $T_A = 25^\circ\text{C}$

Model ¹ Number	Case Style	Max. Noise ² Figure dB	Max. Conversion ³ Loss dB	Max. Output ⁴ Noise Ratio	Max. VSWR ⁵	IF ⁶ Impedance Ohms
S-Band (Test Frequency - 3.060 GHz)						
MA-40051E	3	7.0	5.5	1.8	2.0	300-500
MA-40051F	3	6.0	5.5	1.5	1.5	350-450
MA-40051G	3	5.5	5.0	1.5	1.5	350-450
MA-40051H	3	5.0	5.0	1.5	1.5	350-450
S Through X-Band (Test Frequency - 9.375 GHz)						
MA-40071E	3	7.5	6.0	1.4	2.0	300-500
MA-40071F	3	7.0	6.0	1.4	1.5	325-475
MA-40071G	3	6.5	5.5	1.4	1.5	325-475
MA-40071H	3	6.0	5.0	1.4	1.5	325-475
MA-40071I	3	5.5	4.5	1.4	1.5	325-475

NOTES:

- All units are also available as single reverse, matched pair forward, and matched pair forward and reverse by adding "R", "M" or "MR" respectively to the base type number. Matching criteria for pairs: $\Delta NF = 0.3$ dB Max. and $\Delta Z_{IF} = 25$ Ohms Max.
- The specified noise figure is a single sideband measurement made at the stated frequency with a 30 MHz IF and a 1.5 dB

nominal IF noise figure. The local oscillator power is 1.0 mW, Nom. and $R_L = 100$ ohms. The MA-40051 Series is tested in the JAN 264 mount, and the MA-40071 Series in the JAN 105 mount.

- Amplitude Modulation Method.
- Calculated from $NF = L_C (NF_{IF} + N_{RO} - 1)$.
- $I_{RECT.} = 1.0$ mA.
- AC METHOD IF = 60 to 100 cps.



MICROWAVE ASSOCIATES, INC. BURLINGTON, MASSACHUSETTS

TYPICAL PERFORMANCE CURVES

NOISE FIGURE VS. L.O. POWER
MA40051 AND 1N21

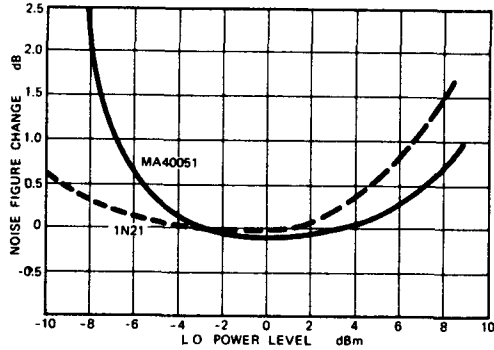

NOISE FIGURE VS. L.O. POWER
MA40071 AND 1N23

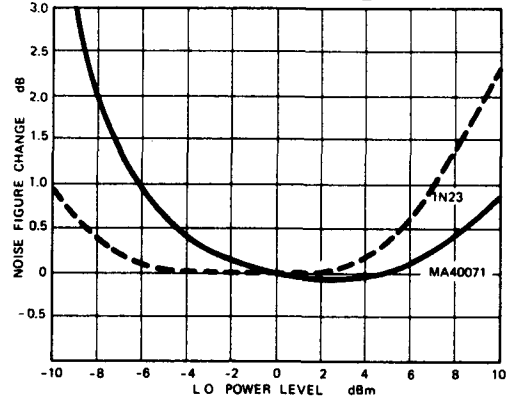

NOISE FIGURE VS. TEMPERATURE
MA40051 AND 1N21

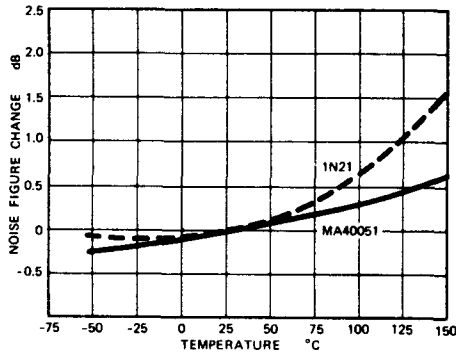

NOISE FIGURE VS. TEMPERATURE
MA40071 AND 1N23

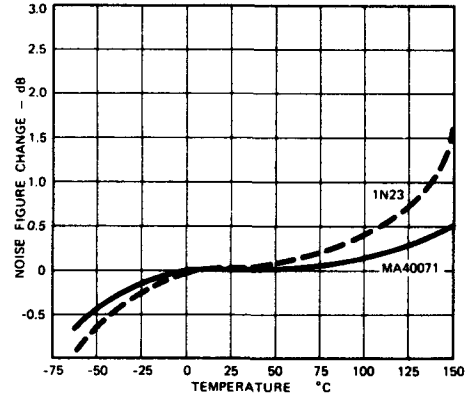

IF IMPEDANCE VS. L.O. POWER
MA40071 AND 1N23

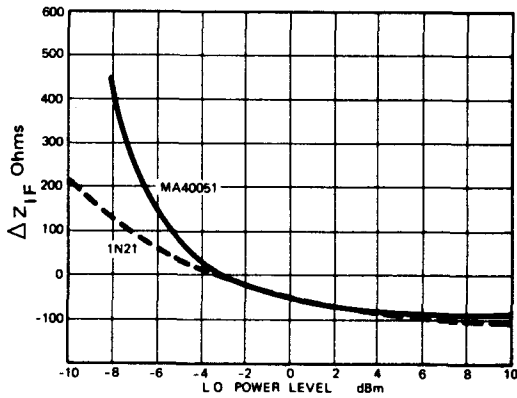

IF IMPEDANCE VS. L.O. POWER
MA40071 AND 1N23

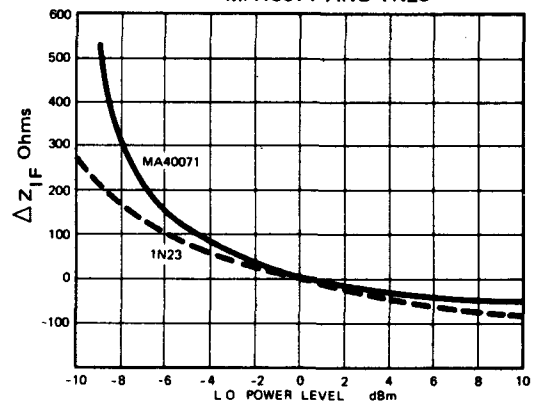

IF IMPEDANCE VS. TEMPERATURE
MA40071 AND 1N23

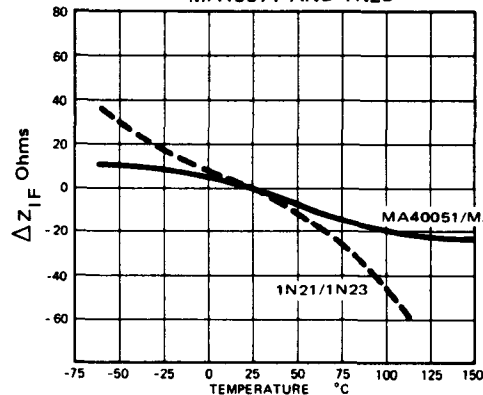

TYPICAL PERFORMANCE CURVES (Continued)

VSWR VS. L.O POWER
MA40051 AND 1N21

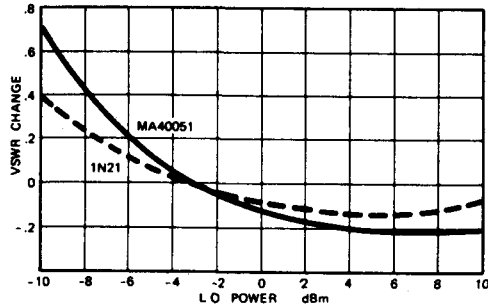

VSWR VS. L.O POWER
MA40071 AND 1N23

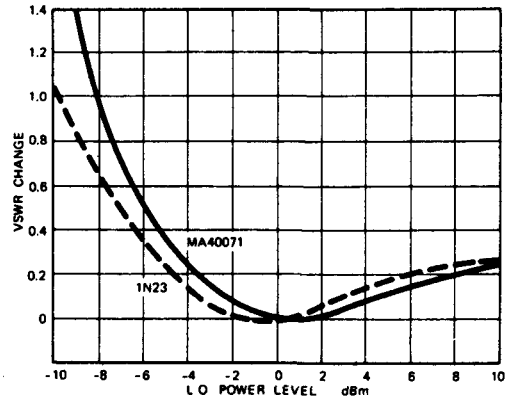

VSWR VS. TEMPERATURE
MA40051 AND 1N21

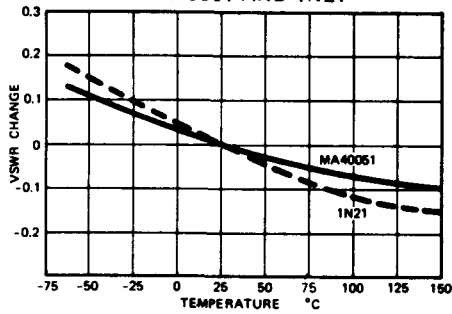

VSWR VS. TEMPERATURE
MA40071 AND 1N23

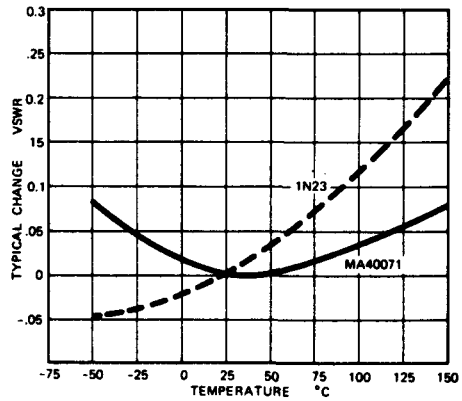

NOISE RATIO VS. I.F FREQUENCY
MA40051 AND 1N21

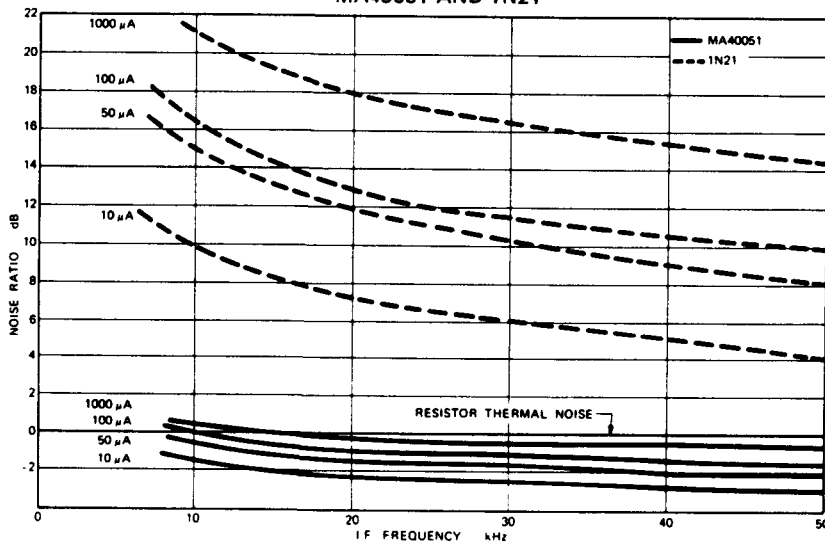

NOISE RATIO VS. I.F FREQUENCY
MA40071, 1N23 AND BACK DIODE, L.O. BIAS

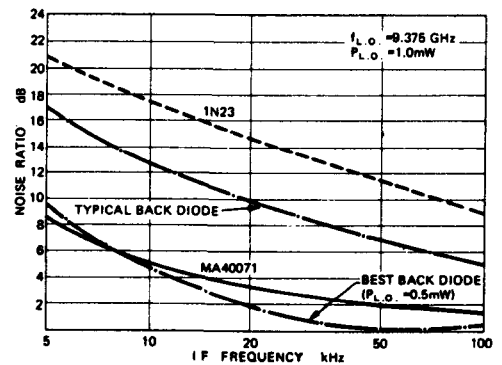

TYPICAL PERFORMANCE CURVES (Continued)

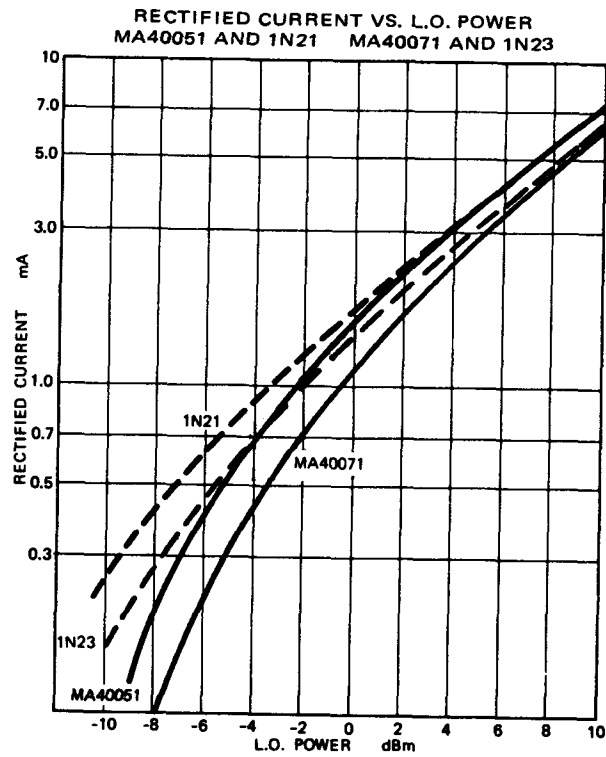

RF IMPEDANCE VS. FREQUENCY
MA40051 AND 1N21
(Referenced to $50 + j0$ Ohms)

RF IMPEDANCE VS. FREQUENCY
MA40071 AND 1N23
(Referenced to $50 + j0$ Ohms)

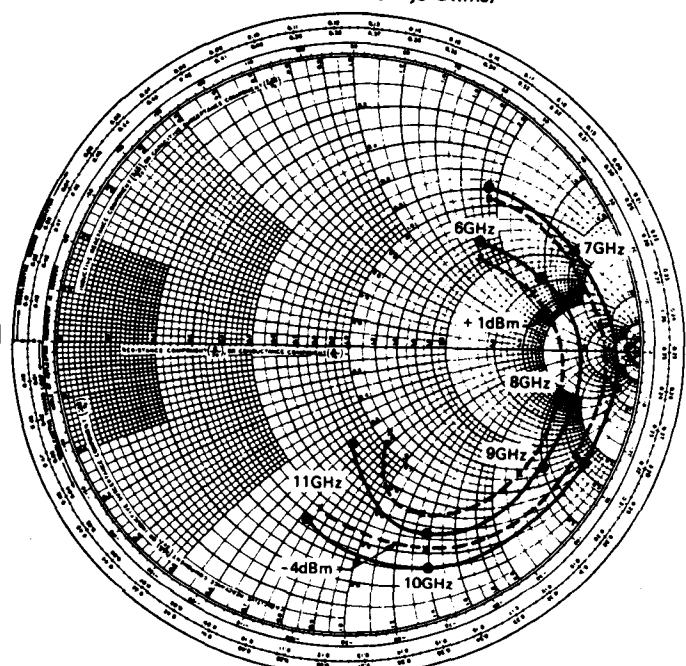
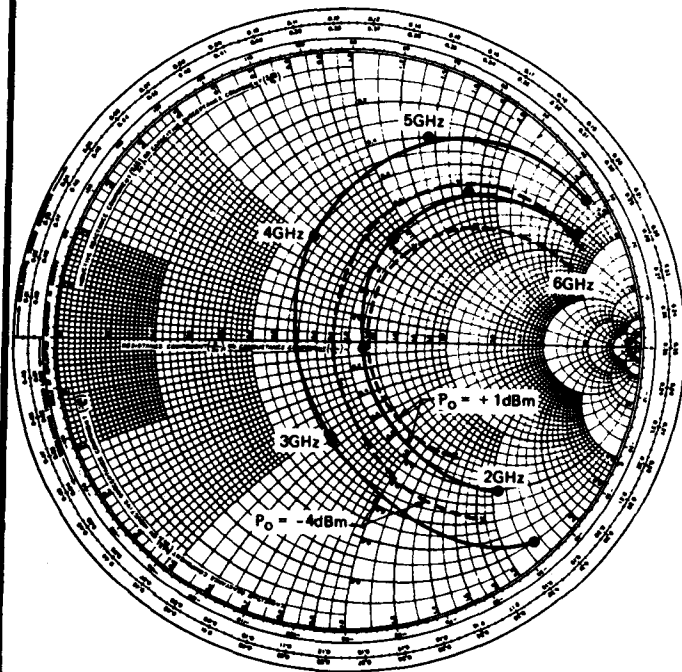

— TYPICAL MA40051
- - - TYPICAL 1N21

— TYPICAL 1N23
- - - TYPICAL MA40071

All specifications are subject to change without notice.

Low and Medium Barrier Schottky Mixer Diodes

MA40100 SERIES—LOW BARRIER

MA40150 SERIES—MEDIUM BARRIER

Bulletin 4211

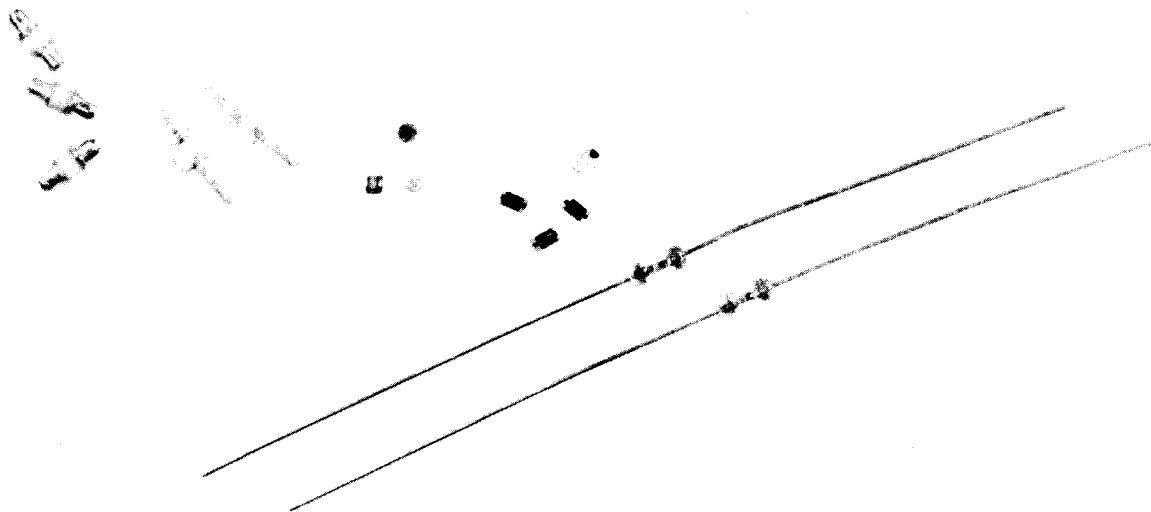

DESCRIPTION

These two families of Schottky mixer diodes are offered in all standard diode package styles. The diodes are silicon Schottky barrier diodes of planar epitaxial passivated chip construction. The manufacturing technique produces devices with extremely uniform electrical characteristics. Uniform RF impedances from diode to diode are provided by the very tight tolerance in junction capacitance.

High reliability versions screened to MIL-STD-750 are available. The tables at the rear of this bulletin give the recommended screening and inspection procedures.

APPLICATIONS

The MA-40100 series of low barrier Schottky diodes, show optimum performance at -3 dBm, and show less than 1 dB noise figure degradation at -10 dBm. They are recommended for starved LO applications.

The MA-40150 series of medium barrier Schottky diodes, show optimum performance at 0 dBm and are recommended for use where moderate LO power is available.

SPECIFICATIONS

Electrical Characteristics @ 25°C

L- through Ku-Band

Schottky Barrier Mixer Packaged Diodes¹

Frequency Band	Low Barrier ¹ Model Number	Medium Barrier ¹ Model Number	Case ² Style	Test Frequency GHz	Max. ⁴ Noise Figure dB	Max. VSWR	IF ⁵ Impedance Ohms
L-through-X	MA-40100	MA-40150	119	9.375	6.0	1.5	250-450
	MA-40101	MA-40151	119	9.375	6.5	1.5	250-450
	MA-40102	MA-40152	119	9.375	7.0	2.0	250-450
	MA-40103	MA-40153	54	9.375	6.5	1.5	250-450
	MA-40104	MA-40154	54	9.375	7.0	2.0	250-450
	MA-40105	MA-40155	120	9.375	6.0	1.5	250-450
	MA-40106	MA-40156	120	9.375	6.5	1.5	250-450
	MA-40107	MA-40157	120	9.375	7.0	2.0	250-450
Ku	MA-40110	MA-40160	119	16.0	6.5	1.5	200-450
	MA-40111	MA-40161	119	16.0	7.0	2.0	200-450
	MA-40115	MA-40162	120	16.0	6.5	1.5	200-450
	MA-40116	MA-40163	120	16.0	7.0	2.0	200-450

Schottky Barrier Mixer Diode Chips and Carriers for Microwave Hybrid Circuits

Low Barrier ¹ Model Number	Medium Barrier ¹ Model Number	Case Style	Min. Breakdown Voltage @ 10 μ A Volts		Typ. Forward Voltage @ 1 mA Volts		Max. ³ Total Capacitance @ V _R = 0 pF	Typ. Noise Figure @ 9.375 GHz dB
			Low	Med	Low	Med.		
MA-40140	MA-40170	135	2	4	.3	.4	.15	6.5
MA-40121	MA-40171	81	2	4	.3	.4	.30	6.5
MA-40122	MA-40172	121	2	4	.3	.4	.20	6.5
MA-40123	MA-40173	185	2	4	.3	.4	.30	6.5
MA-40124	MA-40174	185	2	4	.3	.4	.15	6.5
MA-40126	MA-40176	186	2	4	.3	.4	.35	6.0
MA-40127	MA-40177	186	2	4	.3	.4	.35	6.5
MA-40128	MA-40178	186	2	4	.3	.4	.35	7.0

- NOTES: 1. All units available as matched pairs by adding the suffix "M". Matching criteria for packaged pairs: $\Delta NF_0 = 0.3$ dB, Max., $\Delta Z_{if} = 25$ ohms, Max. Matching criteria for chips: $\Delta C = .05$ pF, Max. @ V_R=0; $\Delta V_F=10$ mV Max. @ I_F = 1.0 mA.
2. The diodes are thermo-compression bonded in all case styles except in case style 54. The max. solder temperature for all Case Styles except 120 is 230°C for 5 seconds. For Case Style 120, Max. solder temperature is 200°C for 5 seconds.
3. Measurement frequency = 1 MHz.
4. Test Condition: Noise figure is single sideband measured with 30 MHz IF, NF_{IF} = 1.5 dB, Max., and local oscillator power = 1.0 mW; excess gas tube noise at 9.375 GHz = 15.3 \pm 0.5 dB at 16.0 GHz = 16.0 \pm 0.5 dB.
5. Test frequency: 1 kHz

Maximum Ratings @ 25°C

Incident RF CW Power	100 mW	DC Forward Current	40 mA
Incident RF Peak Pulse Power (3 ns pulse width, 1000 pps)	2.0 Watts	Temperature:	
		Operating	-65 to +150°C
		Storage	-65 to +150°C

MIL-STD-750

TEST	METHOD	CONDITIONS
Temperature, Storage	1031	-65°C to +150°C
Temperature, Operating	1026	-65°C to +150°C
Temperature, Cycling	1051	5 cycles, -65°C to +125°C
Thermal Shock	1056	5 cycles, 0°C to +100°C
Moisture Resistance	1021	10 days, 90-98% RH, -10°C to 65°C
Shock	2016	5 blows, X ₁ , Y ₁ , Z ₂ at 1500 G
Vibration Fatigue	2046	32 hours each X, Y, Z at 15 G
Vibration Variable Frequency Constant Acceleration	2056 2006	Four 4 minute cycles, X, Y, Z at 20 G min. 100 - 2000 Hz 1 minute each X ₁ , Y ₁ , Z ₂ at 20,000 G

Typical Parameter Values

Case Style	54	81	119	120	121	135	185	186
Package Capacitance - C _p	.05 pF	.20 pF	.15 pF	.13 pF	0.20 pF	-	-	0.2 pF
Package Inductance - L _p	1 nH	.5 nH	.5 nH	.4 nH	-	-	-	.4 nH
Series Resistance - R _s	8 Ω	8 Ω	8 Ω	8 Ω	8 Ω	8 Ω	8 Ω	8 Ω
Junction Capacitance - C _j	.1 pF	.1 pF	.1 pF	.1 pF	.1 pF	.1 pF	.1 pF	.1 pF

TYPICAL PERFORMANCE CURVES

TYPICAL FORWARD CURRENT VS. FORWARD VOLTAGE

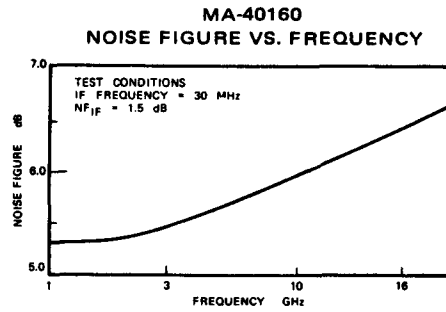
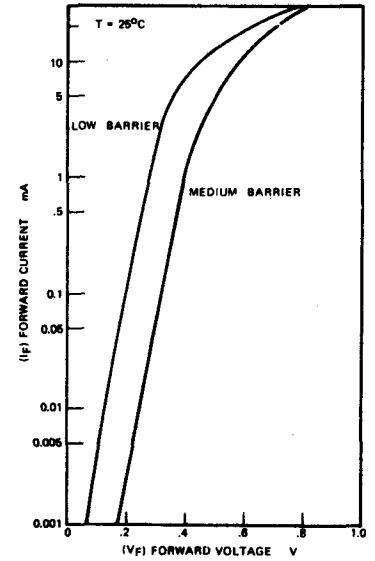
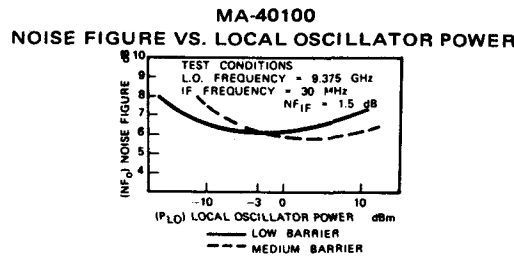
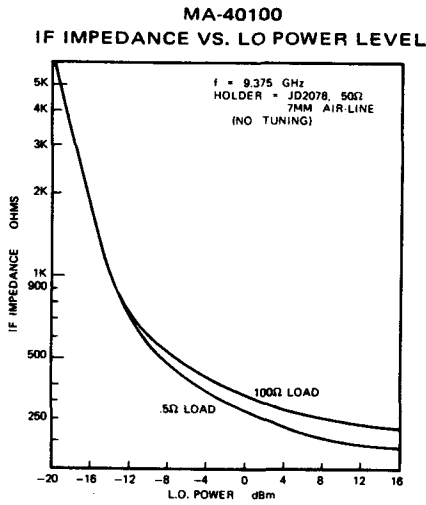

CASE STYLES

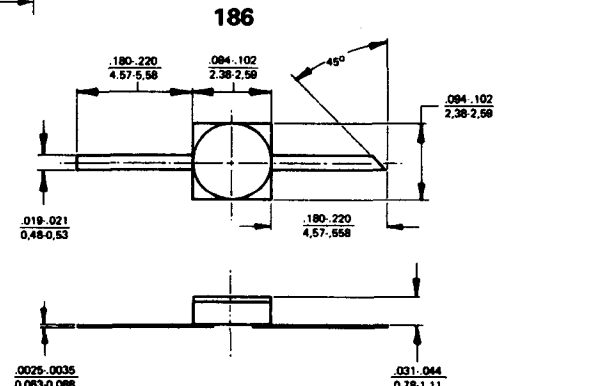
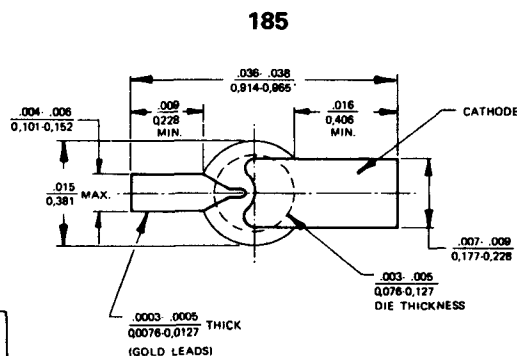
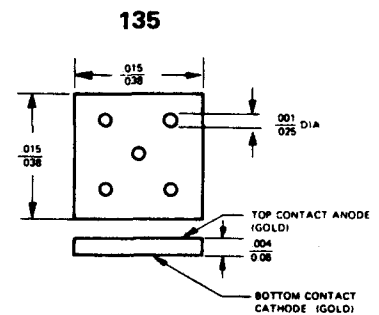
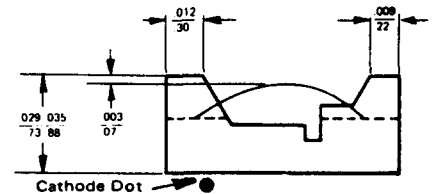
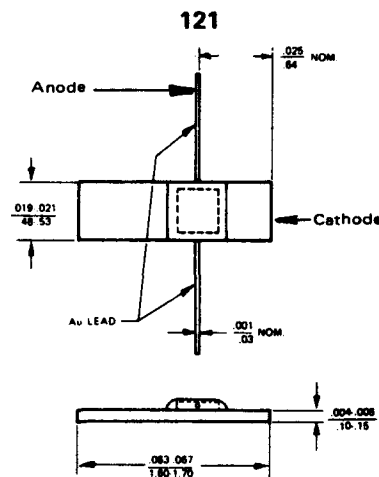
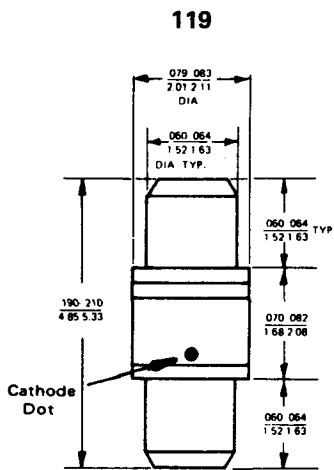
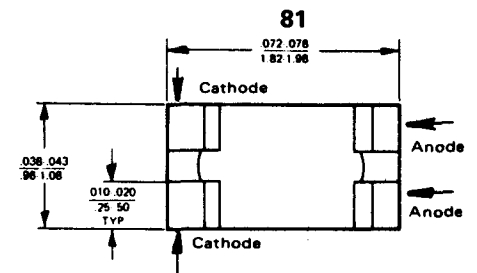
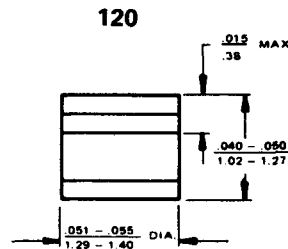
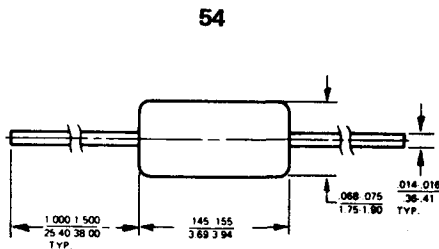

KEY
 inch
 mm

Not to scale.

RECEIVING DIODES

TX Preconditioning and Screening—100%

Examination or Test	MIL-STD-750 Methods	Test Conditions
1. Electrical Test		
2. High Temperature Storage	1031	t = 168 hrs., T = 150°C
3. Thermal Shock (Temperature Cycling) 10 Cycles	1051	-65°C to +150°C,
4. Fine Leak Test	1071	Cond. H
5. Gross Leak Test	1071	Cond. C, Step 1
6. Constant Acceleration	2006	20,000 Gs, Y ₁ only
7. Radiographic Inspection	2076	
8. Electrical Test: V _F @ 10 mA, C _O @ V = 0V, F = 1 MHz		
9. Burn-In	1038	Cond. B, t = 168 hrs. T = 100°C, I _F = 10 mA Max. ΔV _F = ±10% Max. ΔC _T = ±10%
10. Electrical Test: V _F @ 10 mA, C _O @ V = 0V, F = 1.0 MHz		
11. Calculate Drift, ΔV _F and ΔC _T		
12. Final Visual	2071	

Group B Inspection

Examination or Test	MIL-STD-750		LTPD	Symbol
	Method	Test Conditions		
Subgroup 1			15	
Physical Dimensions	2066	Per Case Style in this Bulletin		
Subgroup 2			20	
Solderability	2026	Unit Aging		
Subgroup 3			10	
Temperature Cycle (10 cycles)	1051	-65°C to +150°C		
Thermal Shock	1056	Cond. A		
Hermetic Seal, Fine Leak	1071	Cond. H		
Hermetic Seal, Gross Leak	1071	Cond. C, Step 1		
Moisture Resistance	1021			
<u>End Points:</u>				
Noise Figure		See Page 34		NF
IF Impedance		See Page 34		Z _{IF}
Subgroup 4			10	
Shock — Non-operating	2016	1500G, t = 0.5 ms, 5 blows, X ₁ , Y ₁ , Y ₂		
Vibration Variable Frequency	2056	Non-Operating		
Constant Acceleration	2006	20,000 Gs, X ₁ , Y ₁ , Y ₂		
<u>End Points:</u> Same as Subgroup 3				
Subgroup 5			λ = 5	
High Temperature Life	1031	T _A = 150°C, t = 1000 hrs.		
<u>End Points:</u> Per Step 8, Table III Drift Criteria same as Step 11, Table III				
Subgroup 6			λ = 5	
Steady State Operating Life	1026	I _F = 10 mA, T = 25°C, t = 1000 hrs.		
<u>End Points:</u> Per Step 8, Table III Drift Criteria same as Step 11, Table III				

Silicon Beam Lead Schottky Diodes

*Low and Medium Barrier
Mixer and Detector Beam Lead Diodes*

Bulletin 4213

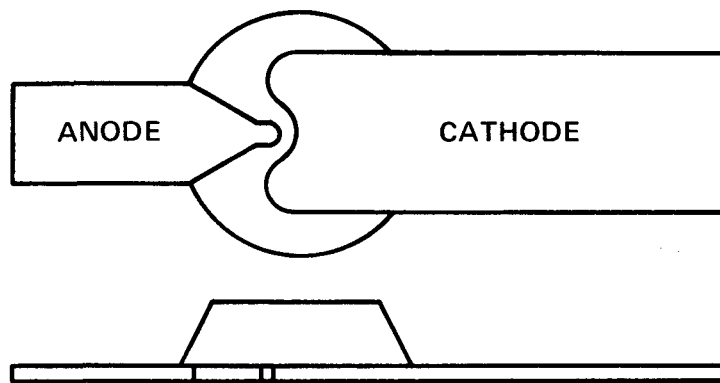

FEATURES

- Planar Construction (Surface Oriented Diode)
- Silicon Nitride Passivation
- Extremely Strong Beam Construction
- High Process Uniformity
- Low Noise Figure (6 dB Typical at 10 GHz)

APPLICATIONS

Beam Lead Diodes are specifically designed for stripline and microstrip circuit applications because they are planar devices. The Beam lead construction provides a device with extremely low parasitic reactances and precise process control insures repeatable RF performance from batch to batch.

Information on Beam Lead Bonding Techniques is available in M/A's Technical Report "Application and Handling of Chip and Hybrid-Chip Diodes for Integrated Circuits."

DESCRIPTION

Beam Lead Schottky Diodes are planar devices in which both the Schottky junction and the back contact are made accessible to a common surface so they may be contacted by the beam leads. The Schottky junction is passivated by silicon oxide and silicon nitride to give stable reliable performance. The diodes meet the humidity tests as specified in MIL STD 750, 1021 as well as burn-in life tests.

During the manufacturing process, gold beam leads are deposited onto a glass layer before the wafer is separated into individual diodes. This technique produces the exceptional beam strength characteristic of M/A Schottky Beam Leads.

SPECIFICATIONS

Mixer Characteristics @ $T_A = 25^\circ\text{C}$

Model Number	Max. Total Capacitance (pF) $V_A=0, F=1 \text{ MHz}$	Max. Forward Voltage @ 1 mA Volts	Min. Breakdown Voltage @ 10 μA Volts	Typical Series Resistance Ohms	Typical Single Side Band NF dB
MA-40123 (X-Band Low Barrier)	0.25	0.35	2	8	6.0
MA-40124 (Ku-Band Low Barrier)	0.15	0.35	2	8	6.5
MA-40173 (X-Band Medium Barrier)	0.25	0.40	3	8	6.0
MA-40174 (Ku-Band Medium Barrier)	0.15	0.40	3	8	6.5

Detector Characteristics @ $T_A = 25^\circ\text{C}$

	Parameter	Symbol	Typical Value	Units	Test Conditions
MA-40175	Tangential Sensitivity	T_{SS}	-55	dBm	$I_B = 25 \mu\text{A}$
Ku-Band	Detection Sensitivity	γ	7000	mV/mW	$V_{id} B_w = 2 \text{ MHz}$
Detector	Video Resistance	R_V	1400	Ω	$f = 9.375 \text{ GHz}$

Absolute Maximum Ratings

Incident RF Peak Pulse Power, $T_A = 25^\circ\text{C}$ (Note 1)	1W
Incident CW RF Power, $T_A = 25^\circ\text{C}$	300 mW
Operating Temperature Range	-60°C to $+150^\circ\text{C}$
Storage Temperature Range	-60°C to $+150^\circ\text{C}$
Maximum Pull On Any Lead	2 grams
Diode Mounting Temperature	220°C for 10 sec. max.

NOTE:

- 3 ns Max. pulse width, 1000 pps.

OUTLINE DRAWING

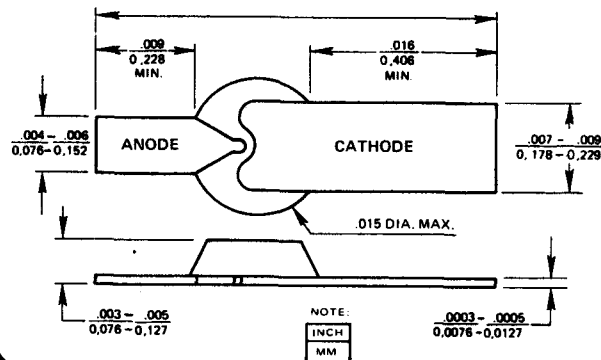
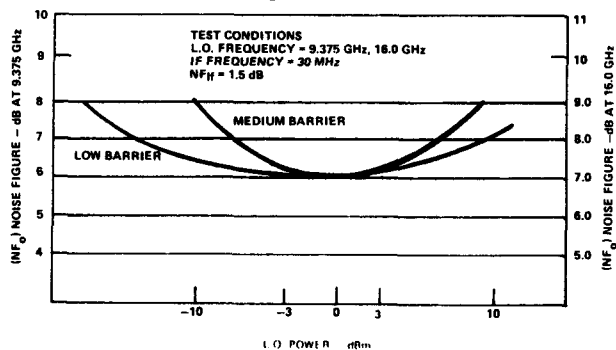

Figure 1 Noise Figure Vs. Local Oscillator Power



TYPICAL PERFORMANCE CURVES

Figure 2 Typical Forward Characteristics Low Barrier Diodes

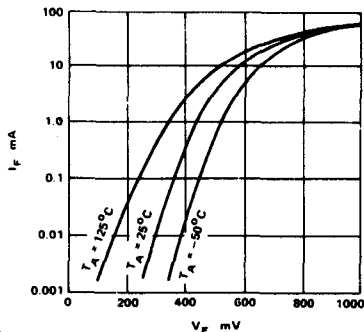

Figure 3 Typical Forward Characteristics Medium Barrier Diodes

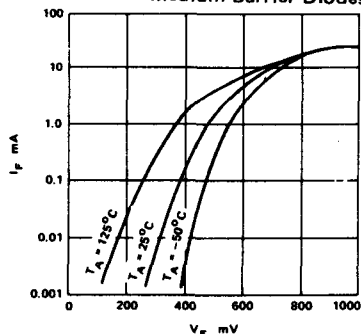
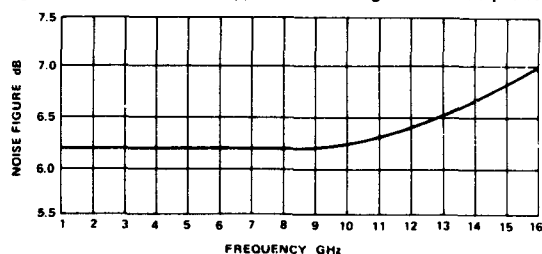

Figure 4 MA-40174 Typical Noise Figure Vs. Frequency



Detector Diode Characteristics

FIGURE OF MERIT (F. M.)

A Figure of Merit has been established to characterize video receivers:

$$\text{Figure of Merit} = M \frac{\beta R_V}{\sqrt{R_A + R_V}} \quad \text{where } \beta = \frac{\Delta I}{P_{in}}$$

where R_V is the dynamic resistance of the diode and is called video resistance, and R_A is a constant resistance representing the noise contribution due to amplifiers. The term $R_A \approx 1200\Omega$, but no longer seems to be valid for present low-noise transistor amplifiers. Figure of merit does not consider shot and flicker noise introduced by the bias current. Therefore, this method of characterization is of limited value in describing Schottky-Barrier diodes. Video detectors are presently being characterized by signal sensitivity types of measurement, i.e., amount of available signal power (in decibels referred to 1 mW) required to produce a specified signal-to-noise ratio. The various terms now used are minimum detectable signal (MDS), tangential signal sensitivity (TSS), nominal detectable signal (NDS) and noise equivalent power (NEP):

MINIMUM DETECTABLE SIGNAL (MDS)

The minimum detectable signal (MDS) is defined as the smallest signal which may be observed on an oscilloscope when its position along the trace is unknown. This corresponds to a signal-to-noise ratio of approximately unity and is a subjective measurement.

TANGENTIAL SIGNAL SENSITIVITY (TSS)

The Tangential Signal Sensitivity (TSS) is a direct measurement of signal-to-noise voltage in a detector receiver. The measurement is carried out with a pulse signal, the level of which is adjusted such that the highest noise peaks observed on an oscilloscope in the absence of signal are the same level as the lowest noise peaks in the presence of the signal. The condition is shown in Figure 1. The signal level thus determined gives the TSS value. TSS corresponds to a signal-to-noise ratio of approximately 2.5:1. Although the measurement is subjective and depends upon the operator, it is still most commonly used by industry.

Figure 1. Representation of Oscilloscope Display in Determining TSS.

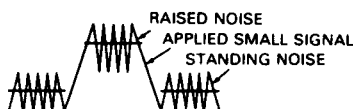

NOMINAL DETECTABLE SIGNAL (NDS)

The Nominal Detectable Signal (NDS) is defined as exactly that microwave power required to produce an output power equal to the noise power. This corresponds to a signal-to-noise ratio of unity.

$$\text{NDS} = \frac{Z}{\gamma} \sqrt{KTR_V \left[t_w + \frac{T_o}{T} \left(F_V - 1 \right) B + B_x \ln \frac{f_n}{f_1} \right]} \quad \text{where}$$

K = Boltzmann's constant
 T = absolute temperature
 R_V = video resistance
 T_o = room temperature
 t_w = white noise temperature ratio
 F_V = noise figure of video amplifier
 $B_x \ln f_n / f_1$ = Flicker noise

$$\text{If } F_V = 1 + (R_A/R_V), \text{ then } \text{NDS} = \frac{2}{M} \sqrt{KTB}$$

The TSS is found empirically to be 4 dB above NDS, under ordinary conditions. The various parameters TSS, MDS, and NDS are all dependent upon the amplifier bandwidth, usually varying as the square root of the bandwidth. Thus the bandwidth at which measurements are made must be stated when specifying the detector. The usual value is a 2-MHz video bandwidth. The attached curve shows the effect of video bandwidth on TSS.

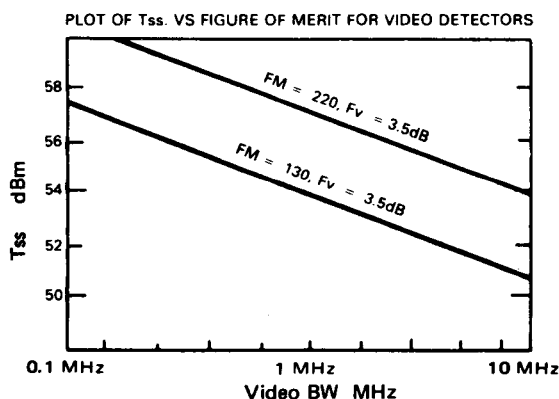

SELECTION GUIDE--SILICON POINT CONTACT DETECTOR DIODES IN HERMETIC PACKAGES

Test Frequency	3 GHz				10 GHz				16 GHz		
	Case Style	Glass DO-7 4	Glass 54	Ceramic DO-23 3	MQM 100	Glass DO-7 4	Glass 54	Ceramic DO-23 3	MQM 100	Coaxial DO-37 11	MQM 100
40											
45	MA-4123	MA-41510			1N833	MA-41513					
48	MA-4123A	MA-41511			1N833A	MA-41514					MA-41225
49			MA-417								
50	MA-4139 1N4379	MA-41512	MA-4142	MA-41223	1N833B	MA-41515	1N1611 MA-418A	MA-41223			
51							MA-461A				
52			MA-4142A				1N1611B MA-461B		MA-4116	MA-4122A	
54				MA-41222							
55								MA-41222			
Comment	General Purpose Detector	Best Bandwidth	Waveguide Detector	Broad Band	General Purpose	Best Bandwidth	Waveguide Detector	Broad Band	Waveguide Detector	Broad Band	

NOTE:

1. Video Bandwidth = 2 MHz.
2. "DO" Numbers are JEDEC outlines.



MICROWAVE ASSOCIATES, INC. BURLINGTON, MASSACHUSETTS

Point Contact Diodes for Detector Applications

Bulletin 4151

GLASS TYPES

S-Band

X-Band

MQM TYPES

S-Band

X-Band

Ku-Band

K-Band

CARTRIDGE TYPES

X-Band

ADDITIONAL TYPES

UHF-X Band

Point Contact Detector Diodes Glass

S-Band Series

CASE STYLES

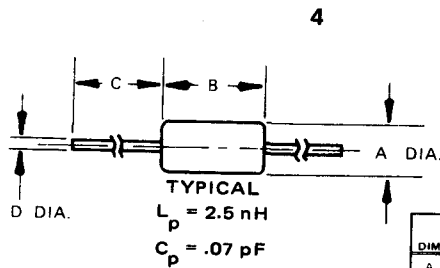

DIM.	INCHES		MM	
	MIN.	MAX.	MIN.	MAX.
A	0.085	0.107	2.16	2.72
B	0.210	0.300	5.34	7.62
C		1.000		25.4
D	0.018	0.022	0.46	0.56

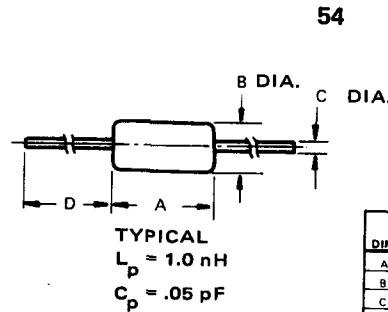

DIM.	INCHES		MM	
	MIN.	MAX.	MIN.	MAX.
A	.145	.165	3.68	4.19
B	.068	.075	1.72	1.91
C	.014	.018	0.35	0.41
D	1.000	1.500	25.4	38.1

Not to scale.

MAXIMUM RATINGS @ 25°C

Incident RF CW Power	2.0 W
Incident RF Peak Pulse Power (3 ns Max pulse width, 1000 pps)	100 mW
DC Current ⁴	10 mA

ELECTRICAL CHARACTERISTICS @ $T_A = 25^\circ\text{C}$

Model ¹ Number	Case Style	Test Freq. GHz	Min. ^{2, 3}	Video Impedance K ohms	Burnout ⁴ Rating Ergs
			Tangential Sensitivity -dBm		
MA-4123	4	3.060	45	5-25	5
MA-4123A	4	3.060	48	5-25	5
MA-4123B	4	3.060	50	4.5-18	5
MA-41510	54	3.060	45	4.5-18	5
MA-41511	54	3.060	48	4.5-18	5
MA-41512	54	3.060	50	4.5-18	5

- NOTES:
- Matched pairs are available by adding suffix M with output voltage matched $\pm 0.5 \text{ dB}$ and $R_v \pm 10\%$ at -30 dBm .
 - Bandwidth of IF amplifier = 2 MHz; $NF_{IF} = 3.5 \text{ dB Max.}$ with an input impedance of 10,000 ohms. Low frequency cut-off is approximately 1.0 kHz.
 - Holder is JAN 264 with adaptor for MA-4123 thru MA-4123B, and JD 1908 for MA-41510 thru MA-41512.
 - Adequate Heat Sink Required.

 **MICROWAVE ASSOCIATES, INC.** BURLINGTON, MASSACHUSETTS

Point Contact Detector Diodes Glass

X-Band Series

CASE STYLES

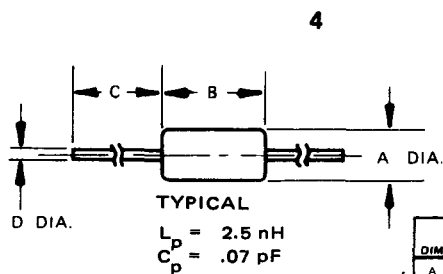

DIM.	INCHES		MM	
	MIN.	MAX.	MIN.	MAX.
A	0.085	0.107	2.16	2.72
B	0.230	0.300	5.84	7.62
C		1.000		25.4
D	0.018	0.022	0.46	0.56

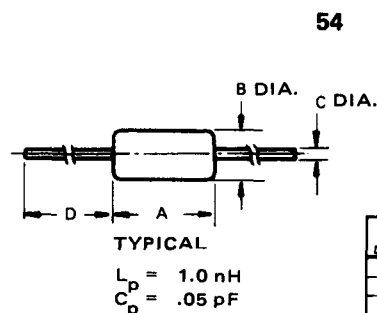

DIM.	INCHES		MM	
	MIN.	MAX.	MIN.	MAX.
A	.145	.165	3.68	4.19
B	.068	.075	1.72	1.91
C	.014	.016	0.35	0.41
D	1.000	1.500	25.4	38.1

Not to scale.

MAXIMUM RATINGS @ 25°C

Incident RF CW Power	2.0 W
Incident RF Peak Pulse Power (3 ns Max. pulse width, 1000 pps)	100mW
DC Current ⁴	10 mA

ELECTRICAL CHARACTERISTICS @ $T_A = 25^\circ\text{C}$

Model ¹ Number	Case Style	Test Freq. GHz	Min. ^{2,3}	
			Tangential Sensitivity -dBm	Video Impedance K ohms
1N833	4	9.375	45	4.5-18
1N833A	4	9.375	48	4.5-18
1N833B	4	9.375	50	4.5-18
MA-41513	54	9.375	45	4.5-18
MA-41514	54	9.375	48	4.5-18
MA-41515	54	9.375	50	4.5-18

- NOTES:
- Matched pairs are available by adding suffix M with output voltages matched to $\pm 0.5 \text{ dB}$ and $R_v \pm 10\%$ at -30 dBm .
 - Bandwidth of IF amplifier = 2 MHz, $NF_{IF} = 3.5 \text{ dB Max.}$ with an input impedance of $10,000 \Omega$. Low frequency cutoff is approximately 1.0 KHz.
 - Holder is a modified Jan-105 for 1N833 thru 1N833B and JD-2078 for MA-41513 thru MA-41515 diodes.
 - Adequate Heat Sink Required.



MICROWAVE ASSOCIATES, INC. BURLINGTON, MASSACHUSETTS

TYPICAL PERFORMANCE CURVES

1N833 VOLTAGE OUTPUT VS. INCIDENT POWER

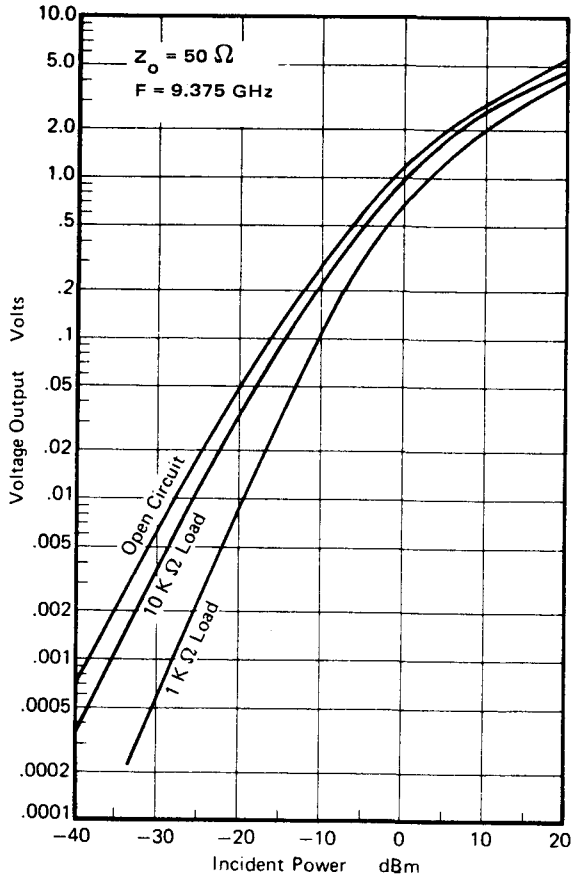

MA-41515 TYPICAL VIDEO IMPEDANCE VS. DC BIAS LEVEL

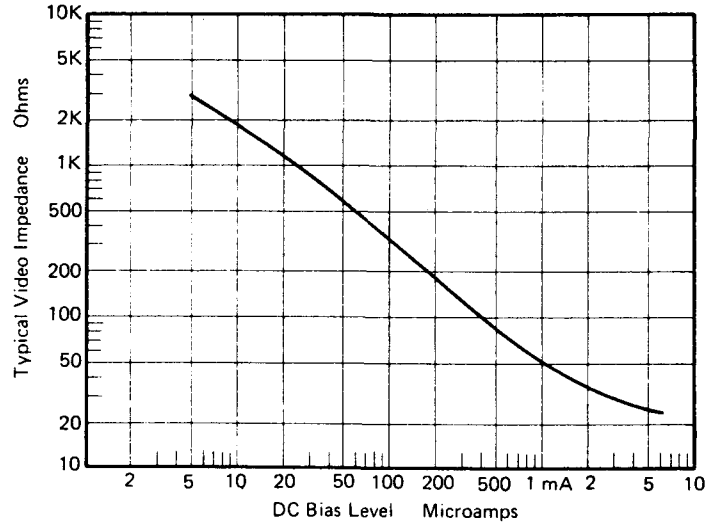

MA-41515 TSS¹ VS. DC BIAS

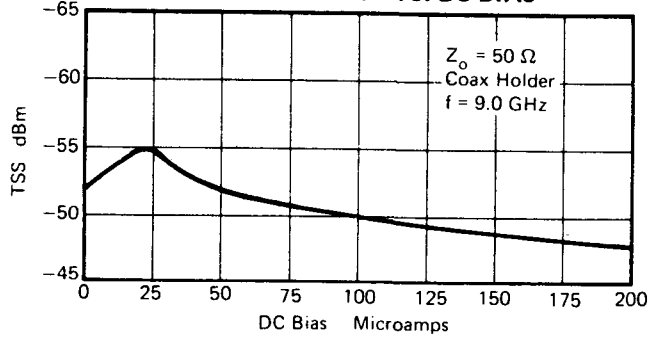

MA-41515 VOLTAGE SENSITIVITY VS. DC BIAS

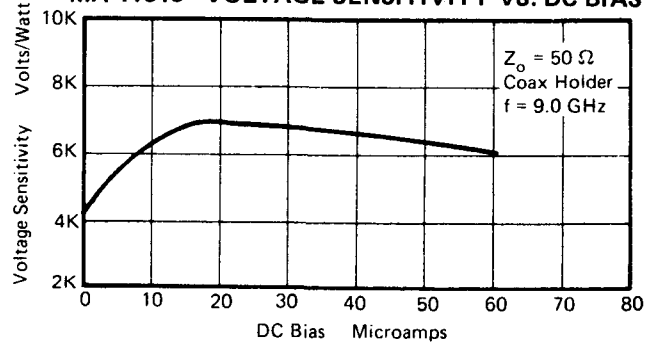

NOTE: 1. Bandwidth 2 MHz.

Point Contact Detector Diodes MQM

S-Band
X-Band
Ku-Band

CASE STYLE 100

TYPICAL
 $L_p = 2 \text{ nH}$
 $C_p = .05 \text{ pF}$

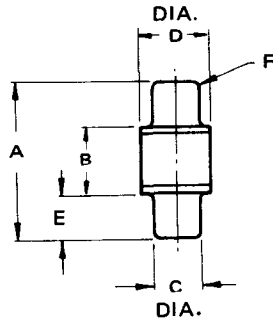

DIM.	INCHES		MM	
	MIN.	MAX.	MIN.	MAX.
A	.197	.207	5.00	5.26
B	.070	.082	1.78	2.08
C	.060	.064	1.52	1.63
D	—	.084	—	2.13
E	.062	REF.	1.57	REF.
F	—	.012	—	0.30

ENVIRONMENTAL RATINGS PER MIL-STD-750

	Method	Levels
Temperature Storage	1031	-65 to +150°C
Temperature Cycle	1051	5 Cycles -65 to +150°C
Shock	2016	500 g's
Vibration	2056	15 g's
Constant Acceleration	2006	20,000 g's
Humidity	1021	10 Days

MAXIMUM RATINGS @ 25°C (AT 25°C UNLESS OTHERWISE SPECIFIED)

Incident RF CW Power	100 mW
Incident RF Peak Pulse Power (3 ns pulse width, 1000 pps)	2.0 W
Temperature Range:	
Operating	-65 to 150°C
Storage	-65 to 150°C

ELECTRICAL CHARACTERISTICS @ $T_A = 25^\circ\text{C}$

Model Number	Frequency Band	Case Style	Test Frequency GHz	Min. TSS ¹ -dBm	Video Impedance K ohm	Min. Sensitivity mV/mW
MA-41222	S, X	100	9.375	55	1.2 - 1.8	5000
MA-41223		100	9.375	50	1.2 - 1.8	3500
MA-41224	Ku	100	16.0	52	1.2 - 1.8	3500
MA-41225		100	16.0	48	1.2 - 1.8	3000

NOTES: 1. Video bandwidth is 2 MHz. Video amplifier equivalent noise resistance is 500Ω . Input impedance is $10 \text{ K}\Omega$. DC bias is $20 \mu\text{A}$. Test holder JD 2094.



MICROWAVE ASSOCIATES, INC. BURLINGTON, MASSACHUSETTS

Point Contact Diodes for Motion Detector Applications

X-Band MA-41205
S,X-Band MA-41206
K-Band MA-41207

DESCRIPTION

This series of detector diodes is designed specifically to give maximum sensitivity in zero IF systems such as CW doppler radars, police radars, braking systems, intrusion alarms and other motion detecting systems. These diodes are specifically characterized for low noise and high voltage sensitivity in the 1-10 KHz band without degrading burnout.

CASE STYLES

3
MA-41205, X-Band

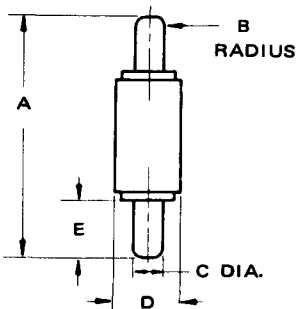

54
MA-41206 S & X Band

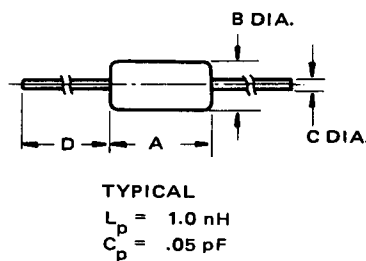

100
MA-41207, K-Band

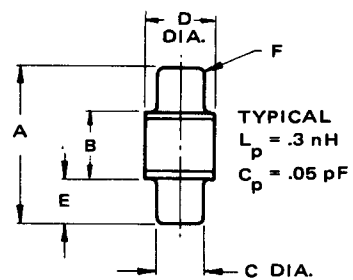

DIM.	INCHES		MM	
	MIN.	MAX.	MIN.	MAX.
A	.776	.792	19.456	20.117
B	.030	.046	0.762	1.168
C	.092	.094	2.337	2.388
D	.222	.240	5.639	6.096
E	.180	.190	4.572	4.826
F	.292	.296	7.417	7.518
G	.246	.250	6.248	6.350
H	.216	.221	5.468	5.613
J	.031	.036	0.787	0.914
K	.246	.250	6.248	6.350
L	.195	.199	4.953	5.054
M		.187		4.750
N		.100		2.540

DIM.	INCHES		MM	
	MIN.	MAX.	MIN.	MAX.
A	.145	.165	3.68	4.19
B	.068	.075	1.72	1.91
C	.014	.016	0.35	0.41
D	1.000	1.500	25.4	38.1

DIM.	INCHES		MM	
	MIN.	MAX.	MIN.	MAX.
A	.197	.207	5.00	5.26
B	.070	.082	1.78	2.08
C	.060	.064	1.52	1.63
D		.084		2.13
E	.062	REF.	1.57	REF.
F		.012		0.30

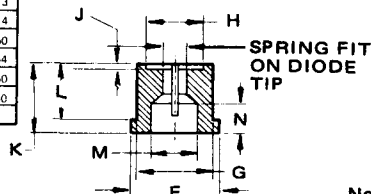

Not to scale.

MAXIMUM RATINGS @ 25°C

Incident RF CW Power	100 mW
Incident RF Peak Pulse Power (3 ns Max. pulse width, 1000 pps)	5.0 W
DC Current	5 mA

ENVIRONMENTAL RATINGS PER MIL-STD-750

	Method	Levels
Temperature, Storage	1031	-65 to +150°C
Temperature, Operating	—	-65 to +150°C
Temperature Cycling	1051	5 Cycles, -65 to +150°C
Shock	2016	500 g's
Vibration	2056	15 g's
Constant Acceleration	2006	20,000 g's
Moisture Resistance	1021	10 Days

ELECTRICAL SPECIFICATIONS @ T_A = 25°C

Test Frequency	10.525 GHz ± 250 MHz	AM Noise ²	.22 V RMS Max.	5 - 300 Hz
Conversion Loss ¹	5.0 dB, typ.		.22 mV RMS Max.	300 - 500 Hz
VSWR ¹	2.0 max.			

NOTES:

- Test Conditions: L. O. Power 1.0 mW
R_L = 600 Ohms
Holder: Modified JAN 105
F = 10.525 GHz
- For a system application, the absolute noise in terms of dB below the carrier, in a given bandwidth is of little value. Hence, using a Gunn diode source, the AM noise is specified in terms of the RMS voltage output of an
- amplifier with a voltage gain of 100,000 across the band 5Hz - 300 Hz (with a band reject filter at 120 Hz) or, as the RMS voltage output of an amplifier with a voltage gain of 1000 across the band 300 Hz - 5000 Hz. .5 mW of RF power is incident on the detector and sensitivity is approximate 800 mV/mW.
- European motion detection frequencies are 9.4 GHz, 9.8 GHz, 10.55 GHz, and 10.8 GHz. The MA-41205 and MA-41206 are designed for this band and are chosen on the basis of package style required.

MICROWAVE ASSOCIATES, INC. BURLINGTON, MASSACHUSETTS

Additional Point Contact Detector Diodes

UHF - Ku-Band

ELECTRICAL CHARACTERISTICS @ $T_A = 25^\circ\text{C}$

Type Number	Case Style	Test Freq. GHz	Min. TSS -dBm	Min. FM	Video Impedance K Ohm		Comment	
					Min.	Max.		
1N830	4	0.1	—	—	—	—	Rectification efficiency 65%	
JAN 1N830A	4	0.1	—	—	—	—		
MA-4140	4	0.1	—	—	—	—		
MA-4815	57	0.1	—	—	—	—		
MA-4815A	57	0.1	—	—	—	—		
1N32	7-1	3.295	49	85	4	22		
JAN 1N32	7-1	3.295	49	85	4	22		
MA-4139	4	3.06	50	100	5	25		
MA-4142	3	3.06	50	100	5	25		
MA-4142A	3	3.06	52	200	5	25		
MA-417	3	3.295	49	85	4	22		
1N2102	3	3.295	—	85	4	22		
1N4379	4	3.295	50	100	5	25		
MA-408	7-1	9.00	50	130	1.7	3.1		dc bias 50 μ A
1N1611	7-1	9.00	50	130	1.7	3.1		dc bias 50 μ A
MA-418	3	9.00	50	130	1.7	3.1	dc bias 50 μ A	
MA-461	3	9.00	50	130	1.7	3.1	dc bias 50 μ A	
MA-4129	3	9.00	50	130	1.7	3.1	dc bias 50 μ A	
MA-418A	3	9.00	50	160	1.7	3.1	dc bias 50 μ A	
MA-452	7-1	9.00	50	130	1.7	3.1	dc bias 50 μ A	
MA-4128	7-1	9.00	50	130	1.7	3.1	dc bias 50 μ A	
MA-408A	7-1	9.00	51	160	1.7	3.1	dc bias 50 μ A	
1N1611A	7-1	9.00	51	160	1.7	3.1	dc bias 50 μ A	
MA-452A	7-1	9.00	51	160	1.7	3.1	dc bias 50 μ A	
MA-461A	3	9.00	51	160	1.7	3.1	dc bias 50 μ A	
MA-418B	3	9.00	52	220	1.7	3.1	dc bias 50 μ A	
MA-461B	3	9.00	52	220	1.7	3.1	dc bias 50 μ A	
MA-408B	7-1	9.00	52	220	1.7	3.1	dc bias 50 μ A	
1N1611B	7-1	9.00	52	220	1.7	3.1		
MA-452B	7-1	9.00	52	220	1.7	3.1		
MA-4116	11	16.0	52	200	1.6	2.4		



MICROWAVE ASSOCIATES, INC. BURLINGTON, MASSACHUSETTS

SELECTION GUIDE-SILICON SCHOTTKY DETECTOR DIODES IN HERMETIC PACKAGES

Test Frequency Case Style TSS' -dBm	3.0 GHz			10 GHz								
	Ceramic 3	Glass 54	MQM Glass 100	Ceramic 3	Glass 54	MQM Glass 100	MQM Ceramic 119	Pill 120	Stripline 186	MQM Ceramic 119	Pill 120	Stripline 186
55	MA-40041	MA-40053	MA-40025		MA-40202		MA-40201	MA-40207	MA-40225	MA-40251	MA-40257	MA-40209
52				MA-40043	MA-40204	MA-40027	MA-40203	MA-40208	MA-40226	MA-40253	MA-40258	MA-40210
50	MA-40040	MA-40052	MA-40024	MA-40042		MA-40026						
Comment	Waveguide detectors	Broadband	General purpose	Waveguide detector, Low 1/F noise	General purpose	Better bandwidth than 119	Bonded diode	Bonded pill, Broad bandwidth	Broadband	p type		

Test Frequency Case Style TSS' -dBm	10 GHz (cont.)			16 GHz						34 GHz		
	MQM Ceramic 119	Pill 120	Stripline 186	MQM Glass 100	MQM Ceramic 119	Pill 120	MQM Ceramic 119	Pill 120	MQM Ceramic 119	Pill 120	MQM Ceramic 119	Pill 120
56	MA-40232	MA-40230	MA-40228									
52	MA-40233	MA-40231	MA-40227	MA-40029	MA-40205	MA-40215	MA-40255	MA-40265	MA-40242	MA-40240		
50					MA-40206	MA-40216	MA-40256	MA-40266	MA-40244	MA-40241		
48				MA-40028							MA-40249	MA-40248
Comment	Zero Bias			Better bandwidth than 119	Bonded diode, Better burnout than 100	Bonded pill, Broad bandwidth	p type			zero bias	zero bias	

NOTE:

1. Video Bandwidth = 2 MHz.



MICROWAVE ASSOCIATES, INC. BURLINGTON, MASSACHUSETTS

SELECTION GUIDE-SILICON SCHOTTKY DETECTOR DIODES FOR STRIPLINE AND HYBRID INTEGRATED CIRCUITS

Case Style Frequency	134 Chip	137 Stripline	81 Lid	135 Chip	185 Beamlead	Note
L-Band	MA-40192					
S-Band	MA-40193					
C-Band		MA-40036				
X-Band		MA-40037 MA-40038 MA-40229	MA-40221 MA-40271 MA-40239	MA-40220 MA-40270 MA-40237	MA-40223	n-type p-type Zero Bias
Ku-Band				MA-40222 MA-40272 MA-40243	MA-40175	n-type p-type Zero Bias



MICROWAVE ASSOCIATES, INC. BURLINGTON, MASSACHUSETTS

Schottky Barrier Diodes For Detector Applications

Bulletin 4250

Zero Bias Detector Diodes

n-type Detector Diodes

p-type Detector Diodes

Beam Lead Diodes

Doppler Diodes

FEATURES:

ZERO BIAS SCHOTTKY DETECTOR DIODES

- Ultra low $1/f$ noise
- High sensitivity at zero bias
- High resistance to burnout

N-TYPE SCHOTTKY DETECTOR DIODES

- Low $1/f$ noise
- High Sensitivity (TSS) at low bias ($20 \mu\text{A}$)

P-TYPE SCHOTTKY DETECTOR DIODES

- Low $1/f$ noise
- High Sensitivity (TSS) at low bias ($20 \mu\text{A}$)
- High Output Voltage Sensitivity
- Opposite output voltage polarity to n-type diodes for specific applications.

Zero Bias Schottky Detector Diodes

*L through X-Band, MA-40230 Series
Ku and Ka-Band, MA-40240 Series*

DESCRIPTION

The MA-40230 and MA-40240 Series of diodes were designed for detector applications where high sensitivity is required, without the use of external bias supplies. These devices are oxide passivated Schottky barrier diodes and are available both in standard packages and in case styles suitable for use in hybrid-integrated circuits.

MAXIMUM RATINGS @ 25°C

Incident RF CW Power	100 mW
Incident RF Peak Pulse Power (3 ns Max. pulse width, 1000 pps)	2.0 W
DC Forward Current	30 mA
Temperature:	
Operating	-65 to +150°C
Storage	-65 to +150°C

ENVIRONMENTAL RATINGS PER

MIL-STD-750

	Method	Level
Temperature Storage	1031	-65 to +150°C
Temperature Cycle	1051	5 Cycles -65 to +150°C
Shock	2016	500 g's
Vibration	2056	15 g's
Constant Acceleration	2006	20,000 g's
Humidity	1021	10 Days

ELECTRICAL CHARACTERISTICS @ T_A = 25°C

Frequency Band	Model Number	Case ¹ Style	Test Frequency GHz	Min. ² Tangential Sensitivity -dBm	Video Resistance K ohm	Min. ³ Sensitivity mV/mW
L - through - X	MA-40230	120	10.0	55	3.0 - 7.0	8000
	MA-40231	120	10.0	52	2.0 - 8.0	4000
	MA-40232	119	10.0	55	3.0 - 7.0	8000
	MA-40233	119	10.0	52	2.0 - 8.0	4000
	MA-40234	54	10.0	55	3.0 - 7.0	8000
	MA-40235	54	10.0	52	2.0 - 8.0	4000
	MA-40236	121	-	55 typ.	5.0 typ.	8000 typ.
	MA-40237	135	-	55 typ.	5.0 typ.	8000 typ.
Ku	MA-40240	120	16.0	52	4.0 - 8.0	6000
	MA-40241	120	16.0	49	3.0 - 4.0	3000
	MA-40242	119	16.0	52	4.0 - 8.0	6000
	MA-40243	135	-	52 typ.	6.0 typ.	6000 typ.
	MA-40244	119	16.0	49	3.0 - 9.0	3000
Ka	MA-40248	119	34	49	4.0 - 10.0	4000
	MA-40249	120	34	49	4.0 - 10.0	4000

NOTES:

- Case Styles 119, 120 and 121 incorporate thermo-compression bonds. Maximum solder temperature for all case styles is 230°C for 5 seconds.
- Test Condition: Video bandwidth - 2 MHz; video amplifier noise resistance - 500Ω; Input impedance - 10 KΩ; no bias.
- Test Condition: RF signal power = -40 dBm.



MICROWAVE ASSOCIATES, INC. BURLINGTON, MASSACHUSETTS

TYPICAL PERFORMANCE CURVES

FIGURE 1 TYPICAL I - V CHARACTERISTICS ZERO BIAS SCHOTTKY DIODES

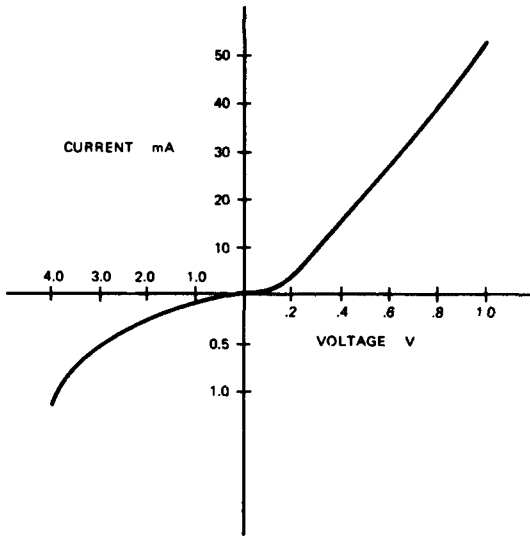

FIGURE 2 TYPICAL VOLTAGE OUTPUT VS. RF POWER FOR MA-40230 SERIES

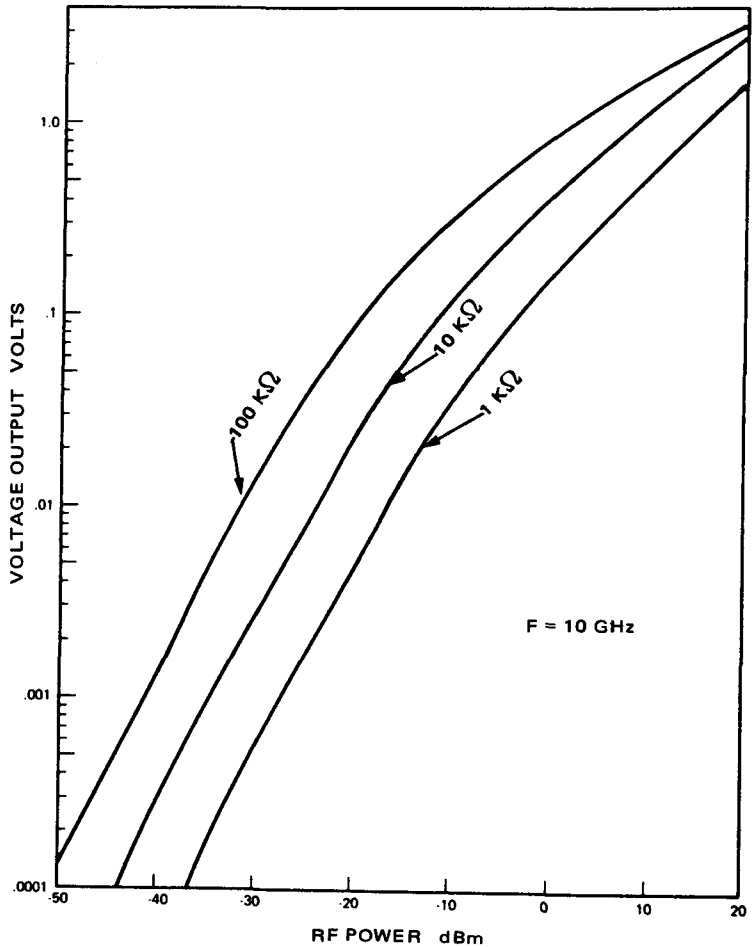

FIGURE 3 TYPICAL TSS VS. FREQUENCY MA-40230 SERIES

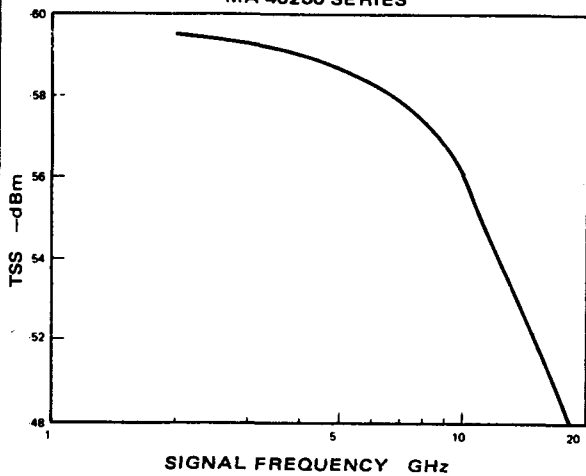
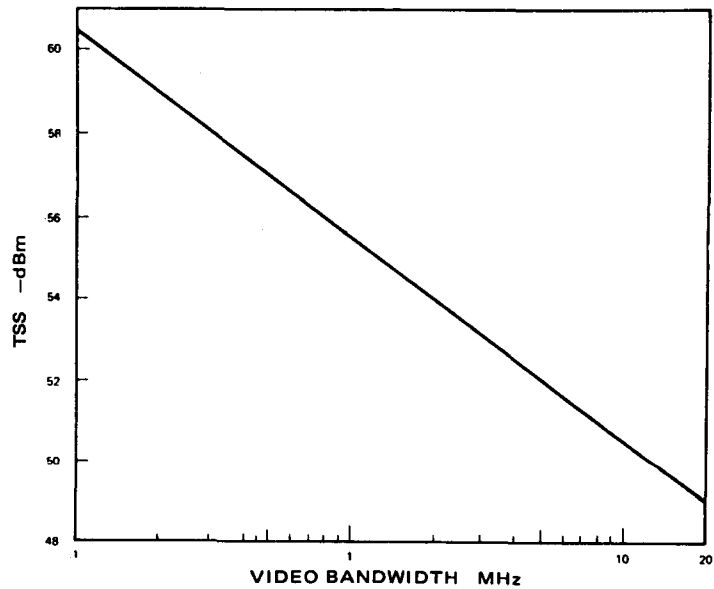

FIGURE 4 TSS (CALCULATED) VS. VIDEO BANDWIDTH



N-Type Schottky Detector Diodes

L through Ku-Band MA-40200 Series

DESCRIPTION

The MA-40200 series of thermo-compression bonded oxide passivated Schottky barrier detector diodes is offered in hermetically sealed packages. Other case styles suitable for use in hybrid integrated circuits are available. This series features highly sensitive, low barrier and bondable Schottky junctions.

MAXIMUM RATINGS @ 25°C

Incident RF CW Power	100 mW
Incident RF Peak Pulse Power (3 ns Max. pulse width, 1000 pps)	2.0 W
DC Forward Current	30 mA
Temperature:	
Operating	-65 to +150°C
Storage	-65 to +150°C

ENVIRONMENTAL RATINGS

PER MIL - STD - 750

	Method	Level
Temperature Storage	1031	-65 to +150°C
Temperature Cycle	1051	5 Cycles -65 to +150°C
Shock	2016	500 g's
Vibration	2056	15 g's
Constant Acceleration	2006	20,000 g's
Humidity	1021	10 Days

ELECTRICAL CHARACTERISTICS @ T_A = 25°C Schottky Barrier Detector Diodes¹

Frequency Band	Model Number	Case ^{1, 2} Style	Test Frequency GHz	Min. ^{3, 4} Tangential Sensitivity -dBm	Video ⁴ Impedance K ohm	Min. ⁴ Sensitivity mV/mW
L - through - X	MA-40201	119	9.3	55	1.2-1.8	5000
	MA-40203	119	9.3	52	1.2-1.8	3500
	MA-40202	54	9.3	55	1.2-1.8	5000
	MA-40204	54	9.3	52	1.2-1.8	3500
	MA-40207	120	9.3	55	1.2-1.8	5000
	MA-40208	120	9.3	52	1.2-1.8	3500
Ku	MA-40205	119	16.0	52	1.2-1.8	3500
	MA-40206	119	16.0	50	1.2-1.8	3000
	MA-40215	120	16.0	52	1.2-1.8	3500
	MA-40216	120	16.0	50	1.2-1.8	3000

Schottky Barrier Detector Diode Chips for Hybrid Circuits¹

Model Number	Chip Style	Min. ⁵ Breakdown Voltage Volts	Max. ⁶ Zero Voltage Capacitance pF	Typ. Forward Voltage Volts	Typ. Tangential Sensitivity -dBm
X-Band					
MA-40220	135	2	.12	.3	55
MA-40221	121	2	.22	.3	55
Ku-Band					
MA-40222	135	2	.09	.3	52

NOTES:

- Schottky Barrier junctions thermo-compression bonded in Case Styles 119, 120, 121.
- Max. solder temperature for all Case Styles except 120 is 230°C for 5 seconds.
- Video bandwidth is 2 MHz. Video amplifier equivalent noise resistance is 500 Ω. Input impedance is 10 K Ω.
- DC Bias is 20 μA.
- Breakdown voltage @ -10 μA.
- Capacitance measured at 1.0 MHz.
- Forward voltage is measured at 1 mA.



MICROWAVE ASSOCIATES, INC. BURLINGTON, MASSACHUSETTS

TYPICAL PARAMETER VALUES

Case Styles	54	119	120	121	135
Package Capacitance — C_p	.05 pF	.15 pF	.13 pF	0.2 pF	—
Package Inductance — L_p	1 nH	.5 nH	.4 nH	—	—
Series Resistance — R_s	25 Ω	25 Ω	25 Ω	25 Ω	25 Ω
Junction Capacitance — C_j	.07 pF	.07 pF	.07 pF	.07 pF	.07 pF

CASE STYLES

54

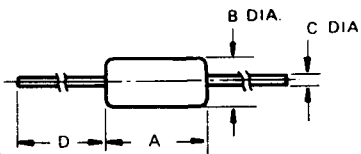

DIM.	INCHES		MM	
	MIN.	MAX.	MIN.	MAX.
A	.145	.165	3.68	4.19
B	.068	.075	1.72	1.91
C	.014	.016	0.35	0.41
D	1.000	1.500	25.4	38.1

119

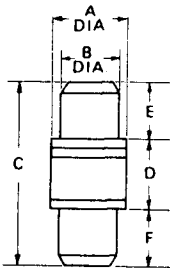

DIM.	INCHES		MM	
	MIN.	MAX.	MIN.	MAX.
A	.078	.086	2.01	2.11
B	.060	.064	1.52	1.63
C	.190	.210	4.85	5.33
D	.070	.082	1.68	2.08
E	.060	.064	1.52	1.63
F	.060	.064	1.52	1.63

121

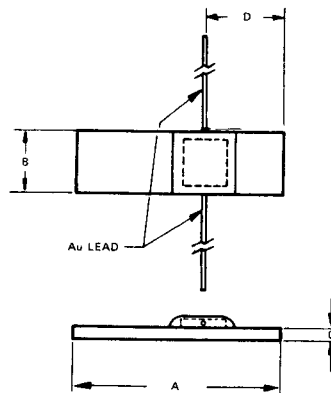

DIM.	INCHES		MM	
	MIN.	MAX.	MIN.	MAX.
A	.063	.067	1.60	1.70
B	.019	.021	0.48	0.53
C	.004	.006	0.10	0.15
D	NOM.	.025	NOM.	0.64

120

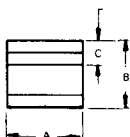

DIM.	INCHES		MM	
	MIN.	MAX.	MIN.	MAX.
A	.051	.055	1.29	1.40
B	.040	.050	1.02	1.27
C	—	.015	—	0.38

135

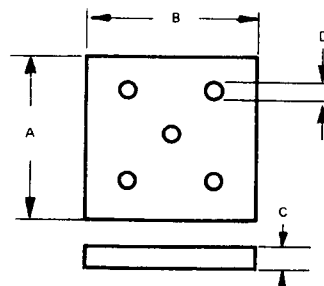

DIM.	INCHES		MM	
	MIN.	MAX.	MIN.	MAX.
A	.13	.17	3.30	4.31
B	.13	.17	3.30	4.31
C	.04	.06	1.01	1.42
D	.001	—	0.02	—

Not to scale.

TYPICAL PERFORMANCE CURVES

TYPICAL VOLTAGE OUTPUT VS. RF POWER FOR MA-40200 SERIES
(20 μ A FORWARD BIAS)

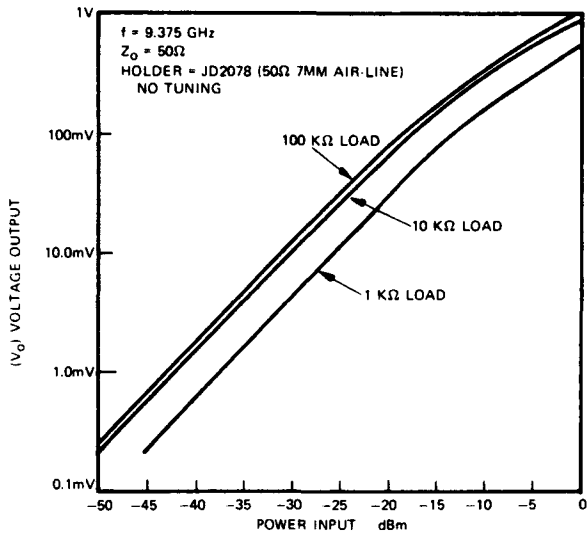

TYPICAL VOLTAGE OUTPUT VS. RF POWER (NO BIAS) FOR MA-40200 SERIES

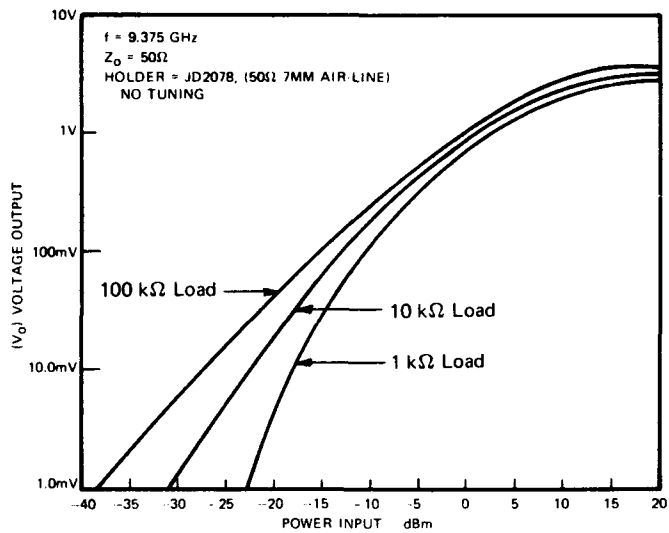

TSS VS. FREQUENCY
FOR MA-40200 SERIES

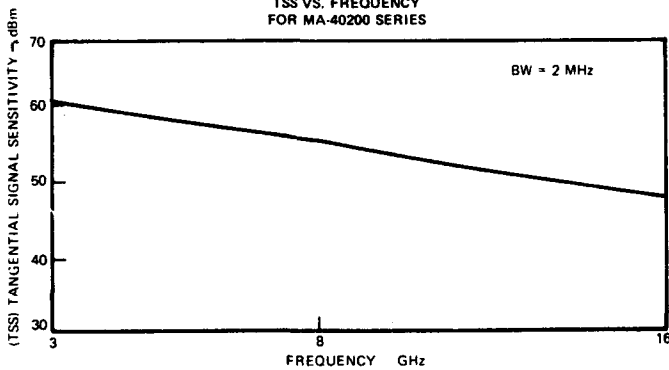

TYPICAL VIDEO IMPEDANCE VS. FORWARD DC BIAS
FOR MA-40200 SERIES

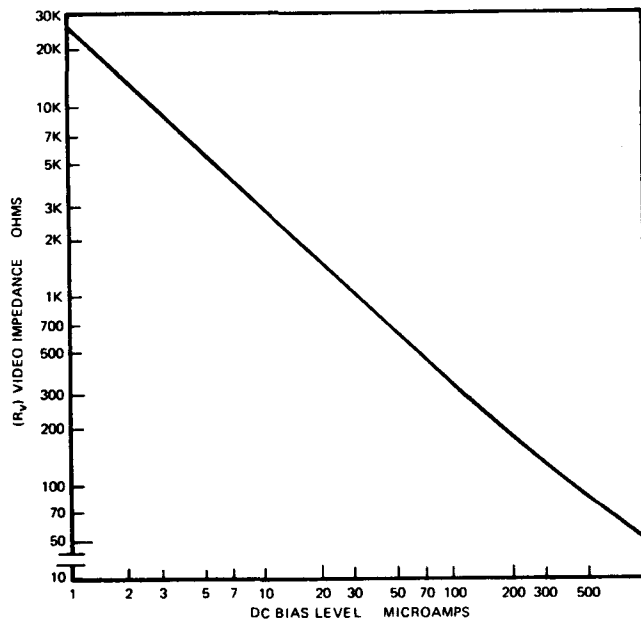

TYPICAL TSS VS. DC BIAS LEVEL
FOR MA-40200 SERIES

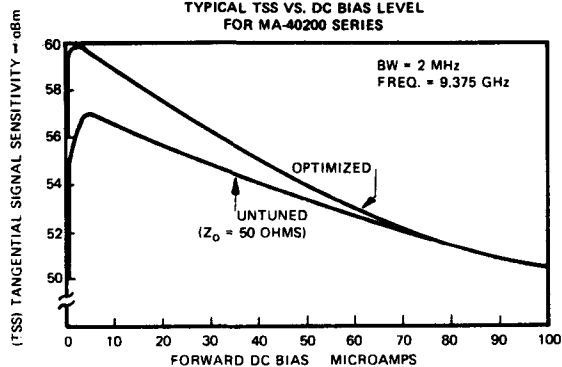

Additional N-Type Schottky Detector Diodes

S through Ku-Band

DESCRIPTION

This series of Schottky barrier diodes is offered in a hermetically sealed glass, ceramic, and Kovar glass package and designed for use in applications where noise figure and high reliability are important criteria. Each device is RF characterized for use within a specific frequency band. All diodes in this series offer wide dynamic range, and improved reliability.

MAXIMUM RATINGS

(@ 25°C, unless otherwise specified)

Incident RF CW Power

S-Band	150 mW
X-Band	100 mW
Ku-Band	60 mW

Reverse Voltage 3 Volts, Min.

Temperature:

Operating	-65 to +150°C
Storage	-65 to +175°C

ENVIRONMENTAL RATINGS PER MIL-STD-750

	Method	Levels
Temperature Storage	1031	See Max. Ratings
Temperature Operating	—	See Max. Ratings
Temperature Cycling	1051	5 Cycles, -65 to +150°C
Shock	2016	500 g's
Vibration	2056	20 g's
Constant Acceleration	2006	20,000 g's
Humidity	1021	10 Days

ELECTRICAL CHARACTERISTICS @ T_A = 25°C

Frequency Band	Model Number	Case Style	Test Frequency GHz	Min. ^{1, 2} Tangential Sensitivity -dBm	Video ¹ Impedance K ohm
S	MA-40053	54	3.0	55	1 - 2
	MA-40052	54	3.0	50	1 - 2
X	MA-40073	54	10.0	52	1 - 2
	MA-40072	54	10.0	50	1 - 2
S	MA-40025	100	3.0	55	1 - 2
	MA-40024	100	3.0	50	1 - 2
X	MA-40027	100	10.0	52	1 - 2
	MA-40026	100	10.0	50	1 - 2
Ku	MA-40029	100	16.0	52	1 - 2
	MA-40028	100	16.0	48	1 - 2
S	MA-40040	3	3.0	50	1 - 2
	MA-40041	3	3.0	55	1 - 2
X	MA-40042	3	10.0	50	1 - 2
	MA-40043	3	10.0	52	1 - 2

NOTE:

1. Bias = 30 μA
2. Video bandwidth is 2 MHz. Video amplifier equivalent noise resistance is 500Ω. Input impedance is 10 KΩ.

TYPICAL PERFORMANCE CURVES

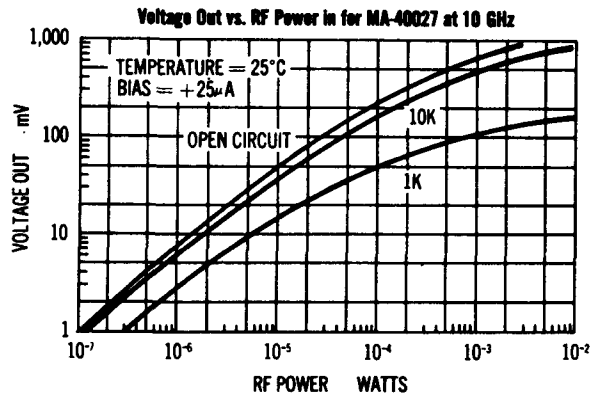
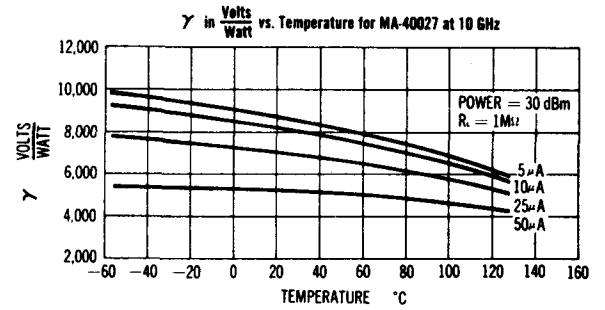
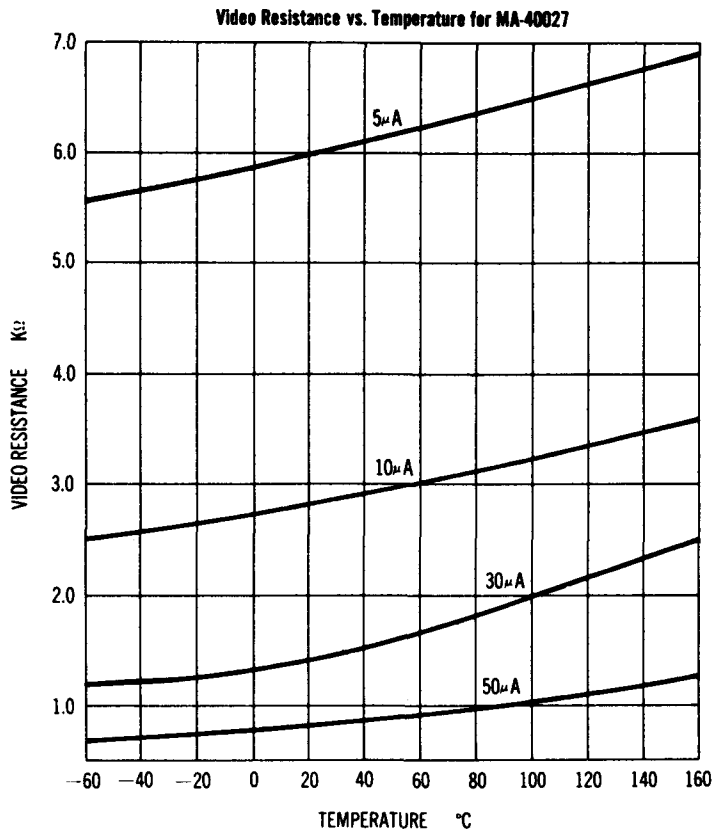

Typical RF Impedance of MA-40027 in Holder JD-2097
(Power = -30 dBm) Referenced to 50 + j0 ohms

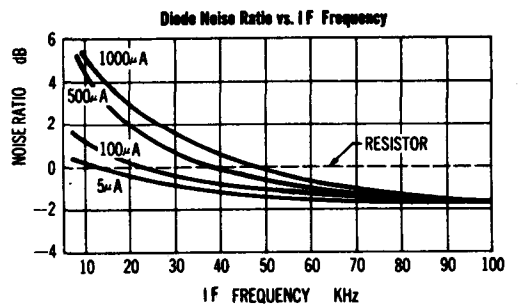
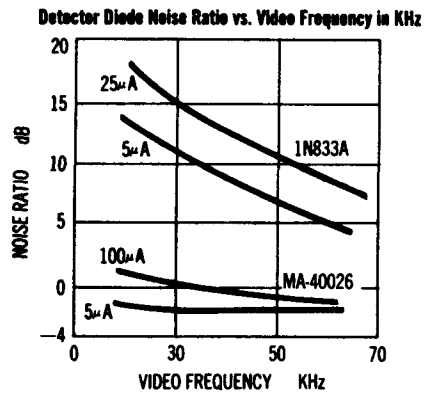
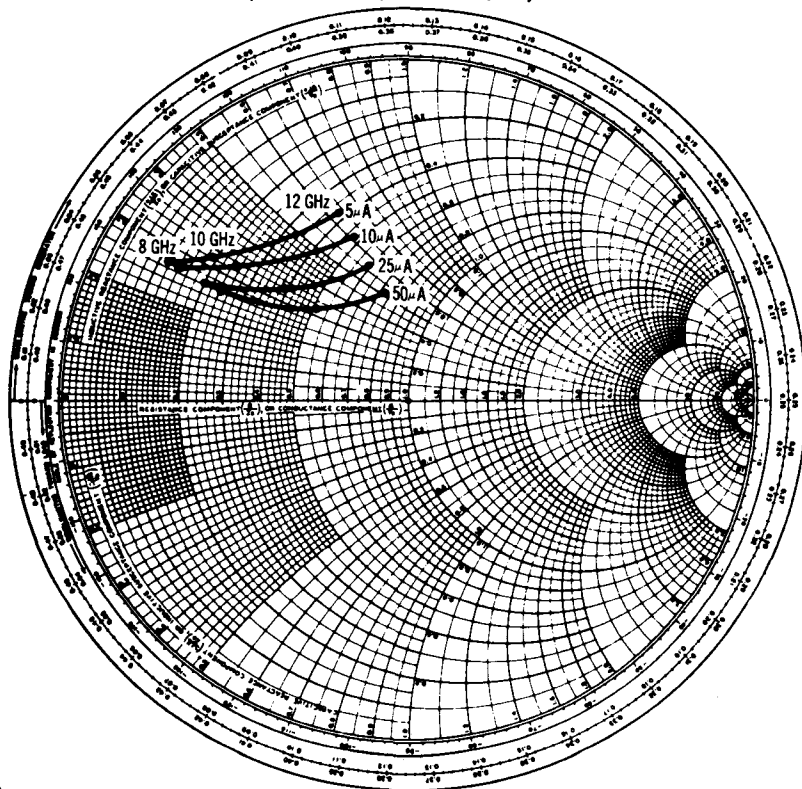

P-Type Schottky Detector Diodes

L through X-Band, MA-40251 Series
Ku-Band, MA-40255 Series
Ka-Band, MA-40267 Series

DESCRIPTION

The MA-40250 series of thermo-compression bonded oxide passivated Schottky barrier detector diodes is offered in hermetically sealed packages. Other case styles suitable for use in hybrid integrated circuits are available. These p-type devices feature high sensitivity, low barrier height and low 1/F noise Schottky junctions. (P-type Schottky diodes generally exhibit lower 1/F noise than N-type diodes.)

MAXIMUM RATINGS @ 25°C

Incident RF CW Power	100 mW
Incident RF Peak Pulse Power (3 ns Max. pulse width, 1000 pps)	2.0 W
DC Forward Current	20 mA
Temperature:	
Operating	-65 to +150°C
Storage	-65 to +150°C

ENVIRONMENTAL RATINGS PER MIL-STD-750

	Method	Level
Temperature Storage	1031	-65 to +150°C
Temperature Cycle	1051	10 Cycles -65 to +150°C
Shock	2016	500 g's
Vibration	2056	15 g's
Constant Acceleration	2006	20,000 g's
Humidity	1021	10 Days

ELECTRICAL CHARACTERISTICS @ T_A = 25°C

Schottky Barrier Detector Diodes¹

Frequency Band	Model Number	Case ² Style	Test Frequency GHz	Min. ³ Tangential Sensitivity -dBm	Video ⁴ Impedance K ohm	Min. ⁴ Sensitivity mV/mW
L - through - X	MA-40251	119	9.3	55	1.2-1.8	5,000
	MA-40253	119	9.3	52	1.2-1.8	3,500
	MA-40252	54	9.3	55	1.2-1.8	5,000
	MA-40254	54	9.3	52	1.2-1.8	3,500
	MA-40257	120	9.3	55	1.2-1.8	5,000
	MA-40258	120	9.3	52	1.2-1.8	3,500
Ku	MA-40255	119	16.0	52	1.2-1.8	3,500
	MA-40256	119	16.0	50	1.2-1.8	3,000
	MA-40265	120	16.0	52	1.2-1.8	3,500
	MA-40266	120	16.0	50	1.2-1.8	3,000
Ka	MA-40267	119	36.0	49	1.0-2.0	3,000
	MA-40268	120	36.0	49	1.0-2.0	3,000

Schottky Barrier Detector Diode Chips for Hybrid Circuits

Frequency Band	Model Number	Case Style	Min. ⁵ Breakdown Voltage Volts	Max. ⁶ Zero Voltage Capacitance pF	Typ. ⁷ Forward Voltage Volts	Typ. Tangential Sensitivity -dBm
X	MA-40270	135	4	.11	.4	55
	MA-40271	121	4	.22	.4	55
	MA-40273	185	4	.20	.4	55



MICROWAVE ASSOCIATES, INC. BURLINGTON, MASSACHUSETTS

Frequency Band	Model Number	Case Style	Min. ⁵ Breakdown Voltage Volts	Max. ⁶ Zero Voltage Capacitance pF	Typ. ⁷ Forward Voltage Volts	Typ. Tangential Sensitivity -dBm
Ku	MA-40272	135	4	.08	.4	52
	MA-40274	185	4	.15	.4	52

- NOTES:**
- Schottky Barrier junctions thermo-compression bonded in Case Styles 119, 120, 121.
 - Max. solder temperature for all Case Styles except 120 is 230°C for 5 seconds. For Case Style 120, max. solder temperature is 200°C for 5 seconds.
 - Video bandwidth is 2 MHz. Video amplifier equivalent noise resistance is 500 Ω. Input impedance is 10KΩ. DC Bias is 20μA.
 - P_{RF} = -40 dBm; DC Bias: 20 μA
 - Breakdown voltage is measured at - 10 μA.
 - Capacitance is measured at 1 MHz.
 - Forward voltage is measured at + 1 mA.

TYPICAL PARAMETER VALUES

Case Styles	54	119	120	121	135	185
Package Capacitance - C _p	.05 pF	.15 pF	.13 pF	0.2 pF	—	—
Package Inductance - L _p	1 nH	.5 nH	.4 nH	—	—	—
Series Resistance - R _s	25Ω	25Ω	25Ω	25 Ω	25Ω	25Ω
Junction Capacitance - C _j	.08 pF	.08 pF	.08 pF	.08 pF	.08 pF	.08 pF

CASE STYLES

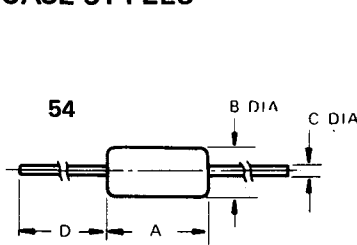

DIM.	INCHES		MM	
	MIN.	MAX.	MIN.	MAX.
A	.145	.165	3.68	4.19
B	.068	.075	1.72	1.91
C	.014	.016	0.35	0.41
D	1.000	1.500	25.4	38.1

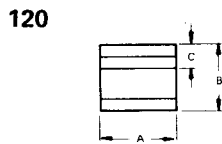

DIM.	INCHES		MM	
	MIN.	MAX.	MIN.	MAX.
A	.051	.055	1.29	1.40
B	.040	.050	1.02	1.27
C	.015	—	0.38	—

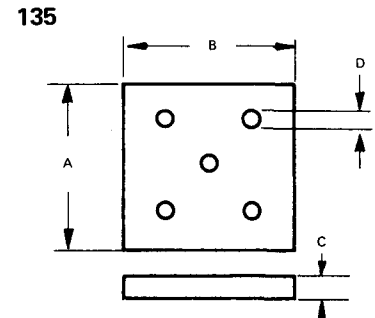

DIM.	INCHES		MM	
	MIN.	MAX.	MIN.	MAX.
A	.13	.17	3.30	4.31
B	.13	.17	3.30	4.31
C	.04	.06	1.01	1.42
D	.001	—	0.02	—

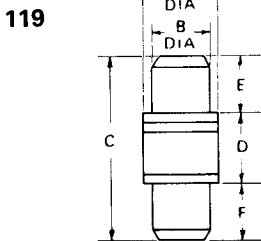

DIM.	INCHES		MM	
	MIN.	MAX.	MIN.	MAX.
A	0.78	0.86	2.01	2.11
B	0.60	0.64	1.52	1.63
C	1.90	2.10	4.85	5.33
D	0.70	0.82	1.68	2.08
E	0.60	0.64	1.52	1.63
F	0.60	0.64	1.52	1.63

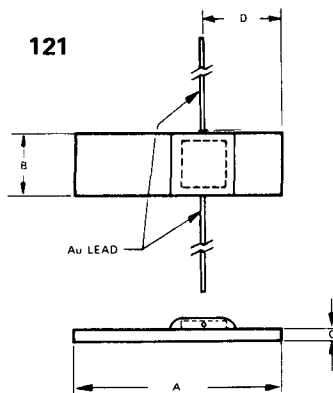

DIM.	INCHES		MM	
	MIN.	MAX.	MIN.	MAX.
A	.063	.067	1.60	1.70
B	.019	.021	0.48	0.53
C	.004	.006	0.10	0.15
D	NOM	.025	NOM	0.64

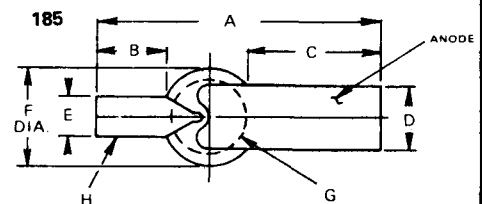

DIM.	INCHES		MM	
	MIN.	MAX.	MIN.	MAX.
A	.036	.038	0.91	0.97
B	.009	—	0.23	—
C	.016	—	0.41	—
D	.007	.009	0.18	0.23
E	.004	.006	0.10	0.15
F	—	.015	—	0.38
G	.003	.005	0.08	0.13
H	.0003	.0005	0.008	0.013

Not to scale.

TYPICAL PERFORMANCE CURVES

TYPICAL VOLTAGE OUTPUT VS. RF POWER FOR MA 40250 SERIES
(20 μ A FORWARD BIAS)

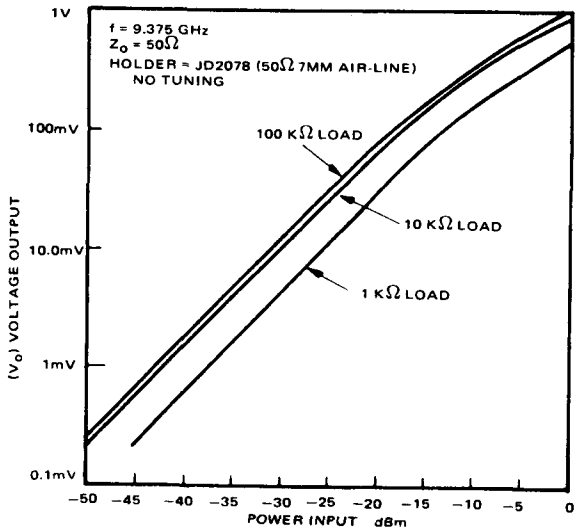

TYPICAL VOLTAGE OUTPUT VS. RF POWER (NO BIAS) FOR MA 40250 SERIES

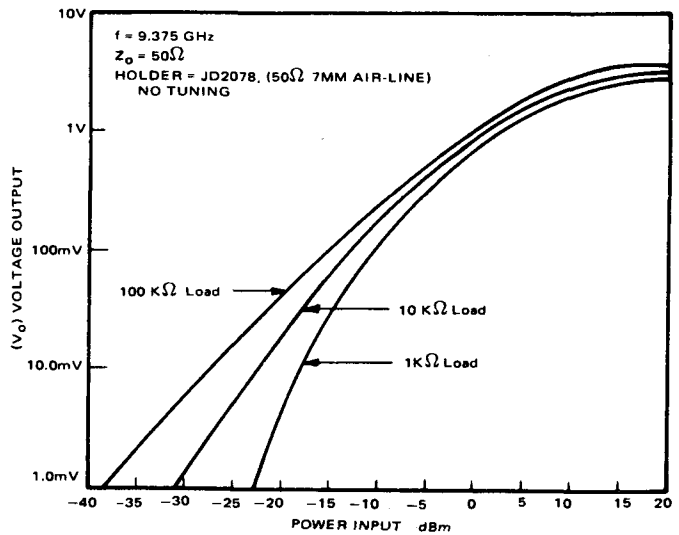

TSS VS. FREQUENCY
FOR MA 40250 SERIES

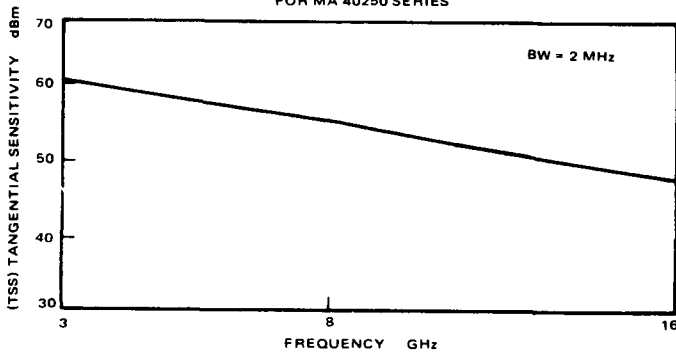

TYPICAL VIDEO IMPEDANCE VS. FORWARD DC BIAS
FOR MA 40250 SERIES

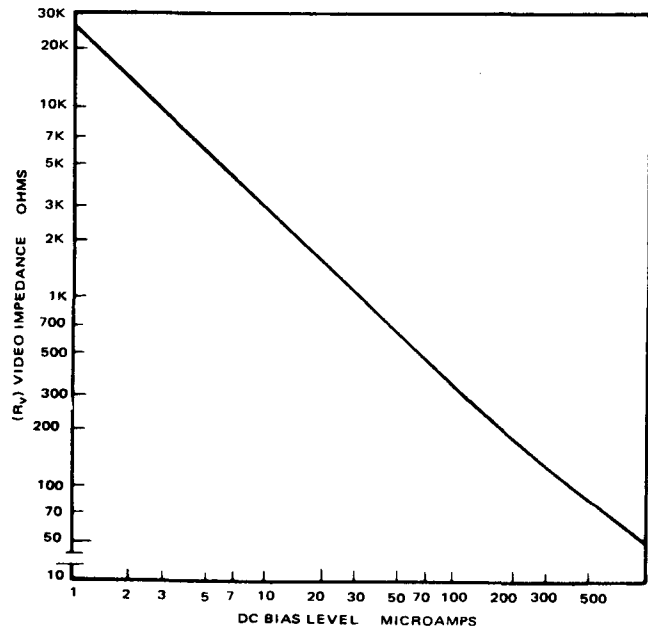

TYPICAL TSS VS. DC BIAS LEVEL
FOR MA 40250 SERIES

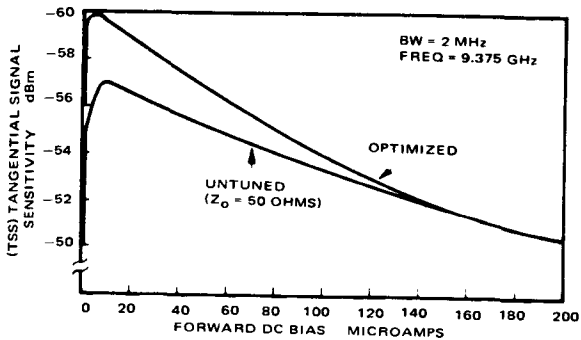

Beam Lead Schottky Detector Diodes

Ku-Band MA-40175

CASE STYLE 185

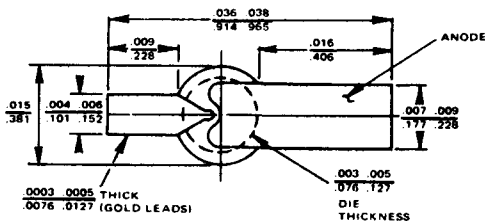

KEY

INCH
MM

MAXIMUM RATINGS @ 25°C

Incident RF CW Power	100 mW
Incident RF Peak Pulse Power (3 ns Max. pulse width, 1000 pps)	2W
Operating Temperature Range	-60°C to +150°C
Storage Temperature Range	-60°C to +150°C
Maximum Pull On Any Lead	2 grams
Diode Mounting Temperature	220°C for 10 sec. max.

ELECTRICAL CHARACTERISTICS @ T_A = 25°C

Diode	Parameter	Symbol	Typical Value	Units	Test Conditions
MA-40175	Tangential Sensitivity	TSS	55	-dBm	25 μ A Bias
Ku-Band	Detection Sensitivity	γ	7000	mV/mW	Video Bandwidth 2 MHz
Detector	Video Impedance	R _V	1400	Ohms	f = 9.375 GHz

TYPICAL PERFORMANCE CURVES

Figure 1. Typical Forward Characteristics Low Barrier Diodes

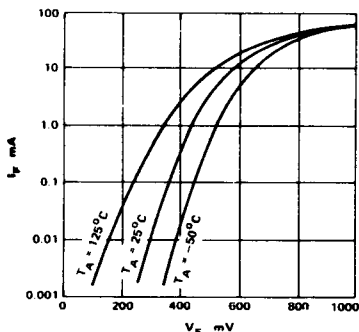
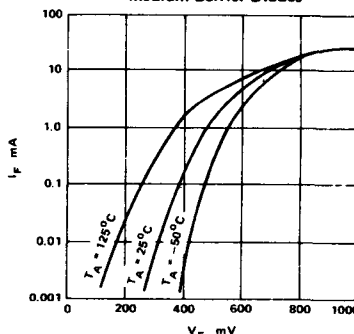

Figure 2. Typical Forward Characteristics Medium Barrier Diodes



MICROWAVE ASSOCIATES, INC. BURLINGTON, MASSACHUSETTS

Low Noise Schottky Detector for Zero IF Systems

MA-40074

CASE STYLE

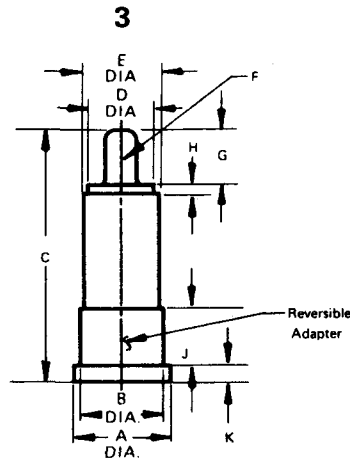

DIM.	INCHES		MM	
	MIN.	MAX.	MIN.	MAX.
A	0.292	0.296	7.417	7.618
B	0.246	0.250	6.248	6.350
C	0.753	0.783	19.13	19.89
D	0.195	0.225	4.953	5.715
E	—	0.240	—	6.096
F	0.030	0.046	0.766	1.168
G	0.092	0.094	2.336	2.387
H	—	0.030	—	0.762
J	0.193	0.199	4.902	5.054
K	0.047	0.057	1.194	1.448

MAXIMUM RATINGS @ 25°C

Incident RF CW Power	200 mW
Incident RF Peak Pulse Power (3 ns Max. pulse width, 1000 pps)	5.0 W
DC Current	15 mA

ENVIRONMENTAL RATINGS PER MIL-STD-750

	Method	Levels
Temperature, Storage	1031	-65 to +150°C
Temperature, Operating	—	-65 to +150°C
Temperature Cycling	1051	5 Cycles, -65 to +150°C
Shock	2016	500 g's
Vibration	2056	15 g's
Constant Acceleration	2006	20,000 g's
Moisture Resistance	1021	10 Days

ELECTRICAL SPECIFICATIONS @ T_A = 25°C

Frequency Range	10.525 GHz ± 250 MHz
Conversion Loss ¹	5.0 dB Typ.
VSWR ¹	2.0:1 Max.
AM Noise ²	.22 V RMS Max. 5 - 300 Hz .22 mV RMS Max. 300 - 5000 Hz

NOTES:

- Test Conditions: L.O. Power 1.0 mW
R_L = 100 ohms
Holder-modified JAN 105
F = 10.525 GHz
- For a system application, the absolute noise in terms of dB below the carrier, in a given bandwidth is of little value. Hence, using a Gunn diode source, the AM noise is specified in terms of the RMS voltage of an amplifier with a voltage gain of 100,000 across the band 5 Hz - 300 Hz (with a band reject filter at 120 Hz) or, as the RMS voltage output of an amplifier with a voltage gain of 1000 across the 300 Hz - 5000 Hz. .5 mW of RF power is incident on the MA-40074 and sensitivity is approximate 800 mV/mW.



MICROWAVE ASSOCIATES, INC. BURLINGTON, MASSACHUSETTS

Detector Modules And Packaged Detectors

Bulletin 5152

Tunnel Diode Detectors

Schottky Detectors

Zero Bias Schottky Detectors

Schottky Limiter/Detectors

TUNNEL DIODE DETECTORS

- Lowest variation in output response with temperature
- High Sensitivity (TSS) with no external bias applied
- Lowest video impedance for wide video bandwidth and for matching to transistor amplifiers

STANDARD SCHOTTKY DETECTORS

- High Sensitivity (TSS) at low bias level (100 μ A)
- Highest output voltage sensitivity
- High Power Handling, CW and Pulse Peak Power

ZERO BIAS SCHOTTKY DETECTORS

- High Sensitivity (TSS) with no external bias applied
- High Power Handling, CW and Pulse Peak Power
- High output voltage sensitivity

COMPARISON OF GENERAL CHARACTERISTICS OF THE THREE DETECTOR TYPES¹

Parameter	Tunnel Diode Detector	Standard Schottky Detector	Zero Bias Schottky Detector
RF Impedance (Diode)	35–70 Ω	200–400 Ω @ 100 μ A Bias	200–400 Ω
Video Impedance	70–125 Ω	1000–2000 Ω	1500–3000 Ω
CW Power Rating	+ 17 dBm	+ 20 dBm	+ 18 dBm
Peak Power Rating 0.1 μ Sec, .001 Duty Cycle	+ 20 dBm	+ 23 dBm	+ 23 dBm
TSS, dBm, (2 MHz Video Bandwidth)	–50 to –53	–50 to –53 @ 100 μ A Bias	–51 to –53
K (Open Circuit Voltage Sensitivity) mV/mW @ –20 dBm	400 to 1500	1000 to 3500	1000 to 3000
VSWR ²	1.5:1 to 3:1	2:1 to 5:1	2:1 to 5:1
Operating Temperature Range	–65 to +125 ^o	–65 to 125 ^o C	–20 ^o C to 125 ^o C (with slight Bias –65 to +125 ^o C)
CW Saturation	0 to +5 dBm	>+20 dBm	> +20 dBm

NOTES:

1. These performance ranges are typical and depend upon RF Bandwidth and input RF Power level.

2. VSWR depends on bias conditions, DC load resistance and RF output impedance of the signal source.

Octave Bandwidth Tunnel Diode Detectors

MA-7700 Series

DESCRIPTION

The MA-7700 Series of Tunnel (back) Diode Detectors offers greater than octave bandwidth frequency response with excellent voltage sensitivity. These detectors function with a dynamic range of 50 dB with -52 dBm TSS. Burnout rating is +20 dBm. A square law characteristic is maintained for power levels below -10 dBm. Linear response is between -10 dBm and +5 dBm (saturation).

CASE STYLES

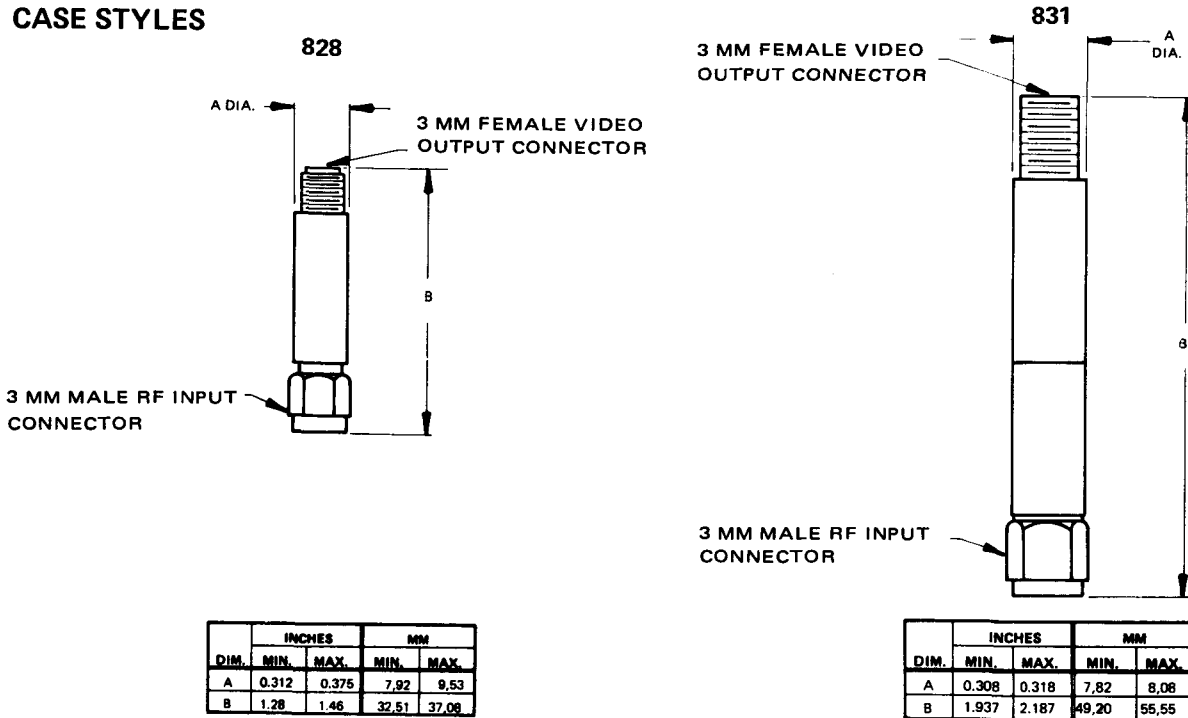

Not to scale.

ELECTRICAL CHARACTERISTICS @ T_A = 25°C

Model Number	Case Style	Frequency Range GHz	Min. Open	Max.	Frequency Response (Flatness) dB	Min.
			Circuit Voltage Sensitivity at -20 dBm mV/mW	VSWR @ -20 dBm 100 Ω Video Load		TSS @ 2 MHz Video Bandwidth -dBm
MA-7700K-0001	831	0.5-2.0	700	2:1	±0.7	52
MA-7700K-0002	831	2.0-4.0	700	2:1	±0.5	52
MA-7700K-0003	831	4.0-8.0	600	2.5:1	±0.7	52
MA-7700A-0004	828	8.0-12.0	700	2:1	±0.5	52
MA-7700A-0005	828	11.0-18.0	500	2:1	±0.7	52

NOTES:

- Custom designs available on request.
- Tunnel Diode Detector Modules and Tunnel Diode Limiter/ Detectors are under development and will be available in near future.
- Output polarity is normally negative. (Positive output polarity is available on request.)



MICROWAVE ASSOCIATES, INC. BURLINGTON, MASSACHUSETTS

Schottky Detector Modules and Packaged Detectors

MA-7707 Series
MA-7709 Series

DESCRIPTION

The MA-7707 Series of modular Schottky detectors is especially designed to fit in microstrip, strip transmission line or other special TEM structures. When packaged, these Schottky detectors are designated MA-7709 Series. These hermetically sealed detectors have high voltage sensitivity and are ideal for broadband applications. The usable power range is from TSS to +17 dBm. Above +17 dBm, the detector response becomes saturated. A wide variety of performance characteristics can be obtained by altering internal circuit configurations (transformations, dc returns, etc.) and external operating conditions. Bias level, size of load, bandwidth, and power level are factors which affect overall performance. The electrical characteristics of the units listed here are representative of an extremely varied and extensive product line.

CASE STYLES

Stripline Detector Modules

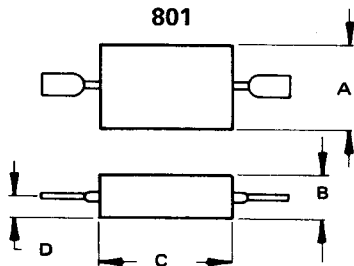

DIM.	INCHES		MM	
	MIN.	MAX.	MIN.	MAX.
A	0.241	0.251	6.12	6.38
B	0.125	0.135	3.18	3.43
C	0.325	0.335	8.26	8.51
D	0.059	0.067	1.50	1.70

Packaged Detector

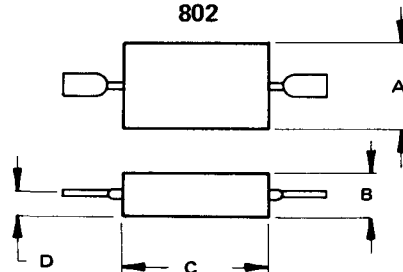

3 MM MALE RF INPUT CONNECTOR

DIM.	INCHES		MM	
	MIN.	MAX.	MIN.	MAX.
A	0.312	0.375	7.92	9.53
B	1.28	1.46	32.51	37.08

Not to scale.

ELECTRICAL CHARACTERISTICS @ $T_A = 25^\circ\text{C}$

Module Model Number	Case Style	Packaged Detector Model Number	Case Style	Frequency Range GHz	Min. Open ¹	Min. TSS @ 2 MHz Video Bandwidth -dBm
					Circuit Voltage Sensitivity at -20 dBm mV/mW	
MA-7707J-0003	801	MA-7709A-0001	828	0.5-2.0	1800	±0.5
MA-7707N-0006	802	MA-7709A-0003	828	2.0-4.0	2000	±0.5
MA-7707N-0008	802	MA-7709A-0005	828	4.0-8.0	2500	±0.5
MA-7707N-0009	802	MA-7709A-0007	828	8.0-12.0	2000	±0.5
MA-7707J-0012	801	MA-7709A-0009	828	12.0-18.0	1800	±0.5
MA-7707J-0013	801	MA-7709A-0011	828	0.5-18.0	1200	±1.5

NOTES:

1. 100 μA forward bias.

2. Output polarity is normally negative.
(Positive output polarity is available on request.)



MICROWAVE ASSOCIATES, INC. BURLINGTON, MASSACHUSETTS

Zero Bias Schottky Detector Modules and Packaged Modules

MA-7742 Series

MA-7744 Series

DESCRIPTION

The MA-7742 series of Zero Bias Schottky Detectors are modular in form. They are designed to fit in microstrip, strip transmission line or other special TEM structures. They are designated MA-7744 series when packaged with connectors. The zero bias detector offers the advantage of high output voltage sensitivity without the need of external bias voltage.

CASE STYLES

Stripline Detector

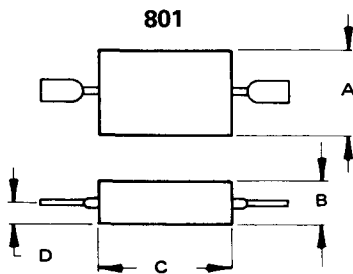

DIM.	INCHES		MM	
	MIN.	MAX.	MIN.	MAX.
A	0.241	0.251	6.12	6.38
B	0.125	0.135	3.18	3.43
C	0.325	0.335	8.26	8.51
D	0.059	0.067	1.50	1.70

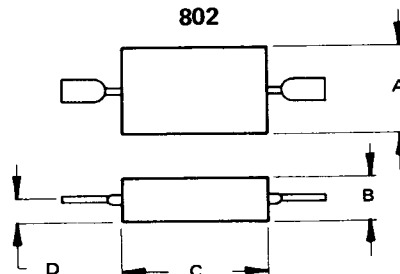

DIM.	INCHES		MM	
	MIN.	MAX.	MIN.	MAX.
A	0.241	0.251	6.12	6.38
B	0.125	0.135	3.18	3.43
C	0.527	0.537	13.39	13.64
D	0.059	0.067	1.50	1.70

Packaged Detector

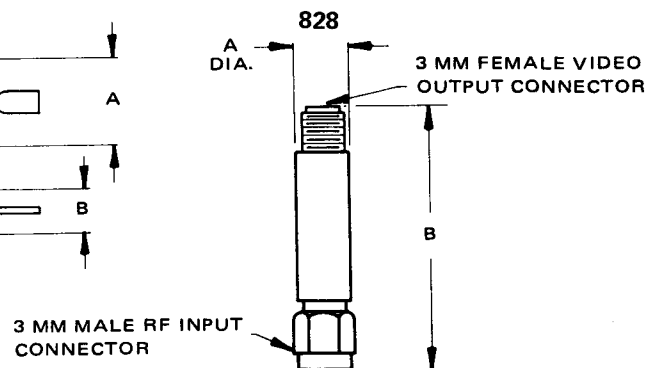

DIM.	INCHES		MM	
	MIN.	MAX.	MIN.	MAX.
A	0.312	0.375	7.92	9.53
B	1.26	1.46	32.51	37.08

Not to scale.

ELECTRICAL CHARACTERISTICS @ $T_A = 25^\circ\text{C}$

Module Model Number	Case Style	Packaged Detector Model Number	Case Style	Frequency Range GHz	Min. Open	Frequency Response (Flatness) dB	Min. TSS @ 2 MHz Video Bandwidth -dBm
					Circuit Voltage Sensitivity at -20 dBm mV/mW		
MA-7742J-0001	801	MA-7744A-0001	828	0.5-2.0	2000	± 0.5	53
MA-7742N-0005	802	MA-7744A-0003	828	2.0-4.0	2200	± 0.5	53
MA-7742N-0007	802	MA-7744A-0005	828	4.0-8.0	3000	± 0.5	54
MA-7742N-0009	802	MA-7744A-0007	828	8.0-12.0	2200	± 0.5	52
MA-7742N-0011	801	MA-7744A-0009	828	12.0-18.0	1800	± 0.5	52
MA-7742N-0012	801	MA-7744A-0012	828	0.5-18.0	1700	± 1.5	51

NOTES:

- Output polarity is normally negative. (Positive output polarity is available on request.)



MICROWAVE ASSOCIATES, INC. BURLINGTON, MASSACHUSETTS

Schottky Limiter/Detector Modules and Packaged Detector

MA-7717 Series

MA-7715 Series

DESCRIPTION

The MA-7717 Series of modular Schottky Limiter/Detectors is specially packaged for use in microstrip, strip transmission or other special TEM structures. When packaged with SMA connectors, these Limiter-Detectors are designated MA-7715 Series. These hermetically sealed Limiter-Detector modules have excellent voltage sensitivity and are ideal for broadband applications. The usable power range is from < -50 dBm to +10 dBm. Above +10 dBm the limiter section protects the sensitive Schottky diode to +40 dBm CW and +60 dBm peak incident power.

CASE STYLES

Stripline Modules

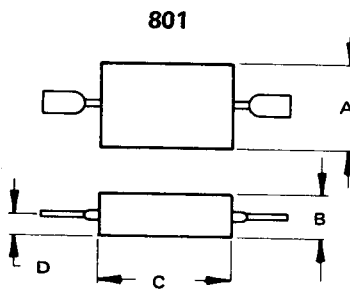

DIM.	INCHES		MM	
	MIN.	MAX.	MIN.	MAX.
A	0.241	0.251	6.12	6.38
B	0.125	0.135	3.18	3.43
C	0.325	0.335	8.26	8.51
D	0.059	0.067	1.50	1.70

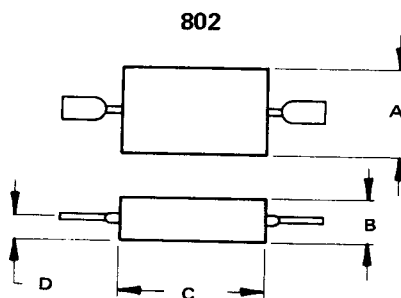

DIM.	INCHES		MM	
	MIN.	MAX.	MIN.	MAX.
A	0.241	0.251	6.12	6.38
B	0.125	0.135	3.18	3.43
C	0.527	0.537	13.39	13.64
D	0.059	0.067	1.50	1.70

Packaged Module 828

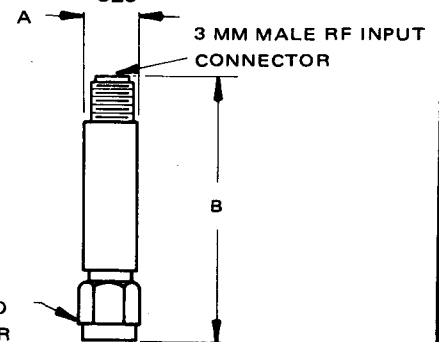

DIM.	INCHES		MM	
	MIN.	MAX.	MIN.	MAX.
A	0.312	0.375	7.92	9.53
B	1.28	1.46	32.51	37.08

Not to scale.

ELECTRICAL CHARACTERISTICS @ $T_A = 25^\circ\text{C}$

Module Model Number	Case Style	Packaged Model Number	Case Style	Frequency Range GHz	Min. Open ¹ Circuit Voltage Sensitivity @ -20 dBm mV/mW	Max. VSWR @ -20 dBm	Frequency Response (Flatness) dB	Min. TSS @ 2 MHz Video Bandwidth -dBm
MA-7717N-0001	802	MA-7715A-0001	828	0.5 - 1.0	1600	4:1	± 3	50
MA-7717N-0002	802	MA-7715A-0002	828	1.0 - 2.0	1700	3.5:1	± 3	50
MA-7717N-0003	802	MA-7715A-0003	828	2.0 - 4.0	2000	3.5:1	± 0.5	50
MA-7717N-0004	802	MA-7715A-0004	828	4.0 - 8.0	2500	4:1	± 0.5	51
MA-7717N-0005	802	MA-7715A-0005	828	8.0 - 12.0	2000	4:1	± 0.75	49
MA-7717N-0006	802	MA-7715A-0006	828	12.0 - 18.0	1400	4:1	± 1.0	48
MA-7717N-0007	802	MA-7715A-0007	828	2.0 - 12.0	1200	4:1	± 1.5	48
MA-7717N-0008	802	MA-7715A-0008	828	6.0 - 18.0	1200	4:1	± 1.5	48
MA-7717J-0009	801	MA-7715A-0009	828	2.0 - 18.0	1200	4:1	± 1.5	47

NOTES:

- Bias is typically 200 μ Amps for low frequency units, 150 μ Amps for S and C Bands, and 100 μ Amps for X and Ku Bands.
- Above bias is typical, but can be optimized for best VSWR and Open Circuit Voltage sensitivity.
- Output polarity is normally negative. (Positive output polarity is available on request.)



MICROWAVE ASSOCIATES, INC. BURLINGTON, MASSACHUSETTS

Tunnel Diodes (Back Diodes) For Mixer And Detector Applications

Bulletin 5050

n-Type Germanium Doppler Mixer Diodes

p-Type Germanium Detector Diodes

p-Type Gallium Arsenide Detector Diodes

GENERAL BACK DIODE CHARACTERISTICS

MA-41807 – 41817 Series (n-type)

Mixer:

- Lowest IF (@ 1 kHz) noise figure at low L. O. drive.
- Able to withstand High incident RF power without degrading IF properties.
- Operation up to 150°C
- High resistance to radiation damage

MA-4C400 Series (p-type)

Detector:

- Lowest variation in output response with temperature
- High sensitivity at zero bias
- Lowest output impedance for wide video bandwidth and for matching to transistor amplifiers.
- High resistance to radiation damage

DESCRIPTION

Microwave Associates Back Diodes are alloyed-junction devices designed for use in microwave mixer and detector applications at frequencies through Ku-band. A wide range of package styles is available to permit the selection of an optimum unit for specific applications in waveguide, coaxial, and stripline transmission systems. These diodes exhibit order-of-magnitude improvements in receiver noise figure for mixer systems utilizing low IF frequencies. Excellent video detector and power monitor performance can be achieved with these diode types. The MA-41807 - MA-41817 diodes have been space-qualified for operating temperatures up to 150°C.

n-Type Back Diodes Germanium

Doppler Mixer Diodes Detector Diodes

CASE STYLES

30

TYPICAL

$$L_p = .30 \text{ nH}$$

$$C_p = .18 \text{ pF}$$

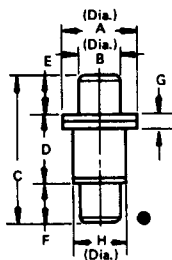

DIM.	INCHES		MM	
	MIN.	MAX.	MIN.	MAX.
A	.119	.127	3.02	3.23
B	.060	.064	1.52	1.63
C	.205	.225	5.21	5.72
D	.085	.097	2.16	2.46
E	.060	.064	1.52	1.63
F	.060	.064	1.52	1.63
G	.016	.024	0.41	0.61
H	.079	.083	2.01	2.11

● Denotes Cathode End

32

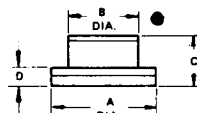

TYPICAL

$$L_p = .30 \text{ nH}$$

$$C_p = 0.3 \text{ pF}$$

DIM.	INCHES		MM	
	MIN.	MAX.	MIN.	MAX.
A	.119	.125	3.02	3.175
B	.077	.083	1.95	2.10
C	.055	.065	1.39	1.65
D	—	.025	—	0.63

158

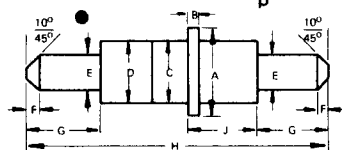

TYPICAL

$$L_p = 0.4 \text{ nH}$$

$$C_p = 0.4 \text{ pF}$$

DIM.	INCHES		MM	
	MIN.	MAX.	MIN.	MAX.
A	.228	.232	5.791	5.892
B	—	.030	—	0.762
C	—	.165	—	4.191
D	.157	.163	3.967	4.140
E	.092	.094	2.336	2.387
F	.010	.030	0.254	0.762
G	.183	.187	4.648	4.749
H	.766	.792	19.456	20.116
J	.185	.180	4.191	4.572

Not to scale.

MAXIMUM RATINGS @ $T_A = 25^\circ\text{C}$ (unless otherwise specified)

Incident CW RF Power	0.5 watt
DC Current	5.0 mA
Operating Temperature	-65°C to $+150^\circ\text{C}$
Storage Temperature	-65°C to $+150^\circ\text{C}$

ENVIRONMENTAL RATINGS PER MIL-STD-750

	Method	Levels
Temperature, Storage	1031	See max. Rating
Temperature, Operating	—	See max. Rating
		10 cycles
Temperature Cycling	1051	See max. Rating
Shock	2016	1200 g's
Vibration	2056	20 g's
Constant Acceleration	2006	20,000 g's
Humidity	1021	10 days

ELECTRICAL CHARACTERISTICS

Mixers

Model ² Number	Case Style	RF Test Frequency GHz	Typ. Conversion Loss ¹ dB	Max. Noise Figure ¹ dB	Typ. IF ¹ Impedance Ohms
MA-41807	158	9.375	7	14.0	300
MA-41808	158	9.375	7	12.0	300
MA-41816	158	9.375	7	10.0	300
MA-41809	30	13.3	8	14.0	300
MA-41810	30	13.3	8	12.0	300
MA-41811	32	13.3	8	14.0	300
MA-41812	32	13.3	8	12.0	300
MA-41817	32	13.3	8	10.0	300

NOTES:

- Conditions: IF = 10 kHz
 $P_{LO} = -10 \text{ dBm}$, dc load = 10 ohms,
 IF Frequency = 10 kHz
 VSWR (max.) = 2.0:1 in holder, IF Amplifier Noise
 Figure = 1.5 dB Nominal.

- All units are available as matched pairs by adding the suffix "M" to the model number. Matching criteria for pairs:

$$\Delta L_C = .3 \text{ dB max.}$$

$$\Delta Z_{if} = 25 \text{ ohms max.}$$



MICROWAVE ASSOCIATES, INC. BURLINGTON, MASSACHUSETTS

ELECTRICAL CHARACTERISTICS (CONT.)

Detector Diodes

Model Number	* Case Style	RF Test Frequency GHz	Typ. Video Impedance Ohms	Typ. Sensitivity mV/mW	Min. TSS ² -dBm
MA-41820	32	13.3	1500	4000	55
MA-41819	158	9.375	1500	4000	55
MA-41813	32	8.375	1500	4000	55

NOTE:

3. Video Bandwidth = 2 MHz.

TYPICAL PERFORMANCE CURVES

FIGURE 1 MA-41817 DOPPLER NOISE FIGURE vs. INTERMEDIATE FREQUENCY

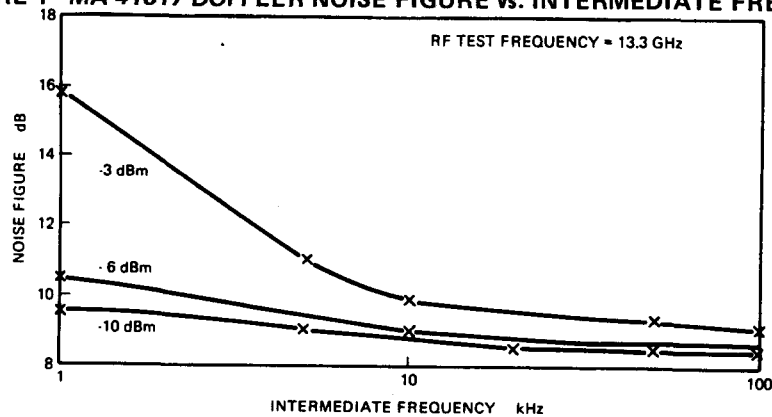

FIGURE 2 MA-41817 DOPPLER NOISE FIGURE vs. L O FREQUENCY

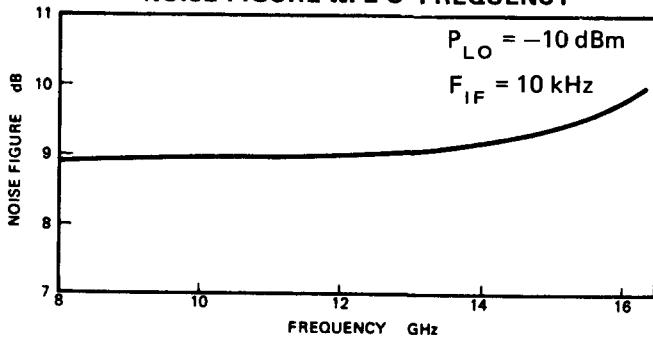

FIGURE 3 MA-41817 Δ NF vs. TEMPERATURE

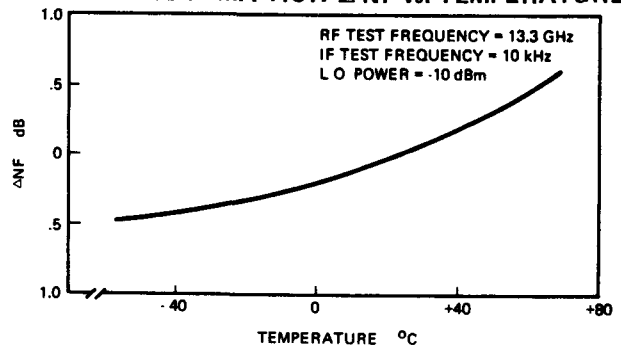
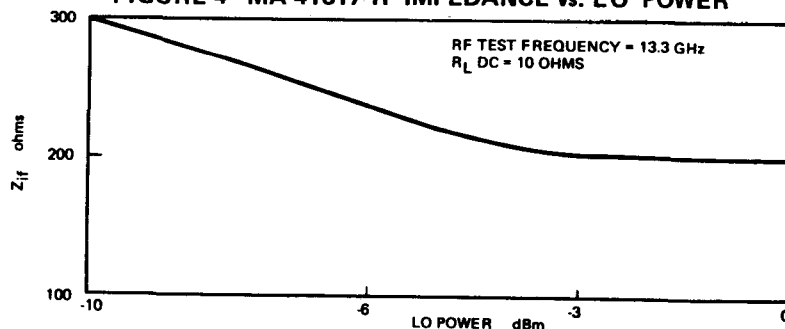

FIGURE 4 MA-41817 IF IMPEDANCE vs. LO POWER



p-Type Back Diodes

Germanium and Gallium Arsenide

Germanium, MA-4C400 Series
Gallium Arsenide
MA-4C850 Series

CASE STYLES

32 - TYPE A

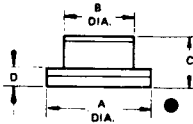

TYPICAL

$$L_p = 0.3 \text{ nH}$$

$$C_p = 0.3 \text{ pF}$$

DIM.	INCHES		MM	
	MIN.	MAX.	MIN.	MAX.
A	.119	.125	3.02	3.175
B	.077	.083	1.95	2.10
C	.055	.065	1.39	1.65
D		.025		0.63

183 - TYPE C

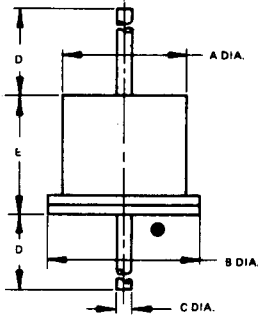

TYPICAL

$$L_p = 0.5 \text{ nH}$$

$$C_p = 0.45 \text{ pF}$$

DIM.	INCHES		MM	
	MIN.	MAX.	MIN.	MAX.
A	0.070	0.080	1.78	2.29
B	0.080	0.110	2.29	2.75
C	0.019	0.022	0.48	0.56
D	1.000	-	2.54	-
E	0.085	0.100	2.18	2.54

182 - TYPE B

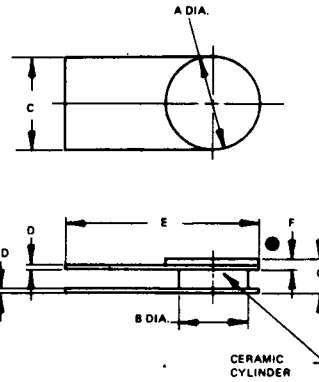

TYPICAL

$$L_p = 0.3 \text{ nH}$$

$$C_p = 0.35 \text{ pF}$$

DIM.	INCHES		MM	
	MIN.	MAX.	MIN.	MAX.
A	0.110	0.130	2.75	3.30
B	0.085	0.095	2.16	2.41
C	0.115	0.130	2.92	3.30
D	0.003	0.007	0.08	0.18
E	0.230	0.270	5.84	6.86
F	0.010	0.020	0.25	0.51
G	0.035	0.055	0.89	1.40

189 - TYPE D1

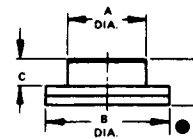

TYPICAL

$$L_p = 0.1 \text{ nH}$$

$$C_p = 0.36 \text{ pF}$$

DIM.	INCHES		MM	
	MIN.	MAX.	MIN.	MAX.
A	0.045	0.055	1.14	1.40
B	0.078	0.082	1.98	2.08
C	0.015	0.019	0.38	0.48
D	0.027	0.034	0.69	0.86

188

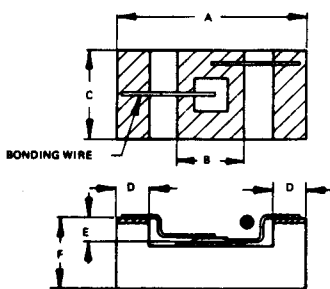

TYPICAL

$$L_p = \text{See Note 3.}$$

$$C_p = \text{See Note 3.}$$

DIM.	INCHES		MM	
	MIN.	MAX.	MIN.	MAX.
A	0.065	0.080	1.40	1.52
B	0.020	-	0.51	-
C	0.024	0.030	0.61	0.76
D	0.007	0.014	0.18	0.36
E	0.007	-	0.18	-
F	0.017	0.027	0.43	0.69

191 - TYPE D2

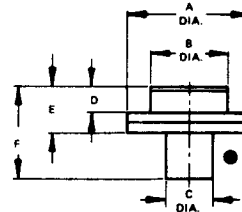

TYPICAL

$$L_p = 0.1 \text{ nH}$$

$$C_p = 0.36 \text{ pF}$$

DIM.	INCHES		MM	
	MIN.	MAX.	MIN.	MAX.
A	0.078	0.082	1.98	2.08
B	0.045	0.055	1.14	1.40
C	0.038	0.042	0.97	1.07
D	0.015	0.018	0.38	0.48
E	0.027	0.034	0.69	0.86
F	0.048	0.059	1.22	1.50

190 - TYPE D

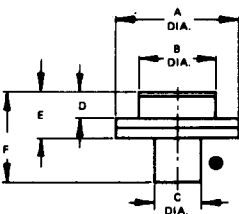

TYPICAL

$$L_p = 0.1 \text{ nH}$$

$$C_p = 0.36 \text{ pF}$$

DIM.	INCHES		MM	
	MIN.	MAX.	MIN.	MAX.
A	0.078	0.082	1.98	2.08
B	0.045	0.055	1.14	1.40
C	0.025	0.029	0.64	0.74
D	0.015	0.019	0.38	0.48
E	0.027	0.034	0.69	0.86
F	0.048	0.059	1.22	1.50

● Denotes Cathode End

Not to scale.



MICROWAVE ASSOCIATES, INC. BURLINGTON, MASSACHUSETTS

MAXIMUM RATINGS @ T_A = 25°C
(unless otherwise specified)

Incident CW RF Power	20 mW
Operating Temperature	-65°C to +100°C
Storage Temperature	-65°C to +100°C

ENVIRONMENTAL RATINGS PER MIL-STD-750

	Method	Levels
Temperature, Storage	1031	See max. Rating
Temperature, Operating	-	See max. Rating 10 cycles
Temperature Cycling	1051	See max. Rating
Shock	2016	1200 g's
Vibration	2056	1200 g's
Constant Acceleration	2006	20,000 g's
Humidity	1021	10 days

ELECTRICAL CHARACTERISTICS @ T_A = 25°C

Germanium Back Diodes

MA Type	KMC Type	Max. I _p μA	Max. V _f mV	Max. C _t pF	Typ. V _r mV
MA-4C400	GBDX25	25	160	1.0	330
MA-4C401	GBDX50	50	140	1.0	350
MA-4C402	GBD100	100	120	1.0	375
MA-4C403	GBD250	250	100	1.0	390
MA-4C404	GBD400	400	100	1.0	390
MA-4C405	GBD500	500	80	1.0	390

Gallium Arsenide Back Diodes

MA Type	KMC Type	Max. I _p μA	Max. V _f mV	Max. C _t pF	Typ. V _r mV
MA-4C850	ABDX25	25	300	2.5	675
MA-4C851	ABDX50	50	260	2.5	700
MA-4C852	ABD100	100	225	2.0	725
MA-4C853	ABD250	250	200	1.5	750

Add Suffix "A", "B", "C", "D", "D1", "D2", or "188" after part number to specify case style.

NOTES:

- Max. DC Current
Germanium: 50 MA (or 2 x I_p whichever is greater)
Gallium Arsenide: Forward Current (I_F) must be restricted to a value in milliamps equal to or less than one half the junction capacitance in pf.
- Definitions: V_f measured at I_f = 3 mA
V_R measured at I = I_p
- Case parasitics are dependant on Chip Mounting Configuration.

TYPICAL MEASURED VALUES – GERMANIUM BACK DIODES FOR VIDEO DETECTORS

M/A Type	KMC Type	Test Frequency GHz	Tangential* Sensitivity -dBm	γ mV/mW	Figure of Merit γ / √R _v	Video Resistance Ohms	Output Saturation Voltage mV
MA-4C401	GBDX50A	2	56	6000	250	500	180
		4	53	3000	130	500	180
		8	50	1500	65	500	180
MA-4C402	GBD100A	2	57	2600	180	200	190
		4	54	2200	150	200	190
		8	52	1000	70	200	190
MA-4C403	GBD250A	2	52	925	100	80	250
		4	52	850	95	80	250
		8	52	850	95	80	250

*Calculated –

$$P_{TSS} = \frac{3.22 \sqrt{BF}}{M} \times 10^{-7} \text{ mW}$$

- B = Bandwidth (2 MHz)
 F = Noise Figure (3 dB)
 M = Figure of Merit

TYPICAL PERFORMANCE CURVES

FIGURE 1 TYPICAL BACK DIODE CURRENT-VOLTAGE CHARACTERISTIC

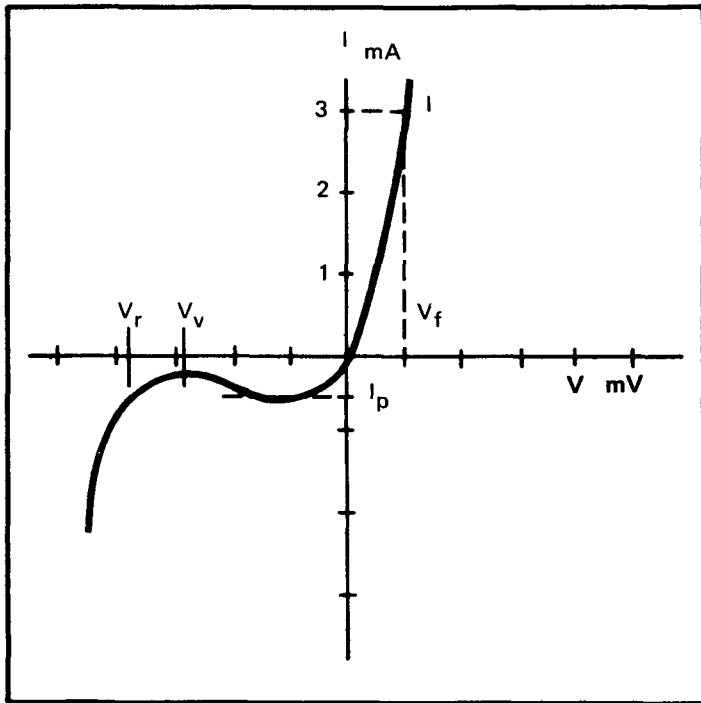

FIGURE 3
BACK DIODE OUTPUT VOLTAGE
CHARACTERISTIC vs. FREQUENCY
MA-4C404

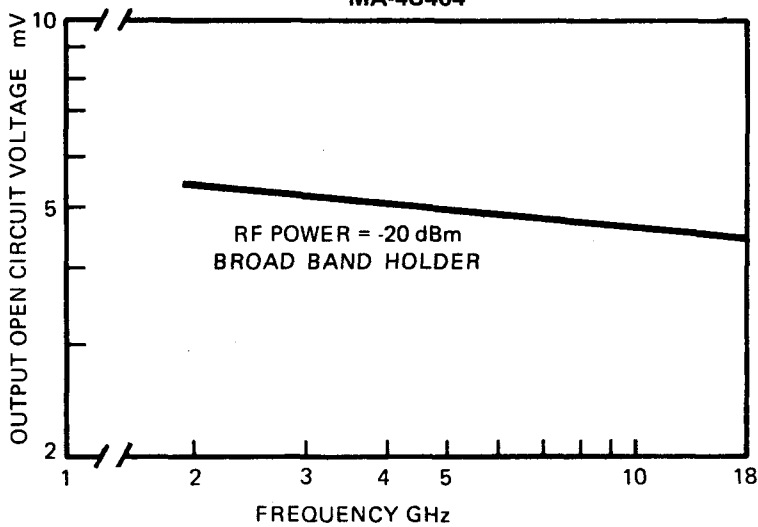

FIGURE 2

OUTPUT VOLTAGE vs. INPUT POWER

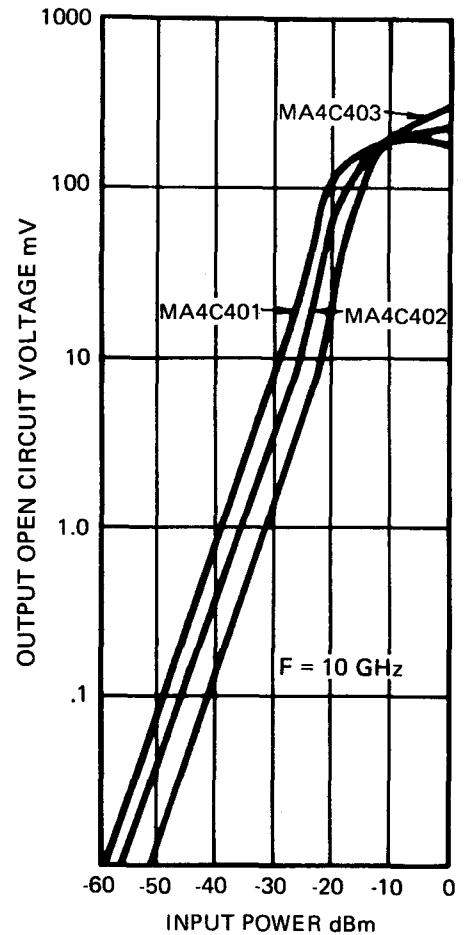
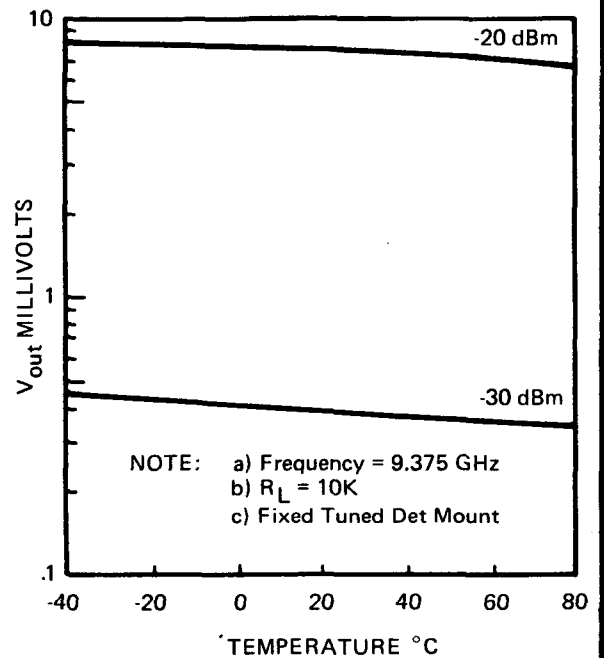

FIGURE 4
BACK DIODE OUTPUT VOLTAGE
CHARACTERISTIC vs. TEMPERATURE
MA-4C404



Schottky Barrier Diodes for Frequency Up-conversion Applications

Bulletin 4252

Upconverter Diodes

Modulator Diodes

STRIPLINE SCHOTTKY UP-CONVERTER DIODES

DESCRIPTION

These Stripline Schottky Up-Converter Diodes are made with bonded planar passivated Schottky junctions, designed specifically for high conversion efficiency in up-converter applications. The diodes are packaged in a miniature stripline package with a plastic coating which protects the diode from mechanical abrasion. It is designed for MIC, stripline and microstrip circuit usage from 100 MHz through X-band.

STRIPLINE SCHOTTKY MODULATOR DIODES

DESCRIPTION

These Stripline Schottky Modulator Diodes are made with bonded planar Schottky junctions. The small junction capacitance and low series resistances are designed specifically for high conversion efficiency in modulator applications. The diodes are packaged in a miniature stripline package with a plastic coating which protects the diode from mechanical abrasion. It is designed for MIC, stripline, and microstrip circuit usage from 100 MHz through X-band.

PACKAGE DESCRIPTION

Case Style 137 is a stripline package with gold-plated Cu leads. The leads provide a good transmission line up to the diode which is in series with the line. The package is designed for use from 100 MHz through X-band. The leads can be soldered per MIL-STD-202, method 208, with maximum solder temperature of 230°C for 5 seconds.

Stripline Schottky Up-Converter Diodes

MA-40060 Series

CASE STYLE

137

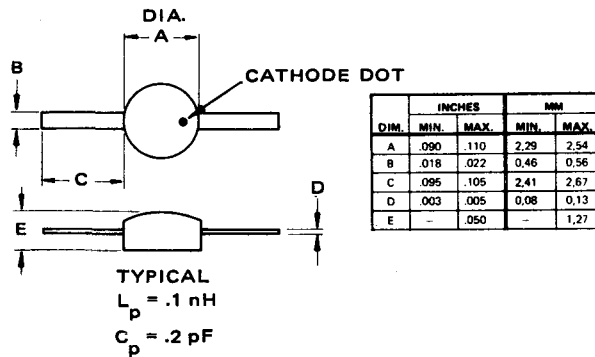

MAXIMUM RATINGS @ T_A = 25°C

Incident RF CW Power	100 mW	Temperature:	
Incident RF Peak Pulse Power (3 ns Max. pulse width, 1000 pps)	2.0 Watts	Operating	-65 to +125°C
DC Forward Current	50 mA	Storage	-65 to +125°C

TYPICAL ELECTRICAL PARAMETERS

All Models			
Package Capacitance (C _p)	.2 pF	Junction Capacitance (C _j)	0.1 pF
Series Resistance (R _s)	10 Ω	Breakdown Voltage @ -10 μA (V _b)	3.0 V

ELECTRICAL CHARACTERISTICS @ T_A = 25°C

Model ³ Number	Case Style	Test Frequency GHz	Max. USUC ^{1,4} Loss dB	Max. VSWR ²
MA-40061	137	6.0	9.0	1.5
MA-40062	137	6.0	10.0	2.0

NOTES:

1. USUC = Upper Sideband Upconverter
2. Carrier power = + 10 dBm; signal ports terminated with 50Ω.
3. All units available as matched pairs by adding suffix "M". Matching criteria: Δ (USUC loss) ≤ .3 dB
4. Test Conditions: USUC loss is the ratio of pump power to output power at the upper sideband.

Pump Power = +13 dBm

IF Signal Power = +15 dBm



MICROWAVE ASSOCIATES, INC. BURLINGTON, MASSACHUSETTS

TYPICAL PERFORMANCE CURVES

FIGURE 1 INPUT VSWR, PUMP PORT VS. PUMP POWER, MA-40061

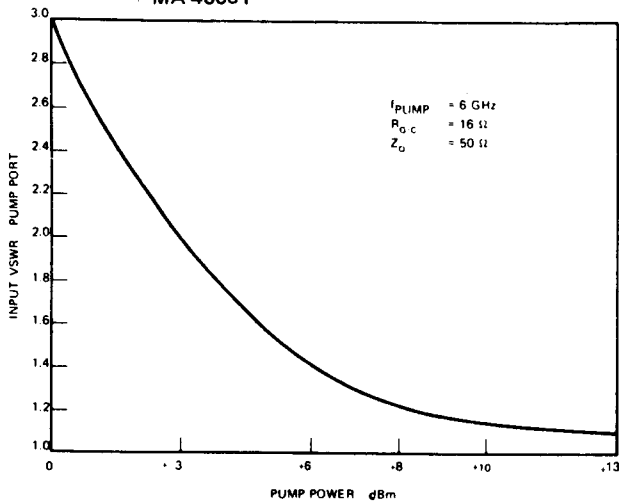

FIGURE 2 MA-40061 USUC LOSS VS. IF INPUT POWER, SINGLE DIODE UP-CONVERTER

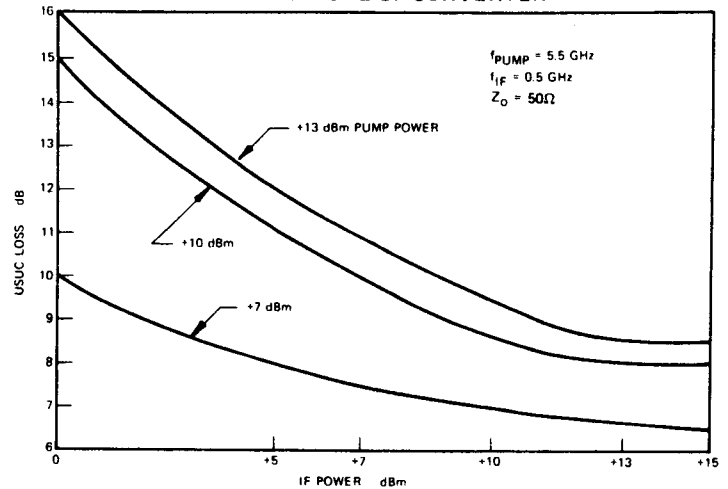
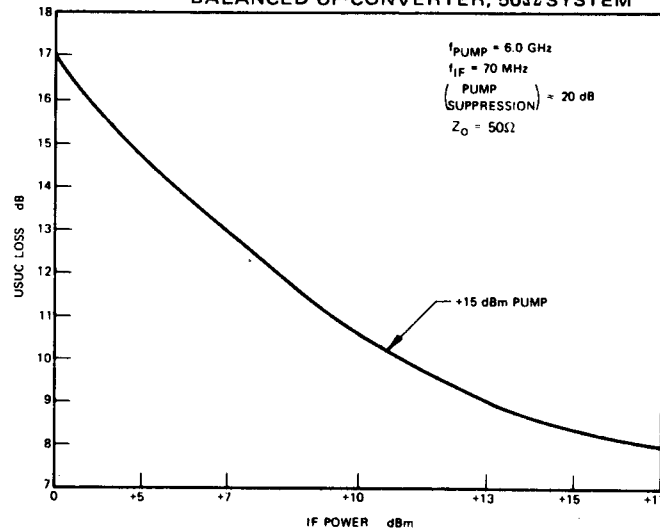

FIGURE 3 MA-40061 USUC LOSS VS. IF INPUT POWER, BALANCED UP-CONVERTER, 50Ω SYSTEM



APPLICATION NOTES

A balanced up-converter may be thought of as a balanced mixer "operated backwards." The IF bandwidth of the balanced structure must be wide enough to pass the input signal that is to be up-converted. Up-conversion generally implies that the pump-to-sideband separation is relatively large. Pump suppression is the result of microwave structure symmetry, diode matching and of optimum pump and signal power levels.

If the input signal is small, compared to the pump power, then the frequency conversion process is linear and the mixer structure is effectively being operated backwards. The more usual applications call for relatively high output power at the upper sideband. Because high signal and pump powers are required to obtain the required sideband power, special Schottky diodes are constructed for this application.

Typical performance curves show pump port VSWR vs. pump power (Figure 1), USUC (Upper Sideband Up-Converter) loss for a single diode up-converter (Figure 2), and for a balanced up-converter (Figure 3). Harmonic content and pump suppression are functions of the up-converter circuit design and of the signal-to-pump power ratio, which must be optimized empirically.

Stripline Schottky Modulator Diodes

MA-40080 Series

CASE STYLE

137

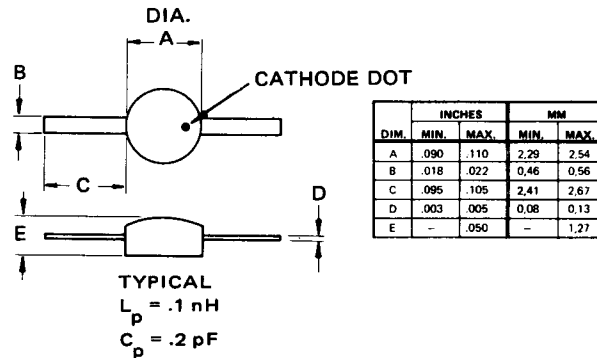

MAXIMUM RATINGS @ $T_A = 25^\circ\text{C}$

RF CW Power	100mW	Temperature:	
RF Peak Pulse Power (3 ns pulse width 1000 pps)	2.0 Watts	Operating	-65 to +125° C
DC Forward Current	50 mA	Storage	-65 to +125° C

TYPICAL ELECTRICAL PARAMETERS

All Models

Package Capacitance (C_p)	.2 pF	Junction Capacitance (C_j)	0.1 pF
Series Resistance (R_s)	10 Ω	Breakdown Voltage @ $-10 \mu\text{A}$ (V_b)	3.0 V

ELECTRICAL CHARACTERISTICS @ $T_A = 25^\circ\text{C}$

Model ³ Number	Case Style	Test Frequency GHz	Max. SSB ^{1, 4}	
			Loss dB	Max. VSWR ²
MA-40081	137	6.0	9	1.5
MA-40082	137	6.0	10	2.0

NOTES:

- SSB = Single Sideband
- Carrier power = +10 dBm, signal ports terminated with 50 Ω
- All units available as matched pairs by adding suffix "M". Matching criteria Δ (SSB loss) $\leq .3$ dB.
- Test Conditions: SSB loss is the ratio of carrier power divided by the output power at one sideband. Carrier power = +10 dBm, dBm, Signal power = +17 dBm.



MICROWAVE ASSOCIATES, INC. BURLINGTON, MASSACHUSETTS

TYPICAL PERFORMANCE CURVES

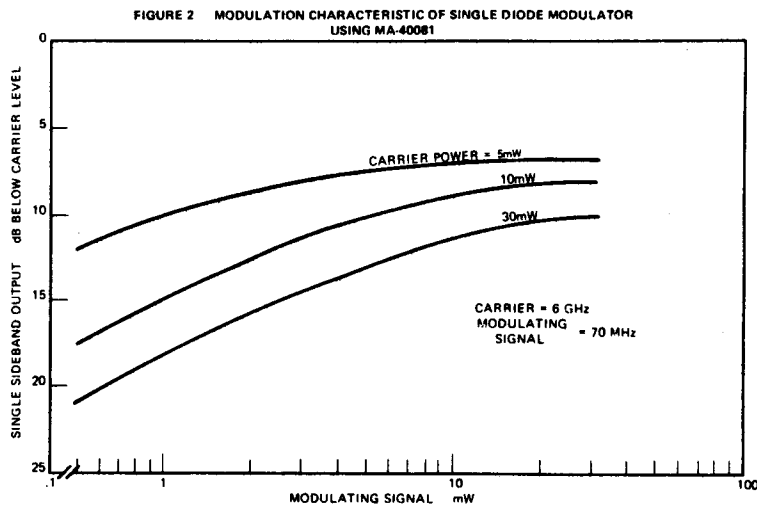
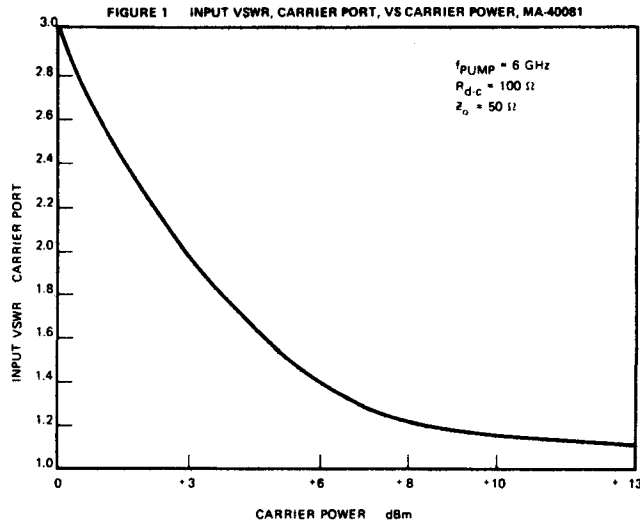

MICROWAVE DIODE MODULATOR

Modulators convert low frequency signals to high frequencies. Small signal modulation is the reciprocal process to small signal mixing. The carrier power is much larger than the signal power, ensuring that the output signal will be a faithful replica of the input signal. Relatively small sideband power outputs are available.

To provide relatively high output power, the MA-40080 Series of Schottky diodes is specifically designed to operate efficiently in the large signal (switching) mode. When the input signal power is significantly higher than the carrier power, the input signal assumes the switching role; and conversion loss must be calculated from carrier input to first-order sideband output. Assuming equal source and load impedances terminating all ports of a single balanced modulator, the carrier source is connected to the output load during alternate half cycles of the input signal. In this case, conversion loss to each first-order sideband (by Fourier Analysis of the output waveform) is 10dB. Conversion loss is less for optimized source and load impedance.

A singularly Balanced Modulator (SBM) suppresses the modulated carrier and provides output power at the first-order sidebands and at higher-order sidebands. Typically, carrier suppression may be 20 to 25 dB; and the even-order sidebands may be suppressed below the odd-order sidebands by about 20 dB. Suppression depends on the symmetry of the hybrid circuit, the matching criteria of the diodes and on empirical optimizing of the Signal-to-Carrier Power Ratio. A single sideband output can be obtained from a Doubly Balanced Modulator (DBM). Additional suppression of the carrier and of the even-order sidebands is obtained.

MA-47160 Series

PICOSECOND SWITCHING DIODES

for Digital or Logic Circuits

Bulletin 4309

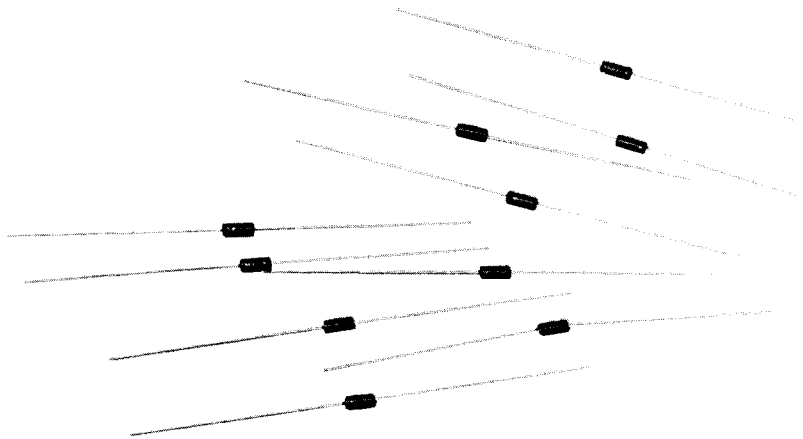

FEATURES

- Low Cost – attractive for general purpose applications
- Fast Switching – Picosecond switching for high speed digital or logic circuits
- High Breakdown Voltage – 70 volt breakdown permits use in high voltage sampling gates
- Low Lifetime – permits use in large dynamic range mixer and detector circuits through UHF band

APPLICATIONS

- High Level Detection (Audio through UHF)
- Switching or gating
- Log or Analog – Digital Converters
- Sampling or wave shaping
- Low level detection and frequency discrimination

DESCRIPTION

The MA-47160 Series of switching diodes is a family of epitaxial, oxide passivated devices that exhibit ultrafast switching characteristics and high breakdown voltages.

MAXIMUM RATINGS – MA-47160 Series

Power Dissipation @ 25°C	250 mW
Derate 1.43 mW/°C for Temperature Range 25°C to 200°C	
Operating Temperature Range	-65 to +200°C
Storage Temperature Range	-65 to +200°C

SPECIFICATIONS

Electrical Specifications @ 25°C

Symbol	Parameter	Test Conditions	MA-47160 ¹		MA-47161 ¹		MA-47162 ¹	
			Min.	Max.	Min.	Max.	Min.	Max.
V _B	Breakdown Voltage (Volts)	I _R = 10 μA	70	-	20	-	15	-
V _F	Forward Voltage (mV)	I _F = 1 mA	-	410	-	410	-	410
I _F	Forward Current (mA)	V _F = 1	15	-	35	-	20	-
I _R	Reverse Leakage Current (nA)		-	200	-	100	-	100
			@ 50 V	-	@ 15 V	-	@ 8 V	-
C _T	Capacitance (pF)	V _R = 0 V f = 1 MHz	-	2.0	-	1.2	-	1.2
τ	Effective Minority Carrier Lifetime (ps)	I _F = 5 mA	-	100	-	100	-	100

NOTE:

1. All diodes in the MA-47160 Series are packaged in Case Style 54.

All specifications are subject to change without notice.

CONTROL DIODES

SELECTION GUIDE - PIN Diodes	88
PIN Diodes for High Power Applications	89
PIN Diodes for Fast Switching and Limiting Applications	99
PIN Diodes for General Purpose and Attenuation Applications	109
VHF - UHF PIN Diode TR Switch	115
PIN Stripline Devices	117
PIN Diode Modules	127
Tuning Varactors	135
Tunnel Diodes for Switching Applications	136

CONTROL DIODES

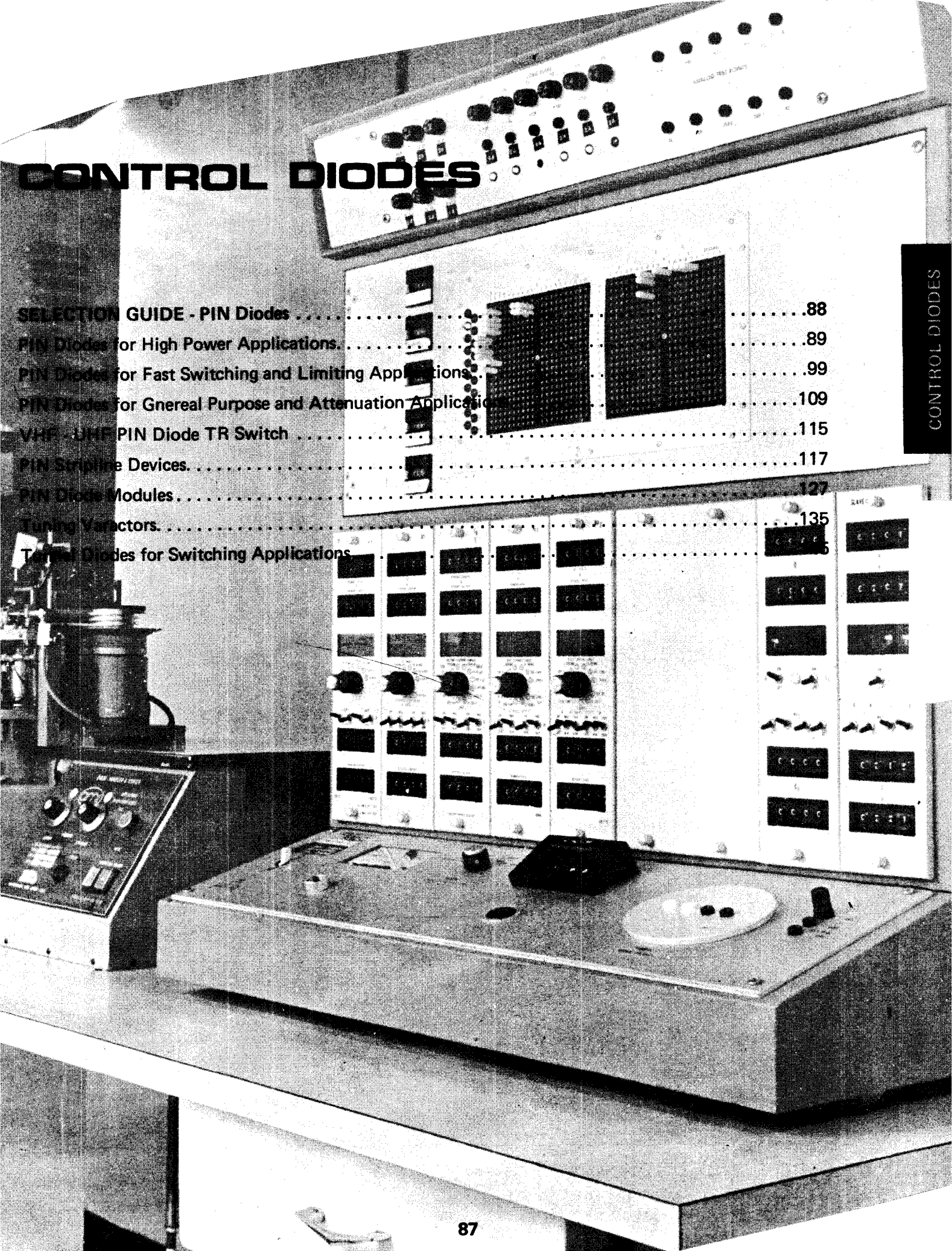

SELECTION GUIDE-PIN DIODES

Case Styles	Application				
	High Power Switching	General Purpose Switching	Attenuation	Fast Switching	Limiting
Glass		MA-47100 MA-47047 MA-47120 MA-47600 MA-47054 MA-47123 MA-47121 MA-47122	MA-47111 MA-47083 1N5719 MA-47047 MA-47123 MA-47110	MA-47041 MA-47053 MA-47054	MA-47089
Ceramic and Pill Packages	MA-47084 MA-47075 MA-47079 MA-47077 MA-47080 MA-47081	MA-47082	MA-47084 MA-47075 MA-47079 MA-47077 MA-47080 MA-47081	MA-47051 MA-47052	MA-47085 MA-47091
Stripline	MA-47200 MA-47220 MA-47201 MA-47202 MA-47203 MA-47204 MA-47208	MA-47220 MA-47221 MA-47222 MA-47205 MA-47206	MA-47220 MA-47221 MA-47222 MA-47205 MA-47206	MA-47205 MA-47206 MA-47220	MA-47222
Beam Leads		MA-47301 MA-47302	MA-47301 MA-47302	MA-47301 MA-47302	
Chips	MA-47400 MA-47401 MA-47402 MA-47403 MA-47404 MA-47405	MA-47418 MA-47420 MA-47416 MA-47403 MA-47404 MA-47405 MA-47406 MA-47407 MA-47408 MA-47421 MA-47422	MA-47400 MA-47401 MA-47402 MA-47403 MA-47404 MA-47405 MA-47406 MA-47407	MA-47408 MA-47424 MA-47425 MA-47426 MA-47427	MA-47410 MA-47414



MICROWAVE ASSOCIATES, INC. BURLINGTON, MASSACHUSETTS

PIN Diodes For High Power Applications

Bulletin 4352

CONTROL DIODES

Metal–Ceramic Packages

Hard Glass Passivated Chips

Microwave Associates, Inc. 

DESCRIPTION

This series of high power PIN switching devices consists of hermetic hard glass passivated chips and packaged diodes using these chips. These Cermachip™ PIN diode chips are impervious to moisture because they are sealed in a layer of ultra-pure high temperature hard glass. Ranges of breakdown voltage and diode capacitance as well as several package styles are available for particular applications.

APPLICATIONS

These diodes are designed for use in medium and high power RF switches, phase shifters, duplexers, and attenuators. The chip diodes are particularly well suited for mounting in microwave integrated circuits and modules.

FEATURES

- Hermetically sealed chips
- High breakdown voltage
- Low Thermal Resistance
- Low Capacitance (to 0.1 pF)
- Low series resistance
- Excellent Reliability

High Power PIN Switching Diodes

Ceramic Packages

CASE STYLES

30

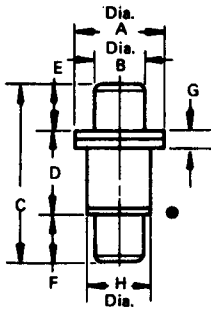

TYPICAL
 $L_p = 0.40 \text{ nH}$
 $C_p = 0.18 \text{ pF}$

DIM.	INCHES		MM	
	MIN.	MAX.	MIN.	MAX.
A	.119	.127	3.02	3.23
B	.060	.064	1.52	1.63
C	.205	.225	5.21	5.72
D	.085	.097	2.16	2.46
E	.060	.064	1.52	1.63
F	.060	.064	1.52	1.63
G	.016	.024	0.41	0.61
H	.079	.083	2.01	2.11

109

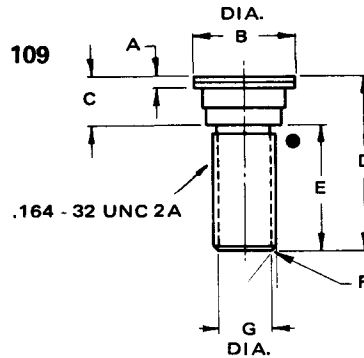

TYPICAL
 $L_p = .6 \text{ nH}$
 $C_p = 0.75 \text{ pF}$

DIM.	INCHES		MM	
	MIN.	MAX.	MIN.	MAX.
A	0.027	0.033	0.69	0.84
B	0.259	0.267	6.6	6.8
C	0.118	0.134	3.0	3.4
D	-	0.446	-	11.35
E	0.317	0.323	8.05	8.25
F	40°	50°	-	-
G	0.110	0.130	2.794	3.302

Not to scale.

NOTE: • Indicates Cathode End.

ABSOLUTE MAXIMUM RATINGS¹

Temperature Range:

Operating

-65 to +175°C

Storage

-65 to +175°C

$$\text{CW Power Dissipation}^1 \text{ (Watts) @ } T_{op} = \frac{(175 - T_{op})}{\theta_{JC}}$$

Where: T_{op} = Operating Temperature (°C)

θ_{JC} = Thermal Resistance (°C/W)

ELECTRICAL CHARACTERISTICS @ $T_A = 25^\circ\text{C}$

Model Number	Case Style	Min. Breakdown Voltage Volts	Total Capacitance ² pF		Max. Series Resist. Ohms	Max. Thermal Resist. °C/W
			Min.	Max.		
MA-47084	109	1000	2.6	3.8	0.3 @ 150 mA	5
MA-47075	30	1000	0.2	0.5	1.2	30
MA-47077	30	1000	0.5	0.8	0.7	25
MA-47079	30	500	0.2	0.4	0.6	20
MA-47080	30	500	0.4	0.7	0.45	15
MA-47081	30	500	0.7	1.0	0.3	10
MA-47082	30	300	0.2	0.4	0.6 @ 50 mA	20
Test Conditions	—	$I_R = 10 \mu\text{A}$	$V_R = -100\text{V}$ $f = 1.0 \text{ MHz}$		$I_F = 100 \text{ mA}$ $f = 500 \text{ MHz}$	—



MICROWAVE ASSOCIATES, INC. BURLINGTON, MASSACHUSETTS

TYPICAL CHARACTERISTICS @ T_A = 25°C

Model Number	Dynamic ³ Q	Minority ⁴ Carrier Lifetime μS	Peak ⁵ Power Handling kW	Reverse ⁶ Switching Time - t _{FR} nS	Forward ⁶ Switching Time - t _{RF} nS
MA-47084	300	5.0	30	650	300
MA-47075	450	3.0	12	150	150
MA-47077	350	4.0	16	350	150
MA-47079	650	1.5	8	100	30
MA-47080	600	1.5	8	150	30
MA-47081	500	2.0	8	200	60
MA-47082	500	0.8	3	75	30

NOTES:

- The MA-47084 PIN switching diode exceeds the stated maximum temperature ratings with an operating temperature range up to +200°C and a storage range of up to 250°C. CW power dissipation is thus correspondingly increased.
- The capacitance of the MA-47084 is measured at -250 Volts and the MA-47082 is measured at -50 Volts.
- Dynamic Q is defined as $\frac{1}{2\pi f C_T \sqrt{R_R R_F}}$ where R_R and R_F are reverse and forward bias resistance respectively, and gives information regarding the maximum frequency at which the diodes may be used, and the insertion loss and isolation. Typical values, obtained at f = 1 GHz and -100V and +100 mA biases, are given in the table above. The bias conditions for the MA-47084 are 150 mA and -250V; for the MA-47082, they are 50 mA and -50V. All others are +100 mA and -100V. For additional information, see M. E. Hines' "Fundamental Limitations in RF Switching and Phase Shifting Using Semiconductor Diodes". Proc. IEEE, 53:697(1964).
- I_F = 10 mA, I_R = 6 mA
- The diode is mounted in a 50 Ohm line. Pulsewidth is 1 μS, with a low repetition rate, such that average heating effects can be neglected. The frequency is 1 GHz. Data on the MA-47084 is taken at 3.3 GHz, V_R = 250V and t_p = 10 μS.
- The speed with which the diodes will switch RF power depends on the shape of the waveform and the bias conditions. The typical data section shows switching times measured using the circuit of Figure 1; t_{fr} is from forward to reverse bias, and t_{rf} is from reverse to forward bias. The MA-47082 is measured between 50 mA forward and 50V reverse; the MA-47084 is measured at 150 mA and 100V; all others from 100V to +100 mA or vice versa.

SERIES AND SHUNT MOUNT DIODES

Power Handling Data

SERIES MOUNTING

	Peak Power	Forward Bias	Peak Power	Reverse Bias
	kW	mA	kW	V
MA-47075	64	100	3	100
MA-47077	100	100	4	100
MA-47079	48	100	2	100
MA-47080	64	100	2	100
MA-47081	96	100	2	100
MA-47082	16	50	1	100
MA-47084	-	-	-	-

SHUNT MOUNTING

	Peak Power	Forward Bias	Peak Power	Reverse Bias
	kW	mA	kW	V
	16	100	12	100
	25	100	16	100
	12	100	8	100
	16	100	8	100
	24	100	8	100
	4	50	3	100
	16	100	30	250

This data was obtained by measurement and calculation as follows:

With the diode series mounted in a 50 Ω coaxial line, the reverse bias power handling was obtained by measuring the dc leakage current and was 3 kW during the pulse for the MA-47075 at 100 V bias. This power level corresponds to a peak voltage, given by:

$$V_{\text{peak}} = 2 \sqrt{2 \times P \times Z_0} + 100 \text{ V Bias} = 1200 \text{ V}$$

With shunt, mounting in a 50 Ω line, the corresponding power handling capability is given by:

$$P = \frac{V_{\text{rms}}^2}{Z_0} = 12 \text{ kW}$$

This shows that the reverse bias power handling capability of the diode is inversely proportional to the line impedance.

POWER HANDLING: (Continued)

Under forward bias, power handling considerations are principally thermal. For a low duty cycle, the power handling can be calculated from the transient thermal resistance at the particular pulse width, the percentage of incident power which will be dissipated in the diode, and the allowable temperature rise before burnout. For short pulses, the junction temperature can reach 300°C before burnout occurs.

The transient thermal resistance for various pulse widths was measured by monitoring the voltage across the diode at the end of the RF pulse. From the change in this voltage between the beginning and the end of the pulse, the temperature rise in the diode can be obtained. Knowing the power dissipated in the diode, the thermal resistance is calculated. The results are shown on Figure 7 under typical performance curves.

From these numbers, the power handling capability under forward bias in any configuration can be calculated.

With a 1 μs pulse width, at 1 GHz, the diode can safely dissipate 1375 W peak. At 100 mA bias, this corresponds to a maximum RF current of 36 A for the MA-47075.

Thus, this diode, when shunt mounted in a 50 Ω line, is capable of withstanding an incident peak power given by:

$$P_{in} = \left(\frac{I_{max.}}{2} \right)^2 \times Z_o = 16 \text{ kW}$$

This shows that the forward bias power handling capability of the diode is directly proportional to the line impedance.

Therefore, there is some optimum value of line impedance for both shunt and series mounted diodes which will result in equal power handling in both directions. However, for a shunt mounted diode, this impedance may not give optimum insertion loss and isolation, which increase as the line impedance is decreased.

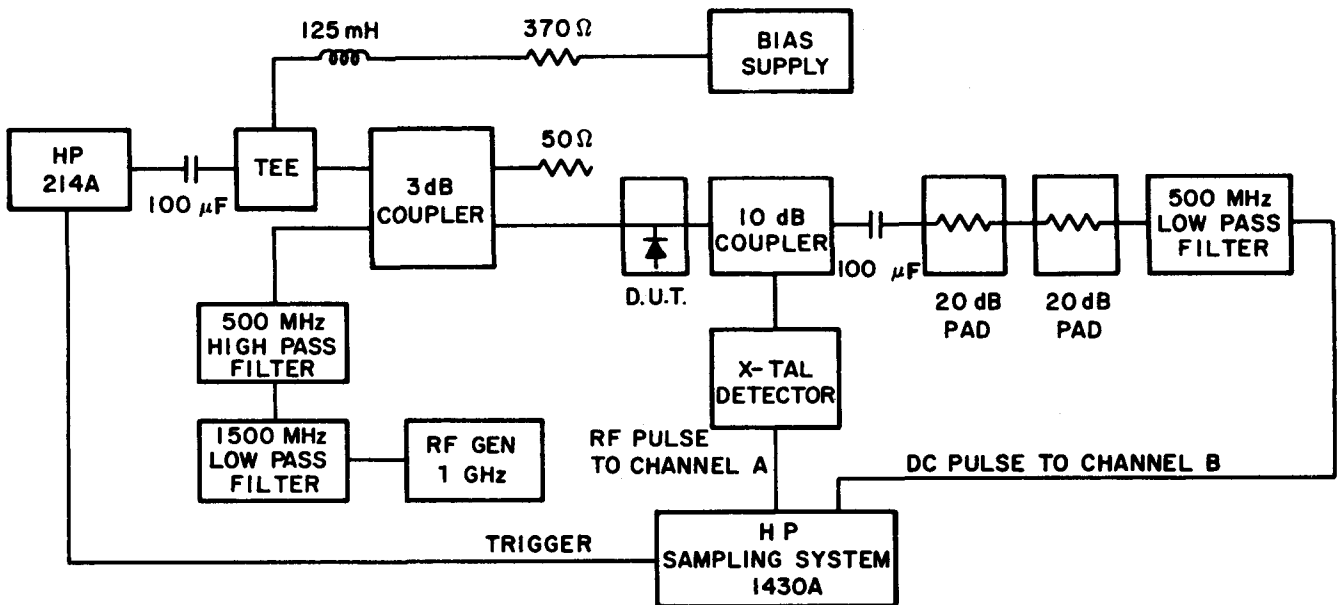

FIGURE 1 TEST CIRCUIT FOR SWITCHING TIME

TYPICAL PERFORMANCE CURVES

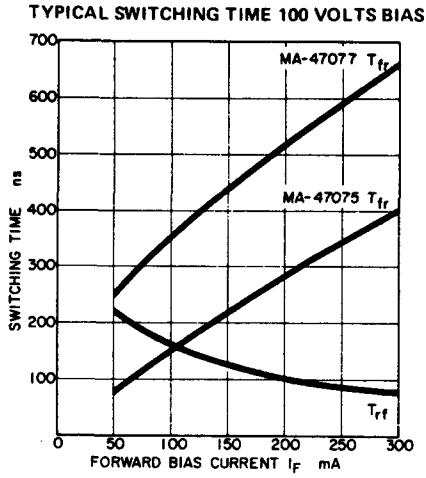

FIGURE 2

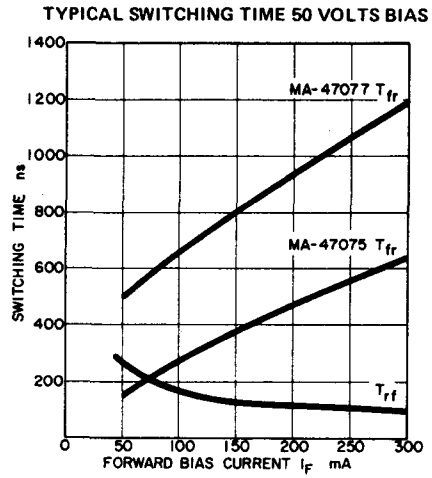

FIGURE 3

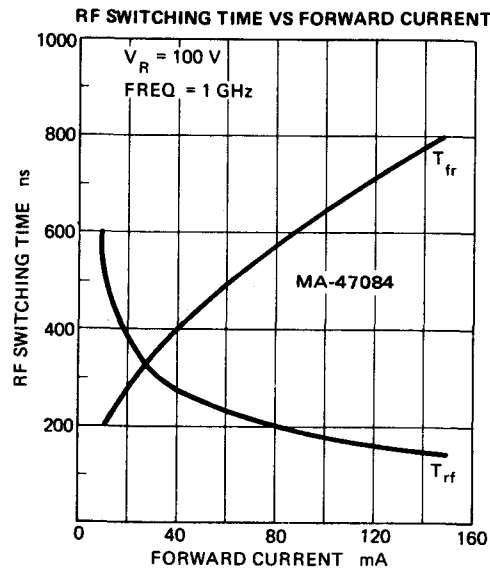

FIGURE 4

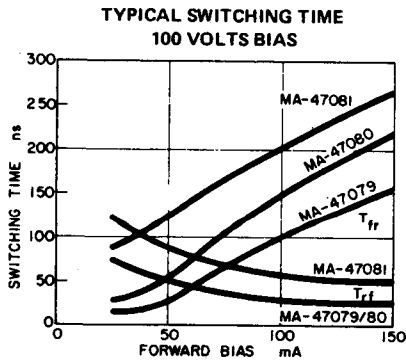

FIGURE 5

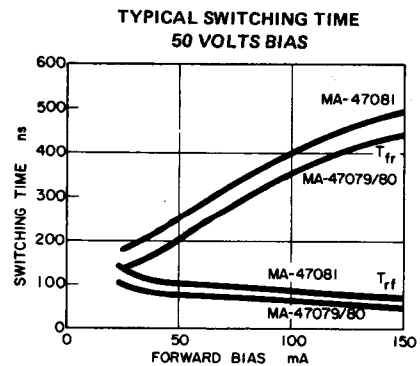

FIGURE 6

TYPICAL PERFORMANCE CURVES (Continued)

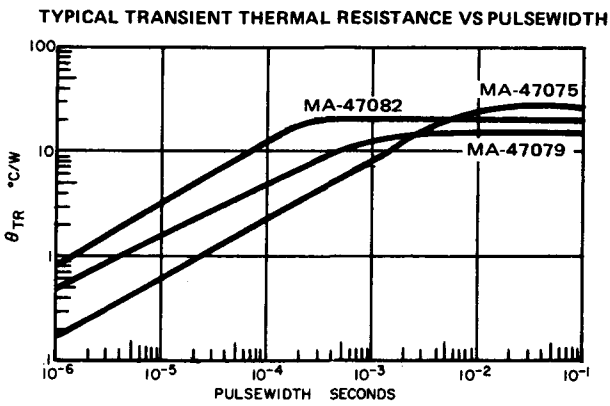

FIGURE 7

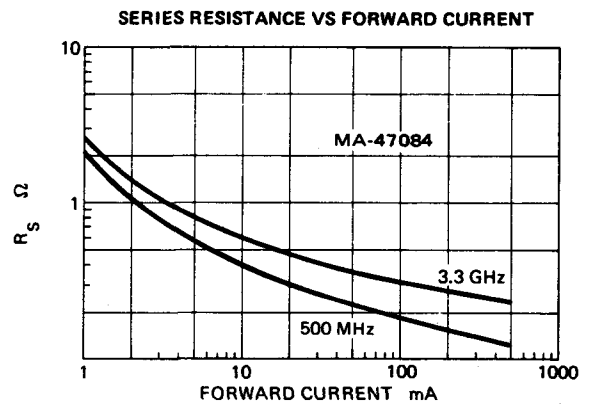

FIGURE 8

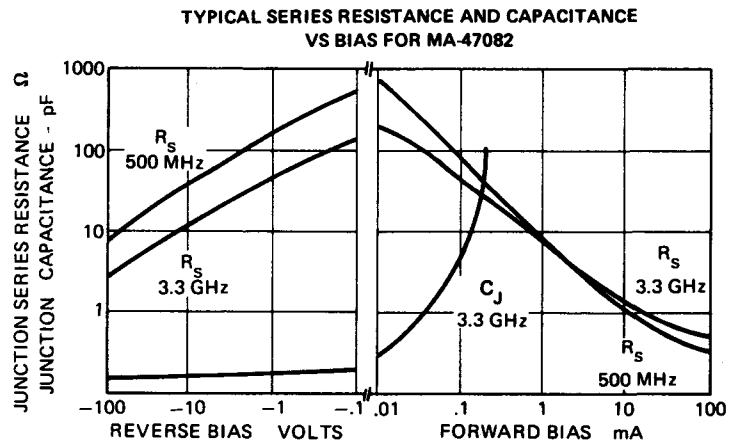

FIGURE 9

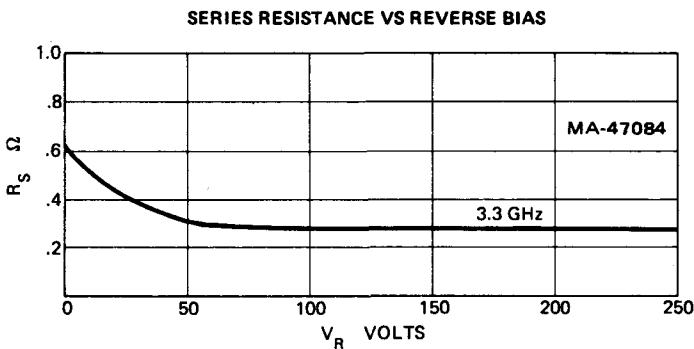

FIGURE 10

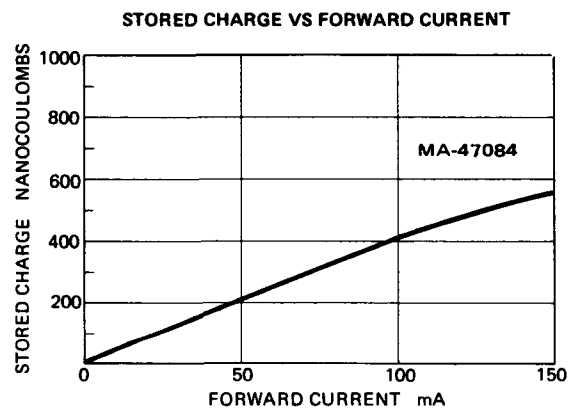

FIGURE 11

High Power Switching Diodes

PIN Chips MA-47400 Series

CASE STYLES

130

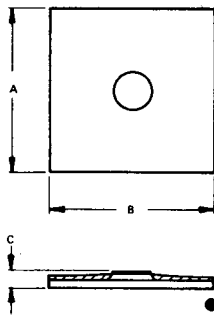

DIM.	INCHES		MM	
	MIN.	MAX.	MIN.	MAX.
A	.075	.095	1.90	2.51
B	.075	.095	1.90	2.51
C	.0085	.0105	0.021	0.026

131

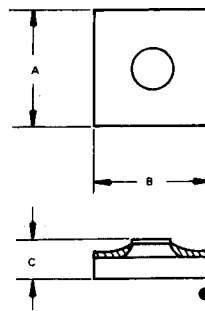

DIM.	INCHES		MM	
	MIN.	MAX.	MIN.	MAX.
A	.030	.035	0.762	0.889
B	.030	.035	0.762	0.889
C	.0085	.0105	0.021	0.026

132

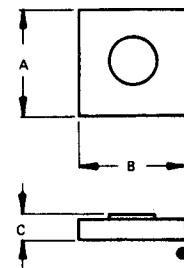

DIM.	INCHES		MM	
	MIN.	MAX.	MIN.	MAX.
A	.020	.024	0.508	0.609
B	.020	.024	0.508	0.609
C	.003	.006	0.076	0.152

NOTE: ● Indicates cathode.

NOT TO SCALE

MAXIMUM RATINGS

$$\text{CW Power Dissipation (Watts) @ } T_{op} = \frac{(175 - T_{op})}{\theta_{JC}}$$

Temperature:

Operating -65 to +175°C
Storage -65 to +200°C

Where: T_{op} = Operating Temperature (°C)
 θ_{JC} = Thermal Resistance (°C/W)

ELECTRICAL CHARACTERISTICS @ $T_A = 25^\circ\text{C}$

Chip Model Number	Chip* Style	Packaged Diode Model	Case Style	Min. ¹ Breakdown Voltage Volts	Capacitance ² pF		Approx. Top Contact Diameter MILS
					Typ.	Max.	
MA-47400	130	MA-47084	109	1000	2.2	3.0	50
MA-47401	131	MA-47075	30	1000	0.15	0.25	8
MA-47402	131	MA-47077	30	1000	0.3	0.55	14
MA-47403	131	MA-47079	30	500	0.15	0.25	7
MA-47404	131	MA-47080	30	500	0.25	0.40	10
MA-47405	132	MA-47082	30	300	0.15	0.25	5

Case Styles 130 and 131 are hermetically sealed CERMACHIP[®] devices.



MICROWAVE ASSOCIATES, INC. BURLINGTON, MASSACHUSETTS

TYPICAL OPERATING CHARACTERISTICS @ $T_A = 25^\circ\text{C}$

Chip Model Number	Max. ³ Series Resistance Ohms	Minority ⁴ Carrier Lifetime μS	Reverse Switching Time - t_{FR} nS	Forward Switching Time - t_{RF} nS
MA-47400	0.3 @ 150 mA	5.0	650	300
MA-47401	0.80 @ 100 mA	3.0	150	150
MA-47402	0.50 @ 100 mA	4.0	350	150
MA-47403	0.60 @ 100 mA	1.5	100	30
MA-47404	0.45 @ 100 mA	1.5	150	30
MA-47405	0.60 @ 50 mA	0.8	75	30

NOTES:

- Breakdown Voltage is measured at $-10 \mu\text{A}$.
- Chip Capacitance is measured at -100 Volts and 1 MHz. Appropriate case capacitance must be added for packaged diode models. ($C_p = .18 \text{ pF}$ for Case Style 30 and $C_p = .75 \text{ pF}$ for Case Style 109)
- Series resistance is measured at 500 MHz.
- Minority carrier lifetime is measured at $I_F = 10 \text{ mA}$ and $I_R = 6 \text{ mA}$.
- Reverse Switching Time (t_{FR}) is measured at $I_F = 100 \text{ mA}$ to $V_R = 100\text{V}$.
- Forward Switching Time (t_{RF}) is measured at $V_R = 100\text{V}$ to $I_F = 100 \text{ mA}$.

APPLICATIONS DATA

TYPICAL SERIES RESISTANCE VS CURRENT
MA-47400 SERIES CHIP DIODES ($f=500 \text{ MHz}$)

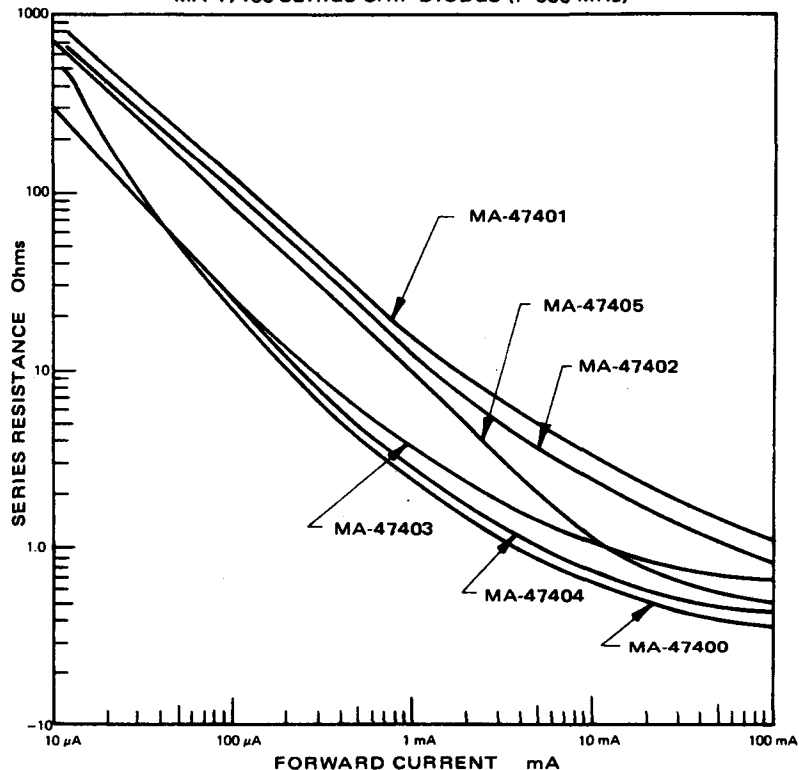

PIN Diodes For Fast Switching And Limiting Applications

Bulletin 4351

CONTROL DIODES

Ceramic Packages

Glass Packages

Chips

FEATURES:

- Switching time typically 5 nS.
- Low Series resistance, typically 1 Ω
- Low bias current requirements
- High power limiting capability, 50W peak pulse power.

DESCRIPTION

This Series of PIN diodes features oxide passivated silicon devices of mesa construction. The devices have been optimized for fast switching and limiting by careful design and precise chip-processing control. Their low series resistance at low bias currents and low minority carrier lifetime provide a low-loss, ultra-fast switching or limiting device. They are available in ceramic packages for medium power fast-switching; in glass packages for lower power fast-switching, and in chip and beam lead form for MIC applications.

APPLICATIONS

Typical applications of these devices include single and multi-throw switches, pulse modulators, duplexers, TR switches and limiters.

Fast Switching PIN Diodes

Ceramic Packages Chips

CASE STYLES

30

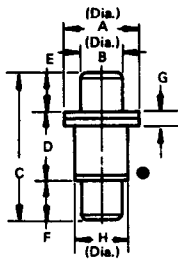

TYPICAL
 $L_p = 0.40 \text{ nH}$
 $C_p = 0.18 \text{ pF}$

DIM.	INCHES		MM	
	MIN.	MAX.	MIN.	MAX.
A	.119	.127	3.02	3.23
B	.080	.084	1.52	1.83
C	.205	.225	5.21	5.72
D	.085	.097	2.16	2.46
E	.080	.084	1.52	1.63
F	.080	.084	1.52	1.63
G	.018	.024	0.41	0.61
H	.079	.083	2.01	2.11

132

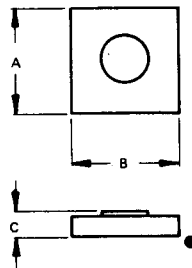

DIM.	INCHES		MM	
	MIN.	MAX.	MIN.	MAX.
A	.020	.024	0.508	0.609
C	.003	.006	0.076	0.152

134

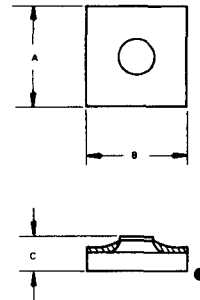

DIM.	INCHES		MM	
	MIN.	MAX.	MIN.	MAX.
A	.0135	.0165	0.3429	0.4191
B	.0135	.0165	0.3429	0.4191
C	.0035	.0065	0.0889	0.1651

Not to scale.

NOTE: ● Denotes Cathode.

ABSOLUTE MAXIMUM RATINGS

Temperature Range:

Operating -65 to +175°C

Storage -65 to +200°C

CW Power Dissipation (Watts) @ $T_{op} = (175 - T_{op})$

θ_{JC}

Where: T_{op} = Operating Temperature (°C)

θ_{JC} = Thermal Resistance (°C/W)

ELECTRICAL CHARACTERISTICS @ $T_A = 25^\circ\text{C}$

Model Number	Case Style	Chip Number	Chip Style	Min. ¹	Max. ²	Max. ⁷	Max.
				Breakdown Voltage Volts	Total Capacitance pF	Series Resist. Ohms	Thermal Resist. °C/W
MA-47052	30	MA-47424	134	200	0.35	1.5	40
MA-47051	30	MA-47408	132	100	0.35	1.0	40

(Continued on next page)



MICROWAVE ASSOCIATES, INC. BURLINGTON, MASSACHUSETTS

TYPICAL CHARACTERISTICS @ T_A = 25°C

Model Number	Chip Model Number	Chip Style	Dynamic ³ Q	Minority ⁶ Carrier Lifetime nS	Power ⁴ Handling kW	Reverse ⁵ Switching Time - t _{FR} nS	Forward ⁵ Switching Time - t _{RF} nS
MA-47052	MA-47424	134	200	300	1.0	5	5
MA-47051	MA-47408	132	300	150	.25	5	5

NOTES:

- Breakdown voltage is measured at -10 μA.
- When ordering chips; Chip Capacitance = Total Capacitance minus package capacitance (C_p).
Capacitance is measured at -10 volts and 1MHz.
- Dynamic Q, is defined as $\frac{1}{2\pi f C_T \sqrt{R_R R_F}}$ where R_R and R_F are reverse and forward bias resistance respectively, and gives information regarding the maximum frequency at which the diodes may be used, and the insertion loss and isolation. Typical values, obtained at f = 1 GHz and -100V and 100mA biases, are given in the table above. All devices were measured at 1 GHz. The bias conditions for MA-47051 and MA-47052 are 10mA and -10V. For

- additional information, see M. E. Hines' "Fundamental Limitations in RF Switching and Phase Shifting Using Semiconductor Diodes". Proc. EEE, 53: 697 (1964).
- The diode is mounted in a 50 Ohm line. Pulsewidth is 1 μS with a low repetition rate, such that average heating effects can be neglected. The frequency is 1 GHz.
 - The speed with which the diodes will switch RF power depends on the shape of the waveform and the bias conditions; t_{fr} is from forward to reverse bias, and t_{rf} is from reverse to forward bias. The MA-47051 and MA-47052 are measured between 10 mA forward and 10V reverse.
 - I_F = 10 mA; I_R = 6 mA.
 - Series resistance is measured at +100 mA and 500 MHz.

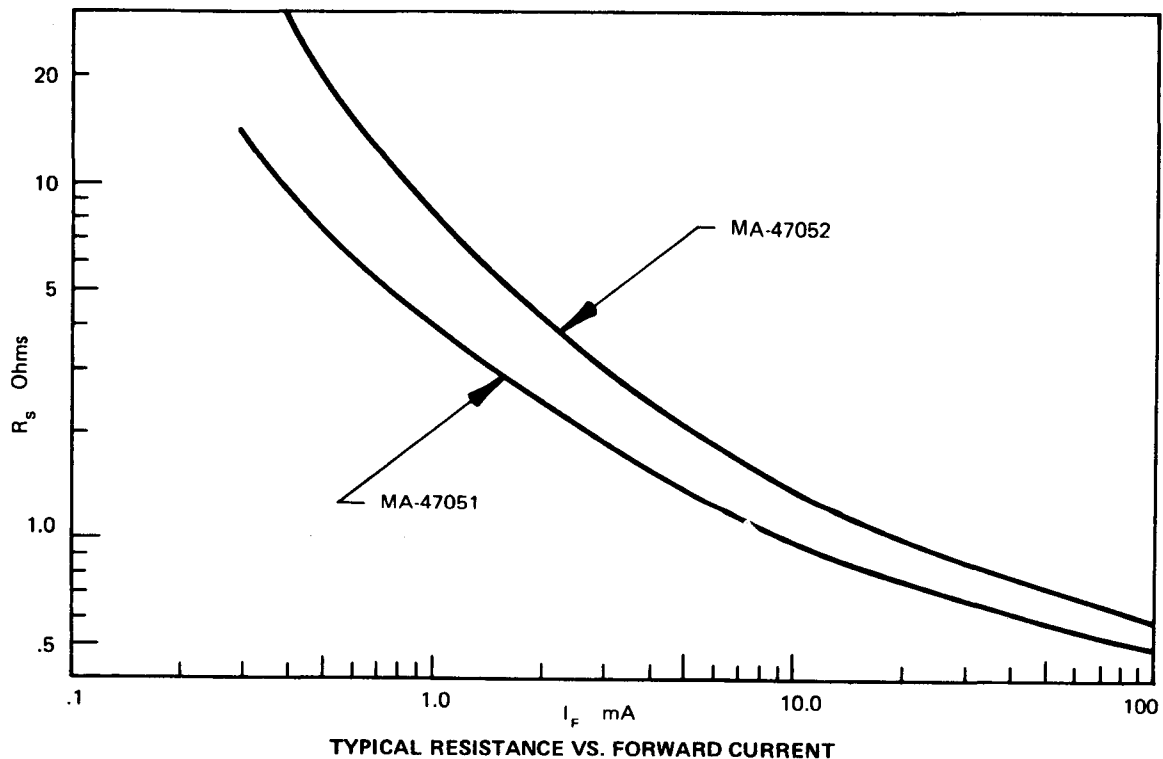

Fast Switching PIN Diodes

Glass Packages and Chips

CASE STYLES 54

132

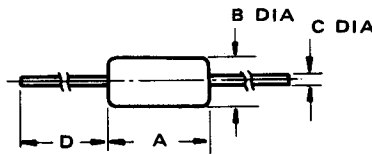

TYPICAL
 $L_p = 1.0 \text{ nH}$
 $C_p = 0.05 \text{ pF}$

DIM.	INCHES		MM	
	MIN.	MAX.	MIN.	MAX.
A	.145	.165	3.68	4.19
B	.068	.075	1.72	1.91
C	.014	.016	0.35	0.41
D	1.000	1.500	25.4	38.1

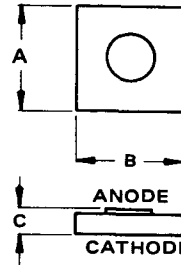

DIM.	INCHES		MM	
	MIN.	MAX.	MIN.	MAX.
A	.020	.024	0.508	0.609
B	.020	.024	0.508	0.609
C	.003	.006	0.076	0.152

Not to scale.

ABSOLUTE MAXIMUM RATINGS @ 25°C

Operating Temperature Range	-65 to +150°C
Storage Temperature Range	-65 to +175°C
Max. Voltage	Breakdown Voltage

Max. D.C. Power Dissipation
at 25°C (Case Style 54) 250mW

FAST SWITCHING DIODES

These fast switching PIN diodes are designed for lower power (up to 250 watts peak/5 watts CW) circuits where nanosecond switching times are required. These diodes are useful from 100 MHz through 18 GHz. All of these PIN diodes are passivated to assure low leakage and high reliability.

Model Number	Case Style	Chip ¹		Min. ²	Max. ³	Max. ⁶	Typ. ⁴	Typ. ⁵
		Model Number	Chip Style	Breakdown Voltage Volts	Total Capacitance pF	Series Resistance Ohms	Minority Carrier Lifetime nS	RF Switching Time nS
MA-47041	54	MA-47427	132	150	0.10	2.5 @ 30mA	75	5
MA-47053	54	MA-47425	132	100	0.20	1.5 @ 10mA	150	5
MA-47054	54	MA-47426	132	100	0.25	1.2 @ 10mA	150	5

NOTES:

- Chip capacitance is equal to $C_T - C_p$.
- $I_R = 10 \mu A$.
- $V_R = 10 V$; $F = 1.0 \text{ MHz}$
- $I_F = 10 \text{ mA}$; $I_R = 6 \text{ mA}$
- $I = 10 \text{ mA}$ to $-10 V$.

6. Series Resistance is measured at 500 MHz.

CONTROL DIODES



MICROWAVE ASSOCIATES, INC. BURLINGTON, MASSACHUSETTS

Fast Switching PIN Diodes

Beam Lead MA-47301, MA-47302

CASE STYLE

129

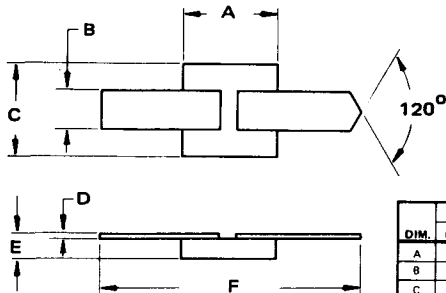

DIM.	INCHES		MM	
	MIN.	MAX.	MIN.	MAX.
A	.007	.011	0.17	0.28
B	.0045	.0055	0.114	0.139
C	.007	.001	0.17	0.28
D	.0004	.0006	0.010	0.015
E	.0020	.0040	0.050	0.101
F	.030	.034	0.76	0.86

MAXIMUM RATINGS @ 25°C

Total Power Dissipation	250 mW
Temperature:	
Operating	-65 to +175°C
Storage	-65 to +200°C

ELECTRICAL SPECIFICATIONS @ 25°C

Model Number	Capacitance ¹ pF		Series ² Resistance Ohms		Breakdown ³ Voltage Volts		Min. ⁴ Forward Current mA	Typ. ⁵ Minority Carrier Lifetime nS	Typ. ⁶ Switching Time - t _{RF} nS
	Typ.	Max.	Typ.	Max.	Min.	Typ.			
MA-47301	.015	0.02	6.0	8.0	40	50	10	100	5
MA-47302	0.03	0.05	4.5	6.0	40	50	10	100	5

NOTES:

1. $V_R = 10$ Volts; $F = 1.0$ MHz
2. $I_F = 10$ mA; $F = 500$ MHz
3. $I_R = 10$ μ A
4. $V_F = 1.0$ Volts
5. $I_F = 10$ mA; $I_R = 6$ mA
6. $V_R = 10$ V; $I_F = 10$ mA



MICROWAVE ASSOCIATES, INC. BURLINGTON, MASSACHUSETTS

APPLICATIONS DATA – FAST SWITCHING BEAM LEAD DIODES

FIGURE 1 TYPICAL FORWARD CONDUCTION CHARACTERISTICS

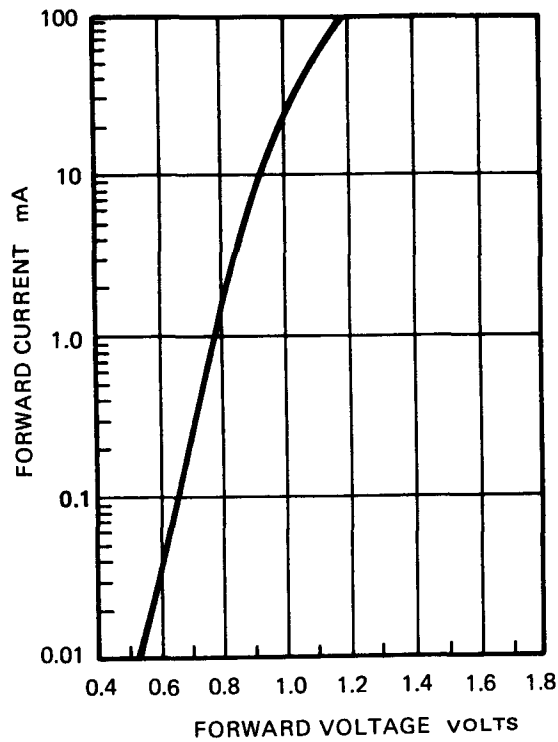
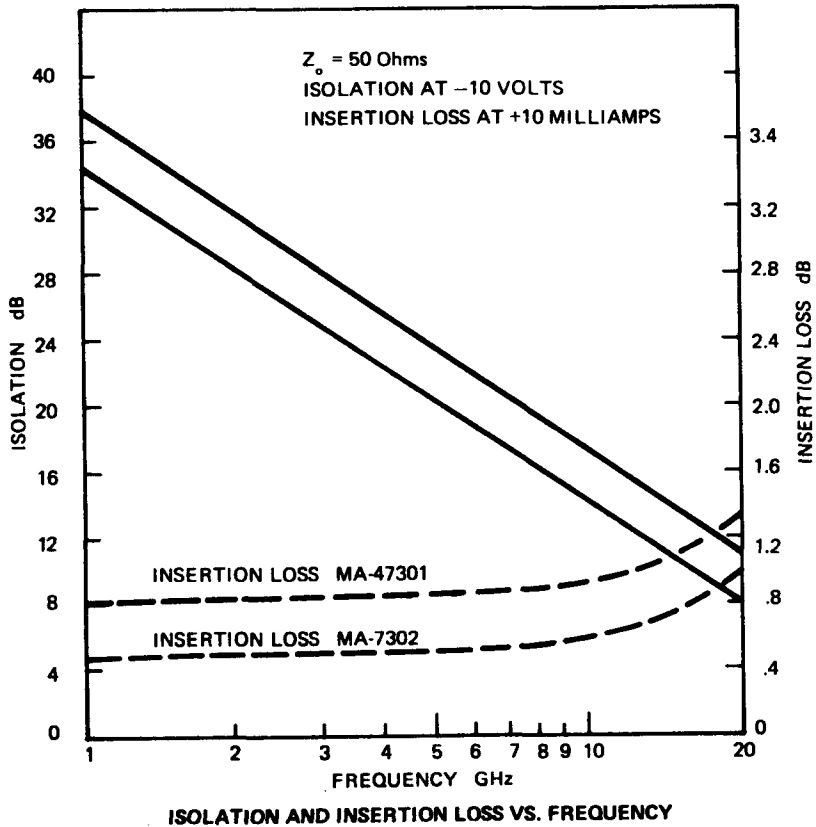

FIGURE 2 TYPICAL ISOLATION AND INSERTION LOSS, MA-47301, MA-47302



All specifications are subject to change without notice.

Limiter PIN Diodes

Ceramic Packages
Glass Packages
Chips

CASE STYLES

30

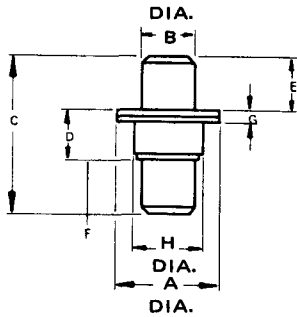

DIM.	INCHES		MM	
	MIN.	MAX.	MIN.	MAX.
A	.119	.127	3.02	3.23
B	.080	.084	1.52	1.63
C	.205	.225	5.21	5.72
D	.085	.097	2.16	2.46
E	.080	.084	1.52	1.63
F	.080	.084	1.52	1.63
G	.018	.024	0.41	0.61
H	.078	.083	2.01	2.11

TYPICAL
 $L_p = 0.4 \text{ nH}$
 $C_p = .18 \text{ pF}$

132

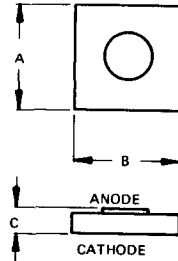

DIM.	INCHES		MM	
	MIN.	MAX.	MIN.	MAX.
A	.020	.024	0.508	0.609
B	.020	.024	0.508	0.609
C	.003	.006	0.076	0.152

54

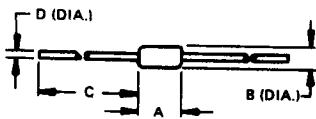

DIM.	INCHES		MM	
	MIN.	MAX.	MIN.	MAX.
A	0.145	0.165	3.70	4.20
B	0.068	0.075	1.727	1.906
C	1.000	1.500	25.4	38.1
D	0.014	0.016	0.366	0.406

TYPICAL
 $L_p = 1.0 \text{ nH}$
 $C_p = .05 \text{ pF}$

134

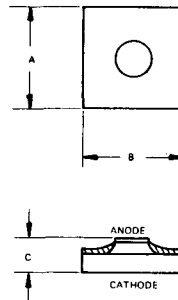

DIM.	INCHES		MM	
	MIN.	MAX.	MIN.	MAX.
A	.0135	.0165	0.3429	0.4191
B	.0135	.0165	0.3429	0.4191
C	.0035	.0065	0.0889	0.1651

Not to scale.

MAXIMUM RATINGS

Temperature Range:

Operating: -65 to +175°C
 Storage: -65 to +200°C

$$\text{CW Power Dissipation (Watts) @ } T_{op} = \frac{(175 - T_{op})}{\theta_{JC}}$$

Where: T_{op} = Operating Temp. (°C)
 θ_{JC} = Thermal Resistance (°C/W)

ELECTRICAL CHARACTERISTICS @ $T_A = 25^\circ\text{C}$

Model Number	Case Style	Chip Model Number	Chip Case Style	Min. ² Breakdown Voltage Volts	Max. ¹ Total Zero Voltage Capacitance pF	Max. ³ Series Resistance Ohms	Max. Thermal Resistance °C/W
MA-47085	30	MA-47410	132	30	0.4	1.5	40
MA-47089	54	MA-47412	132	30	0.3	2.0	500
MA-47091	30	MA-47414	134	30	0.3	2.0	40

NOTES:

1. Chip capacitance is equal to $C_T - C_p$.
2. $I_R = 10 \mu\text{A}$
3. $I_F = 10 \text{ mA}$, $F = 500 \text{ MHz}$



MICROWAVE ASSOCIATES, INC. BURLINGTON, MASSACHUSETTS

APPLICATIONS DATA

FIGURE 1 Ku-BAND PULSE POWER TEST SET

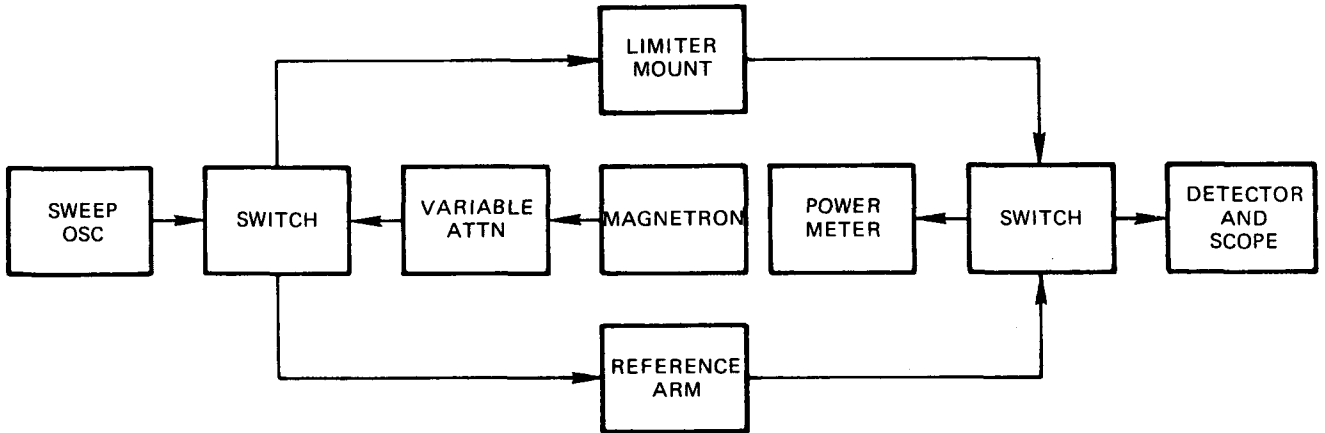
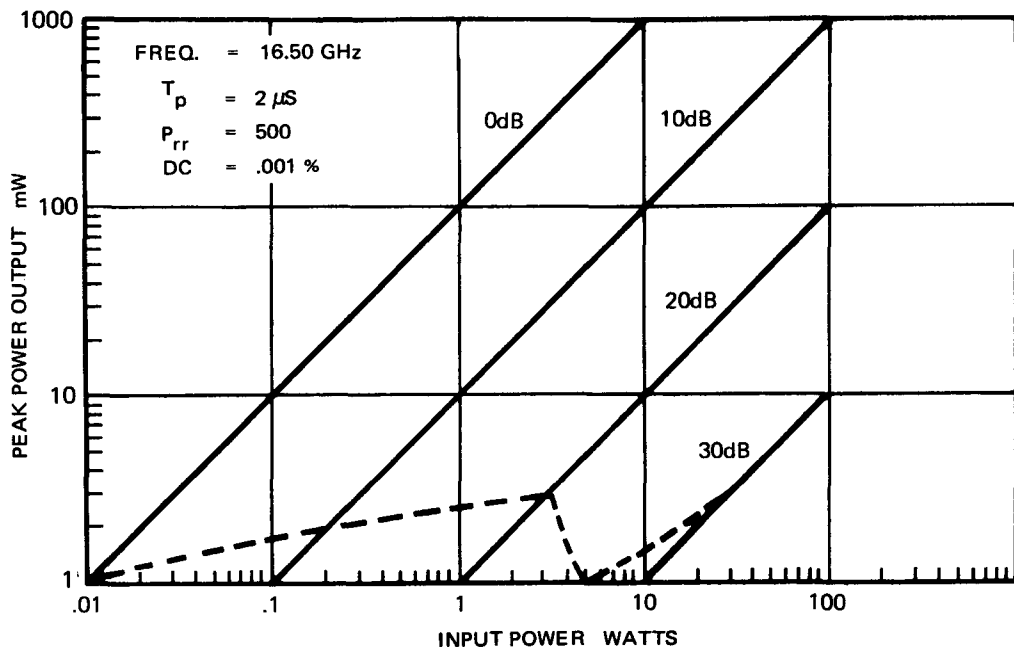

FIGURE 2 MA-47091 TESTED AS A Ku-BAND QUASI-ACTIVE LIMITER USING THE ABOVE TEST SET



IN THE ABOVE GRAPH:

- T_p = Pulse Duration
- P_{rr} = Pulse Repetition Rate
- DC = Duty Cycle

PIN Diodes For General Purpose Switching And Attenuation Applications

Bulletin 4350

CONTROL DIODES

Glass Packages

Chips

FEATURES

- Low Cost
- Reproducible RF characteristics
- Close tracking between units
- High reliability
- Hermetic packaging

DESCRIPTION

This series of diodes was designed specifically for medium and low power control functions. Available in both chip and packaged diode form, these devices were optimized for specific applications by careful design and precise control of chip processing. High reliability and ruggedness are insured by the latest passivation techniques. The hermetically sealed glass package yields the optimum in price versus circuit performance.

APPLICATIONS

PIN diodes are available in this series for the following circuit functions:

- General purpose control diodes (low cost)
- General purpose switching and attenuator diodes
- Precision attenuator diodes
- Very low intermodulation attenuator diodes

General Purpose Switching and Attenuation

Glass Diodes and Chips

CASE STYLES

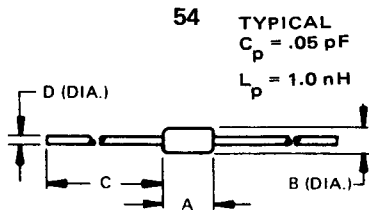

DIM.	INCHES		MM	
	MIN.	MAX.	MIN.	MAX.
A	0.145	0.165	3.7	4.2
B	0.068	0.075	1.727	1.905
C	1.000	1.500	25.4	38.1
D	0.014	0.016	0.356	0.406

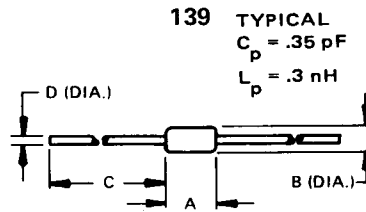

DIM.	INCHES		MM	
	MIN.	MAX.	MIN.	MAX.
A	0.135	0.165	3.43	4.19
B	0.050	0.070	1.27	1.78
C	1.000	1.250	25.4	31.75
D	0.017	0.023	0.432	0.584

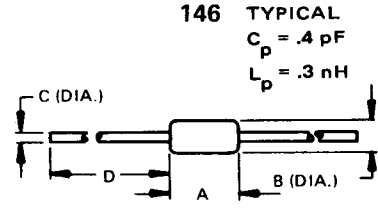

DIM.	INCHES		MM	
	MIN.	MAX.	MIN.	MAX.
A	.200	.240	5.080	6.330
B	.085	.105	2.160	2.670
C	.027	.033	.685	.838
D	1.000	1.250	25.40	31.75

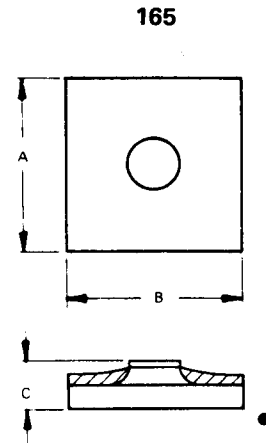
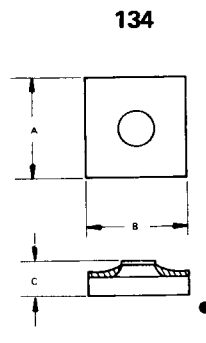
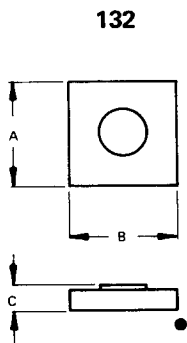

● denotes cathode end.

Not to scale.

ABSOLUTE MAXIMUM RATINGS @ 25° C

Operating Temperature Range
 Storage Temperature Range
 Max. Voltage

-65 to +150°C
 -65 to +175°C
 Breakdown Voltage

CW Power Dissipation

ODS-54-250mW
 ODS-139-400mW
 ODS-146-1 Watt



MICROWAVE ASSOCIATES, INC. BURLINGTON, MASSACHUSETTS

ELECTRICAL SPECIFICATIONS @ $T_A = 25^\circ\text{C}$

LOW COST, LOW SERIES RESISTANCE SWITCHING DIODES

These PIN diodes are intended for low frequency switching from 5 MHz through 1 GHz, where low R_S at small forward current is a prime factor. These diodes are designed for channel switching and switching crystals in UHF and VHF radios, etc.

Model Number	Case Style	Chip ¹ Number	Case Style	Breakdown ² Voltage		Total ³ Capacitance		Max. ⁵ Series Resistance	Typ. ⁶ Minority Carrier Lifetime
				Min. Volts	Typ. Volts	Max. pF	Typ. pF	Ohms	nS
MA-47120	54	MA-47420	134	35	50	1.0	.85	0.5	100
MA-47121	54	MA-47421	134	35	50	2.0	1.2	0.6	100
MA-47122	139	MA-47422	134	35	50	2.0	1.4	0.6	100

LOW COST GENERAL PURPOSE CONTROL DIODES

These PIN diodes are intended for general VHF and UHF switching and in current controlled AGC circuits where purchase price is a prime factor.

Model Number	Case Style	Chip ¹ Number	Chip Style	Breakdown ² Voltage		Series ⁷ Resistance		Total ⁴ Capacitance		Typ. ⁶ Minority Carrier Lifetime	Typ. ⁸ RF Switching Time	
				Min. Volts	Typ. Volts	Max. Ohms	Typ. Ohms	Max. pF	Typ. pF	μS	t_{RF}	t_{FR}
MA-47110	139	MA-47419	132	100	250	3.0	2.5	0.5	0.4	2.0	150	250
MA-47123	139	MA-47423	132	200	250	1.4	1.0	0.5	0.4	1.0	50	200

JAN TX PIN CONTROL DIODES

This unit is intended for general purpose control applications in military systems where a QPL device is required. Full specifications to MIL-S-19500/443 are available on request.

Model Number	Case Style	Min. ² Breakdown Voltage	Max. ⁹ Total Capacitance	Max. ⁷ Series Resistance	Min. ⁶ Minority Carrier Lifetime	Max. ⁷ Forward Voltage	Max. ⁹ Reverse Current
		Volts	Ohms	Ohms	nS	Volts	nA
JAN TX 1N5719	54	150	0.30	1.25	100	1.0	250

NOTES:

- Chip capacitance is equal to total capacitance minus package capacitance (C_p).
- Breakdown Voltage is measured at $-10 \mu\text{A}$.
- Measured at -20 Volts and 1.0 MHz.
- Measured at -50 Volts and 1.0 MHz.
- Measured at $I_F = 10$ mA.
- Minority Carrier Lifetime is measured at $I_F = 10$ mA and $I_R = 6$ mA.
- Measured at $I_F = 100$ mA.
- t_{RF} is measured from -50V to $+50$ mA.
- t_{FR} is measured from $+50$ mA to -50V .
- $V_R = 100$ Volts.

GENERAL PURPOSE SWITCHING AND ATTENUATOR PIN DIODES

These glass PIN diodes are designed for use as general purpose switches or as voltage variable attenuators in the UHF through X-Band range. These diodes all feature oxide passivation.

Model Number	Case Style	Chip ² Number	Chip Style	Min. ¹	Max. ³	Max.	Typ. ⁵	Max. ⁶
				Breakdown Voltage Volts	Total Capacitance pF	Series Resistance Ohms	Minority Carrier Lifetime μ S	Cross Modulation -dB
MA-47100	54	MA-47406	132	100	0.35	10@30mA	2	70
MA-47600	54	MA-47416	132	100	0.35	18@20mA	2	50
MA-47047	54	MA-47418	132	200	0.30	1.5@30mA	1	—

PRECISION ATTENUATOR DIODE

This diode is designed as a precision current controlled resistor for RF Attenuators. It features tightly controlled RF resistance to assure close tracking between units.

Model Number	Case Style	Chip ² Number	Chip Style	Min. ¹	Max. ³	Series Resistance Ohms		Resist. ⁷ vs. Bias Slope		Typ. ⁵	Typ. RF Switching Time ns	
				Breakdown Voltage Volts	Total Capacitance pF	Min.	Max.	Min.	Max.	Minority Carrier Lifetime μ S	t_{fr}	t_{rf}
MA-47083	54	MA-47407	132	300	0.25	690	1040@10 μ A	.86	.90	2.0	200	50
						12	18@1 mA					
						—	1.5@100mA					

LOW COST ATTENUATOR DIODES WITH VERY LOW INTERMODULATION

These diodes are intended for UHF and VHF current controlled AGC circuits, where low intermodulation and low cost are primary factors.

Model Number	Case Style	Chip ² Number	Chip Style	Min. ¹	Total ³	Typ. ⁴	Typ. ⁵	Typ. ⁶
				Breakdown Voltage Volts	Capacitance pF	Series Resistance Ohms	Minority Carrier Lifetime μ S	Cross- and Inter-Modulation -dB
MA-47111	146	MA-47413	165	100	0.8	0.6	3	8
								Refer to Figures 4 & 5.

NOTES:

- Breakdown Voltage is measured at -10μ A.
- Chip capacitance is equal to total capacitance minus package capacitance (C_p).
- $V_R = 50V$; FREQ. = 1.0 MHz
- $I_F = 100$ mA
- $I_F = 10$ mA; $I_R = 6$ mA
- See attached application note.
- $I_F = 10 \mu$ A to 10 mA.
- t_{FR} is measured from +50 mA to -50 Volts.
 t_{RF} is measured from -50 Volts to +50 mA.

APPLICATIONS NOTE INTERMODULATION AND CROSS MODULATION MEASUREMENT

The specified second order intermodulation distortion is measured by using two carriers of equal amplitude at 40 and 50 MHz. The intermodulation products are measured at the sum frequency of 90 MHz. The value is specified as the power below either carrier. Figure 1A.

Cross modulation is a third order distortion product. It is measured by using the same two carriers of equal amplitude. The 40 MHz carrier is 100% modulated. The cross modulation is measured as the power in one side band below the power of the 50 MHz carrier. See Figure 1B.

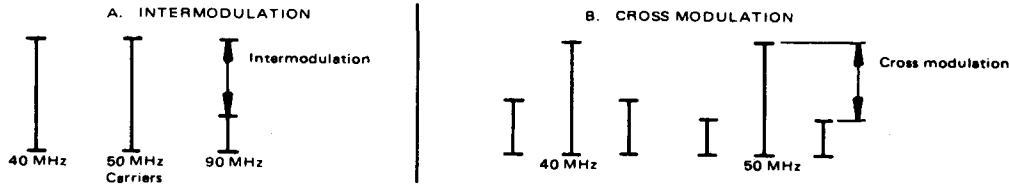

FIGURE 1

Both intermodulation and cross modulation are frequency and power dependent. In general these products will decrease if the frequency is increased and other conditions remain the same. The cross modulation and intermodulation products will also increase rapidly at a single frequency when the carrier power is increased.

All measurements are made in a matched π attenuator, with a line impedance of 50 ohms.

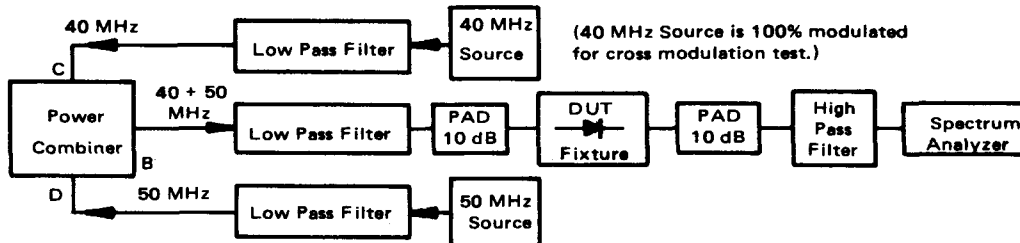

FIGURE 2 INTERMODULATION AND CROSS MODULATION TEST CIRCUIT

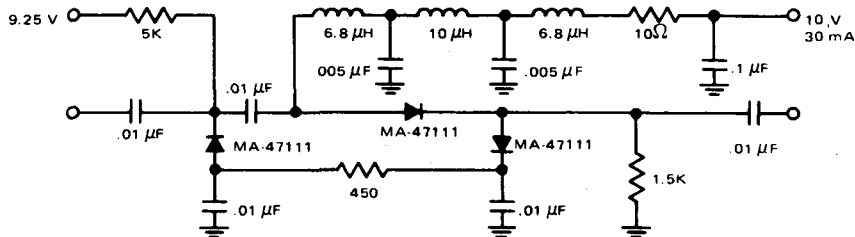

FIGURE 3 MATCHED ATTENUATOR π -CIRCUIT FOR MA-47111, MA-47110

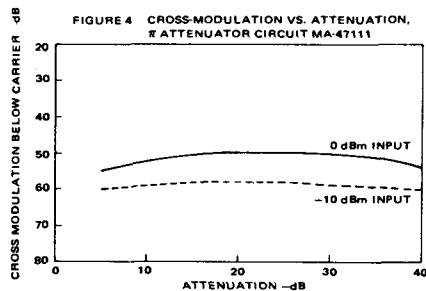

FIGURE 4 CROSS-MODULATION VS. ATTENUATION, π ATTENUATOR CIRCUIT MA-47111

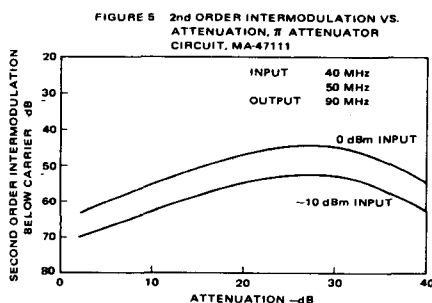

FIGURE 5 2nd ORDER INTERMODULATION VS. ATTENUATION, π ATTENUATOR CIRCUIT, MA-47111

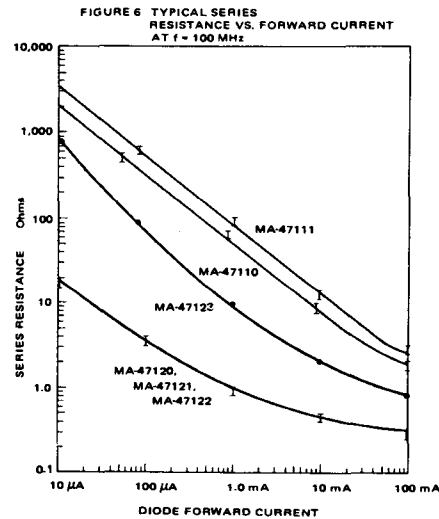

FIGURE 6 TYPICAL SERIES RESISTANCE VS. FORWARD CURRENT AT $f = 100$ MHz

VHF-UHF PIN DIODE TR SWITCH

MA-8334 SERIES

Bulletin 5101

CONTROL DIODES

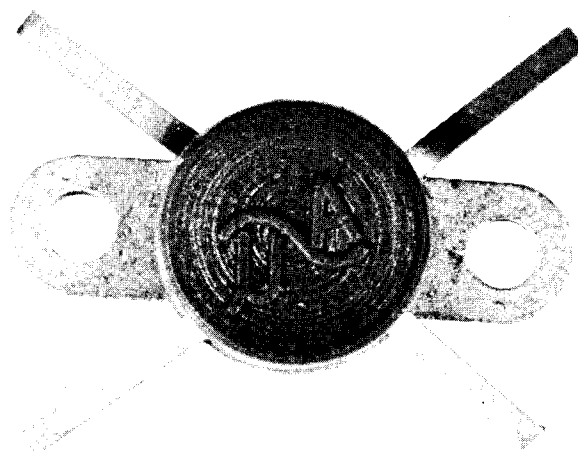

FEATURES

- Frequency range 20 MHz to 1000 MHz
- CW Input Power Rating 50 Watts
- Pulsed Power typically 1 kW, 0.001 duty, 10 μ sec pulses
- Receiver isolation, 28 dB typical at 450 MHz
- Transmit insertion loss, 0.2 dB, typical
- Low intermodulation
- Small modular package
- High reliability solid-state device

APPLICATIONS

- Transmit-receive switch for fixed station, marine, land and airborne mobile communications equipment.
- Space or frequency diversity receiver or transmitter systems
- Controlling of phase shifters for antenna pattern lobing
- CATV distribution switching
- Amateur and citizen band transceivers

DESCRIPTION

This is a hybrid RF circuit which incorporates hermetic hard glass passivated PIN diode chips. The circuit is a single pole double-throw switch for transmit-receive duplexing in mobile and fixed station VHF and UHF communications equipment. Also available as a SP3T switch for other applications. These devices are designed to replace electro-mechanical switching relays used in communications equipment.

Microwave Associates CERMACHIP™ PIN diodes are utilized in these switch circuits. Each CERMACHIP™ diode is hermetic in itself. These switches, therefore, will have high reliability and low reverse leakage, and will withstand extreme electrical and environmental stress. These devices are matched for a nominal 50 ohm line impedance.

Switching is accomplished with a forward direct current for passing arm. The off arm is simply left open-circuit with no bias. Heat sinking is provided through the copper base of the module and circuit frame.

SPECIFICATIONS

Frequency Range:	20 - 500 MHz	
Isolation	Typ.	Spec.
200 MHz	33 dB	28 dB Min.
450 MHz	28 dB	24 dB Min.
Loss	0.2 dB	0.4 dB Max.
Nom. Impedance, all ports	50 ohms	
Input VSWR	1.2	1.4 Max.
Lifetime	1 μsec Min.	
Input Power	50 Watts Typ.	
Bias Required	50 mA*	
Heat Sink Temp.	-55°C to +100°C	
Harmonic Output	Meets standards for Commercial Radio Application when installed in Typical Transmitter Circuitry. Evaluation in final Customer Circuit is recommended.	

*Lower frequencies and/or low harmonic specifications may require use of higher bias currents.

SUGGESTED BIAS CIRCUIT

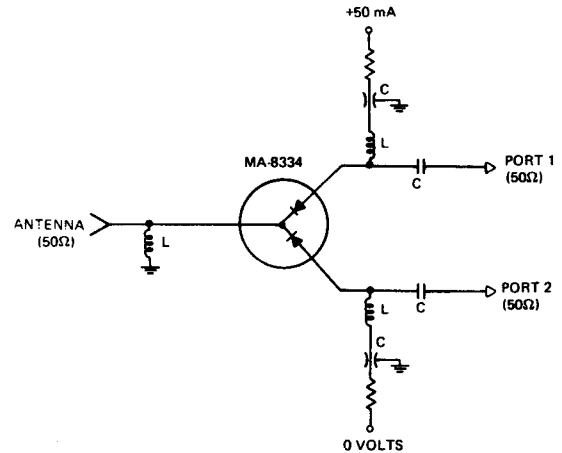

1. All capacitors and inductors should be selected for optimum circuit performance at the design frequency.
2. The series resistors should be selected to provide 50 mA minimum of bias current.
3. Circuit shows bias conditions for low loss between antenna and Port 1 and isolation between antenna and Port 2
4. Reverse polarity switches are available upon request.

TYPICAL PERFORMANCE CURVES

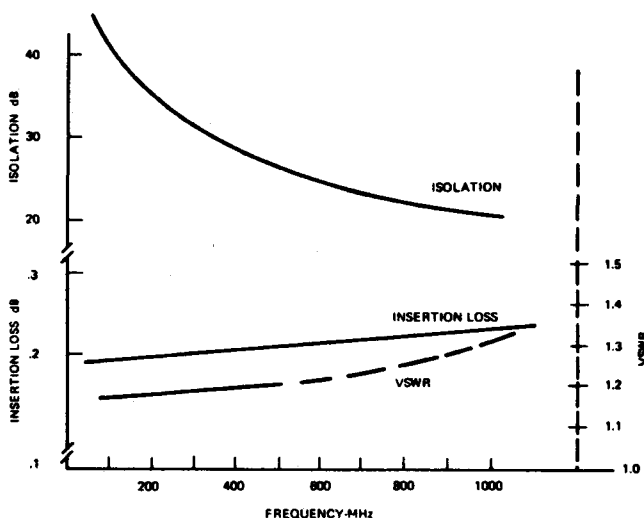

CASE STYLE

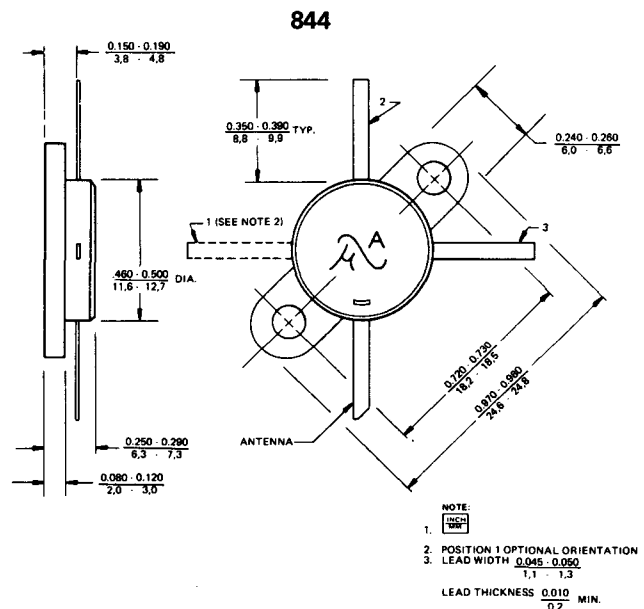

Hermetic Stripline Control Devices

Bulletin 4353

CONTROL DIODES

Broadband PIN Diodes

MA-47200 Series

MA-47220 Series

Microwave Associates, Inc.



FEATURES

- Broadband 50 ohm match through X-band
- Hermetically sealed package
- Low thermal resistance
- High power capability (up to 5 kW peak)
- Fast switching (to 10 ns)

APPLICATIONS

This series of PIN devices is intended for microstrip and stripline control circuits as well as for direct replacement of existing non-hermetic epoxy encapsulated devices. They can function as power switches, limiters, phase-shifters, attenuators, and duplexers. The package flexibility allows the use of high power, high voltage PIN chips that can switch up to 5 kW peak RF power or very fast thin PINs that can switch as fast as 10 nanoseconds.

DESCRIPTION

These broadband matched devices contain a passivated PIN diode chip in shunt; the hermetic seal packaging eliminates the reliability problems associated with earlier devices using epoxy seals. The diodes are matched through X-Band and feature low insertion loss and VSWR characteristics at zero or reverse bias. The designs eliminate the bandwidth limiting parasitics of conventional packages by incorporating the leads and chip as part of a 50 ohm microwave circuit.

Broadband PIN Diodes

MA-47200 Series

MA-47220 Series

CASE STYLES

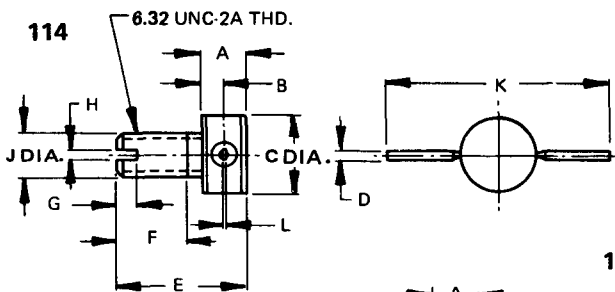

DIM.	INCHES			MM		
	MIN.	NOM.	MAX.	MIN.	NOM.	MAX.
A	—	.133	—	—	3.37	—
B	—	.065	—	—	1.65	—
C	—	—	.242	—	—	6.14
D	.014	—	.016	0.35	—	0.40
E	.380	—	.400	9.65	—	10.16
F	—	.210	—	—	5.33	—
G	—	.060	—	—	1.52	—
H	—	.030	—	—	0.76	—
J	.1312	—	.1372	3.32	—	3.47
K	—	.665	—	—	16.89	—
L	—	.005	—	—	0.012	—

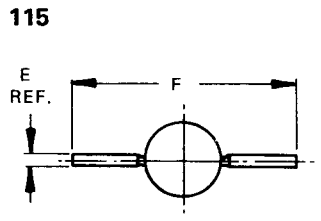
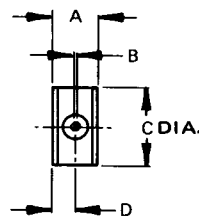

DIM.	INCHES			MM		
	MIN.	NOM.	MAX.	MIN.	NOM.	MAX.
A	—	.133	—	—	3.37	—
B	—	.065	—	—	0.012	—
C	—	—	.242	—	—	6.14
D	—	.065	—	—	1.65	—
E	.014	—	.016	0.35	—	0.40
F	—	.665	—	—	16.89	—

Not to scale.

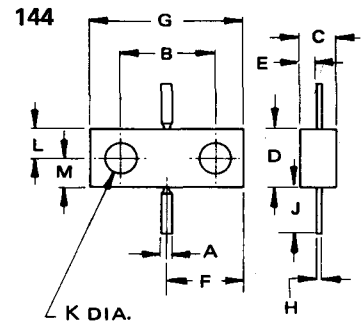

DIM.	INCHES			MM		
	MIN.	TYP.	MAX.	MIN.	TYP.	MAX.
A	—	.030	—	—	0.76	—
B	.242	—	.262	6.15	—	6.65
C	.116	—	.126	2.95	—	3.20
D	.155	—	.165	3.94	—	4.19
E	—	.060	—	—	1.52	—
F	.195	—	.215	4.95	—	5.46
G	.400	—	.420	10.16	—	10.67
H	—	.005	—	—	0.13	—
J	.120	—	—	3.05	—	—
K	.082	—	.100	2.34	—	2.54
L	.075	—	.085	1.91	—	2.16
M	—	.080	—	—	2.03	—

ENVIRONMENTAL RATINGS

Operating and Storage Temperature Range

MA-47200 Series: -65°C to +175°C

MA-47220 Series: -65°C to +150°C

All units are capable of meeting the pertinent requirements of MIL-S-19500.

Max. CW Power Dissipation @ T_{op} =

$$\frac{T_{max} - T_{op}}{\theta} \text{ Watts}$$

where: T_{op} = Operating Temp. (°C)

θ = Thermal Resistance (°C/W)

T_{max} = 175°C for MA-47200 Series

150°C for MA-47220 Series

ENVIRONMENTAL CAPABILITIES PER MIL-STD-750

	Method	Conditions
Moisture Resistance	1021	
Temperature, Storage	1031	-65°C to +150°C
Operating	—	-65°C to +150°C
Cycling	1051	5 cycles, -65°C to +150°C
Thermal Shock	1056	5 cycles, 0°C to +100°C
Shock	2016	5 blows; $X_1, X_2, Y_1, Y_2, Z_1, Z_2$ @ 1500G
Vibration Fatigue	2046	32 hours; X, Y, Z @ 20 G
Vibration,		Four 4-min. cycles; X, Y, Z,
Variable Frequency	2056	@ 20 G Min., 100 to 2000 Hz
Constant Acceleration	2006	20,000 G; $X_1, X_2, Y_1, Y_2, Z_1, Z_2$
Barometric Pressure	1001	150,000 ft.
Salt Atmosphere	1041	



MICROWAVE ASSOCIATES, INC. BURLINGTON, MASSACHUSETTS

ELECTRICAL CHARACTERISTICS @ $T_A = 25^\circ\text{C}$

Model Number	Case Style	Meas. Freq. GHz	Min. ¹ Breakdown Voltage Volts	Max. IL @ -20V dB	Max. VSWR @ -20V	Min. Isolation @ 25 mA dB
MA-47208	114	1.0	1000	0.25	1.5	30
MA-47200	114	1.0	500	0.25	1.5	30
MA-47202	114	6.0	500	0.5	1.5	25
MA-47204	114	8.0	500	0.6	1.5	20
MA-47206	114	10.0	100	0.5 ²	1.5 ²	20 ³
MA-47201	115	1.0	500	0.25	1.5	30
MA-47203	115	6.0	500	0.5	1.5	25
MA-47205	115	10.0	500	0.6	1.5	20
MA-47207	115	10.0	100	0.5 ²	1.5 ²	20 ³
MA-47220	144	10.0	150	0.5	1.5	20 ³
MA-47221	144	Note 4	70	1.0 ²	1.5	20 ³
MA-47222	144	8.0	150	0.5 ²	1.5	20 ³
MA-47223	144	Note 4	500	0.5 ²	1.5	20 ³

TYPICAL OPERATING CHARACTERISTICS

Model Number	Typical Thermal Resist. °C/W	Minority Carrier Lifetime μS	Switching Time		Switching Conditions		Heat Sink
			RF on nS	RF off nS	RF off	RF on	
MA-47208	10	5.0	300	150	100 mA	100V	Cathode
MA-47200	10	2.0	200	60	100 mA	100V	Cathode
MA-47202	15	1.5	150	30	100 mA	100V	Cathode
MA-47204	20	1.5	100	30	100 mA	100V	Cathode
MA-47206	30	0.1	10	10	10 mA	10V	Cathode
MA-47201	10	2.0	200	60	100 mA	100V	Cathode
MA-47203	15	1.5	150	30	100 mA	100V	Cathode
MA-47205	20	1.5	100	30	100 mA	100V	Cathode
MA-47207	30	0.1	10	10	10 mA	10V	Cathode
MA-47220	30	0.5	100	30	100 mA	100V	Anode
MA-47221	20	0.25	10	10	10 mA	10V	Cathode
MA-47222	20	0.5	100	30	100 mA	100V	Cathode
MA-47223	20	2.0	150	30	100 mA	100V	Cathode

NOTES:

- Breakdown voltage is measured at $-10 \mu\text{A}$.
- MA-47206 and MA-47207 measured @ -10V ; MA-47221, MA-47222, and MA-47223 measured at zero volts.
- MA-47206 and MA-47207 measured @ 10 mA; MA-47221 measured at 20 mA; MA-47220, MA-47222, and MA-47223 measured at 100 mA.
- Test frequencies: MA-47221 4-8 GHz (swept)
MA-47223 4-8 GHz (swept)
- Devices properly mounted in sufficient heat sink derate linearly to zero at 150°C .

SUGGESTED SCREENING OF PIN DIODES FOR HIGHER RELIABILITY

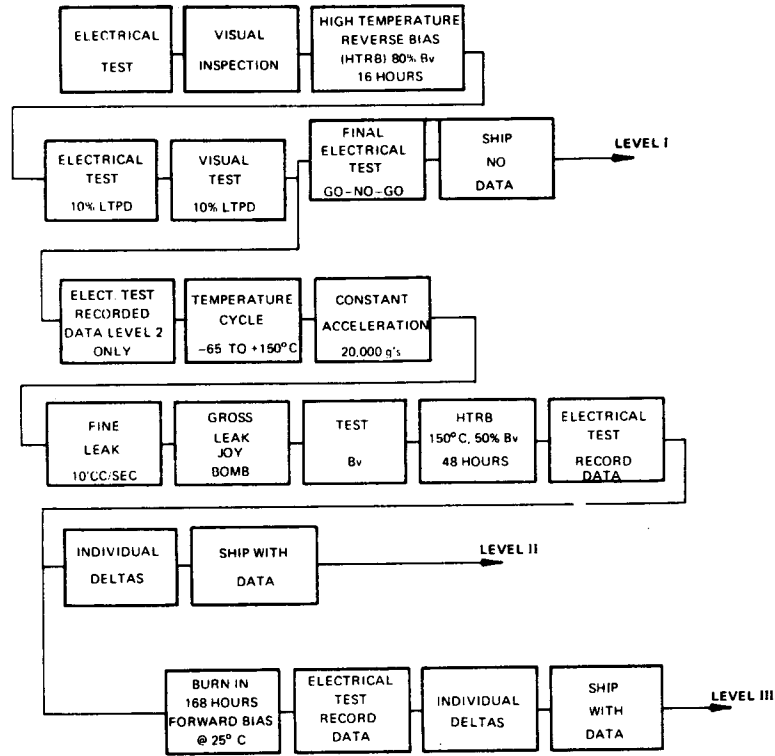

CONTROL DIODES

APPLICATION NOTES

Circuit Diagram

The MA-47200 series of broadband shunt mounted PIN diodes consists of a shunt mounted PIN chip with an appropriate series inductance to produce a matched low pass filter structure at zero or reverse bias. See Fig. 1a and 1b for reverse bias state. By applying +10 to +100 mA to the center conductor the diode's impedance changes to a low impedance inductive short (See Fig. 1c) causing the diode to reflect the RF power. The MA-47220 has an anode heat sink. This diode contains a NIP chip thus it must be biased with 10 to 100 mA to produce high isolation. See Figure 2.

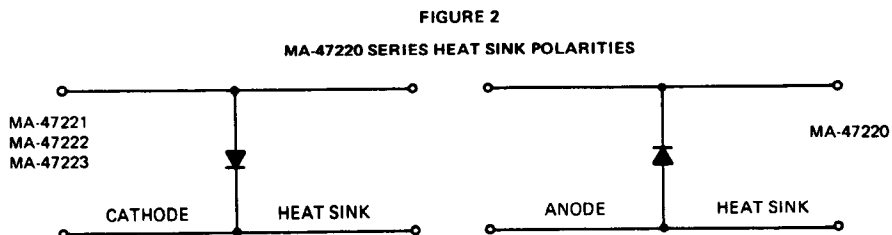
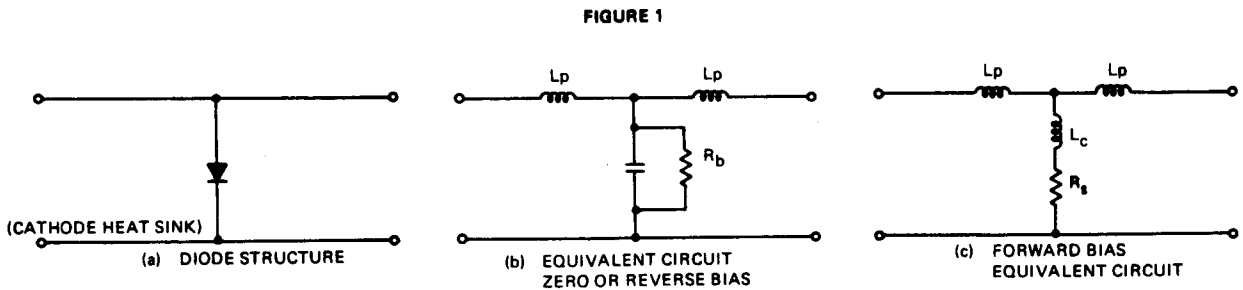

DIODE MOUNTING PROCEDURES

MA-47200 Series; Mounting Procedure and Package Choice

Case Style 114, with threaded stud, is designed for use where the RF power exceeds 1 to 2 watts CW, (or 1 kW peak), and for installations at frequencies above 5 GHz. The stud can be threaded into the ground plane and held down tightly with a nut, producing a low-resistance heat path. (See Figure 3.) A sharp size B (0.238D) drill through the board will produce a tight fit to the package; a 1 or 2 mil metal shim and a thin rubber gasket make an excellent top contact under the cover. The center conductor contact should be 50 ohms in and out. Soldering or parallel gap welding of the leads is suggested to reduce loss.

Case Style 115 is most useful for lower power applications. It is mounted in the same manner as Case Style 114, except that it is not screwed to the ground plane. At frequencies above 5 GHz the 115 case should be secured by soldering to the ground plane.

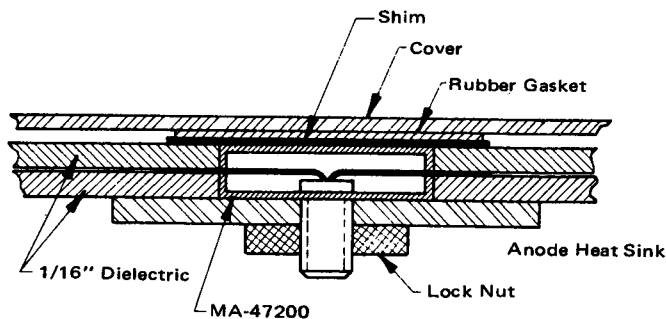

FIGURE 3 MA-47200 MOUNTING IN 1/8" BALANCED STRIPLINE

MA-47220 Series; Mounting Procedure

Case style 144 should be firmly bolted to the ground plate with 6-32 screws through the cover and the mounting holes in the diode case, as shown in Figure 4. Contact with the cover can be improved with a 1 to 2 mil metal shim and a thin rubber gasket. (Poor electrical contact with the cover can result in the excitation of higher order modes.)

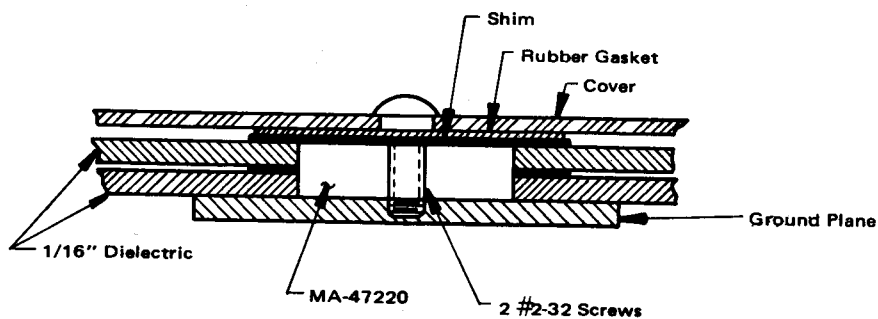

FIGURE 4 MA-47220 MOUNTING IN 1/8" BALANCED STRIPLINE

DC RETURNS

Since the diode is connected in shunt across the transmission line, a dc return must be provided between the center conductor and the ground. This dc return must appear as a high impedance to the RF signal. This can be accomplished in any of the following ways:

1. A $\frac{1}{4}$ wave length shorted transmission can be used. (The impedance of the shorted line should be as high as possible at RF frequencies for good bandwidth.)
2. Commercial bias tees are good dc returns, but in many cases they are narrow band.
3. Lumped filters such as a pi filter may be used.
4. Other circuit elements may be used for dc returns; for instance: center terminals on a circulator or a mixer dc return may be used.

SWITCHING CONDITIONS

Speed

The switching characteristics of these diodes are measured from a 10 to 90% detected RF waveform. The RF off-time is determined by measuring the time for the power to drop 10 dB from its value at the low insertion loss state. The RF on-time is the time for power to rise to approximately 0.5 dB of its low loss value (See Figure 5).

Bias Considerations

The proper bias of the diode can be determined by examining Figure 1a. Bias can be applied to either lead of the diode. A 1 volt and 10 to 100 mA positive current bias is needed for high isolation. Isolation will increase with current (See Figure 7). However, increased bias results in slower switching times. The anode heat sink diode requires the opposite bias.

Fast Switching Considerations

The rise and fall time characteristics of the RF envelope are a function of both the magnitude of the bias current and the shape of the bias pulse. Faster switching may be obtained by reducing the bias current or using bias current waveform shown in Figure 3b. The large initial 2 to 3 ns turn-off current I_{fp} and I_{rp} should be within the limits of the peak bias current (300 to 1000 mA) and maximum power dissipation of the diodes and driver transistors.

A good typical low current driving circuit is shown in Figure 6. The RF block should not affect the rise time characteristics of the drive circuit.

FIGURE 5

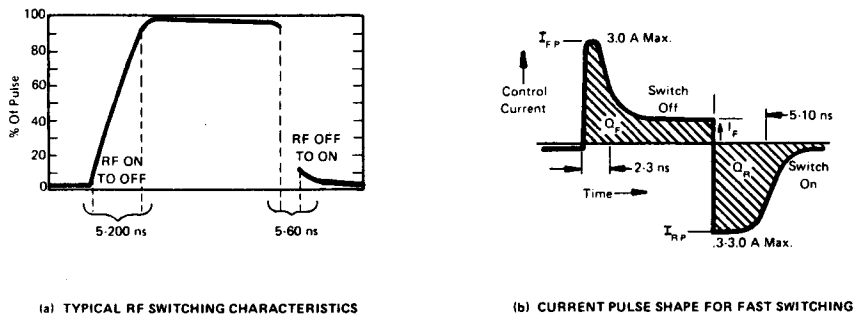
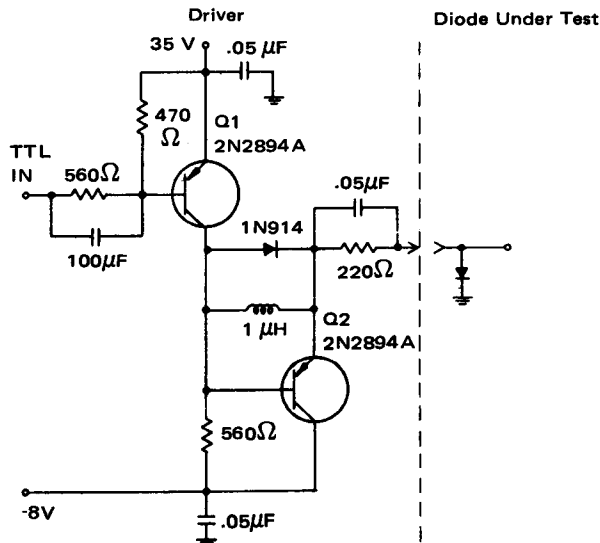

FIGURE 6 TYPICAL HIGH SPEED DRIVER AND DIODE SCHEMATIC



TYPICAL PERFORMANCE CURVES

FIGURE 7 TYPICAL ATTENUATION VS. FORWARD CURRENT MA-47200 AT 1 GHz

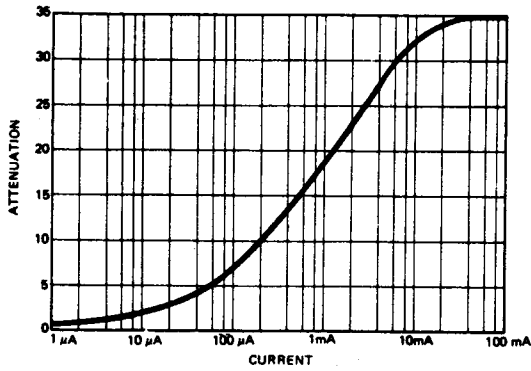

FIGURE 8 TYPICAL ISOLATION AND INSERTION LOSS VS. FREQUENCY OF MA-47207

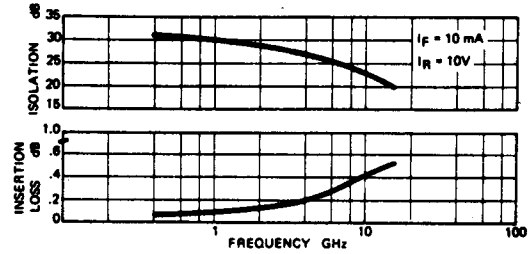

FIGURE 9 TYPICAL VSWR VS. FREQUENCY MA-47220 SERIES

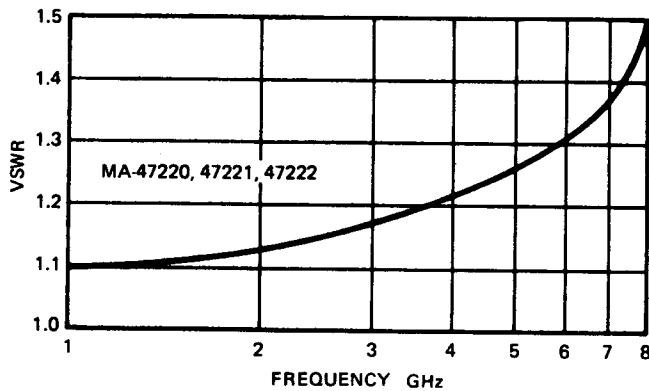

FIGURE 10 MA-47220 SERIES TYPICAL ISOLATION VS. CURRENT AT f = 10 GHz

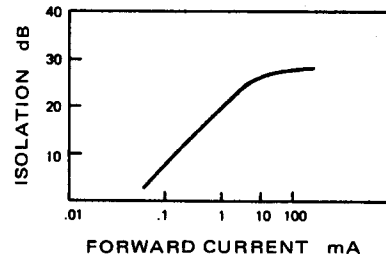

FIGURE 11 TYPICAL INSERTION LOSS VS. FREQUENCY MA-47220 SERIES

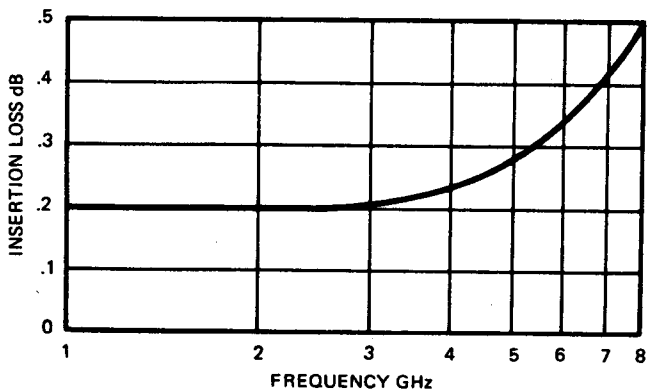
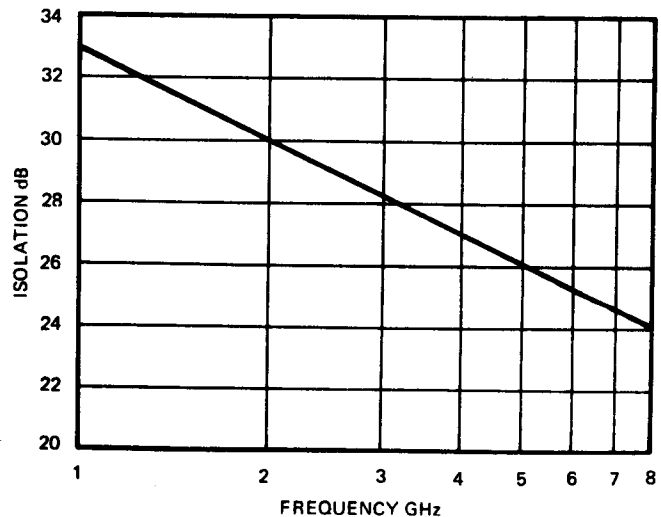

FIGURE 12 TYPICAL ISOLATION VS. FREQUENCY MA-47220 SERIES



Additional PIN Diodes

ELECTRICAL CHARACTERISTICS @ $T_A = 25^\circ\text{C}$

Type Number	Case Style	Min. ¹ Breakdown Voltage Volts	Max. ² Capacitance pF	Max. Series Resistance Ohms	Comments
MA-47407	132	200	.15 ²	1.0	chip; @ 100 mA
MA-47066	54	150	.30 ²	1.5	@ 30 mA
1N5767	54	100	.40 ²	2.5	@ 100 mA
MA-47409	133	100	.15 ²	1.5	chip (NIP)
MA-47086	30	80	.40 ²	1.5	limiter
MA-47090	54	80	.30 ²	1.8	limiter
MA-47411	132	80	.20 ²	1.5	limiter chip
MA-47088	30	30	.40 ²	1.8	
MA-47890	Note 5	1800	3.0	0.2	Note 4
MA-47891	Note 6	1200	2.0	0.3	Note 4
MA-47892	Note 6	1200	1.0	0.4	Note 4
MA-47893	Note 7	1200	.20	0.8	Note 4
MA-47894	Note 7	1200	.10	1.0	Note 4
MA-47895	Note 8	600	.70	0.4	Note 4
MA-47896	Note 9	600	.20	0.7	Note 4
MA-47897	Note 9	600	.10	1.0	Note 4
MA-47898	Note 9	300	.20	0.9	Note 4
MA-47899	Note 9	300	.10	1.0	Note 4

NOTES:

1. Breakdown Voltage is measured at $-10 \mu\text{A}$.
2. Capacitance is measured at -20 Volts.
3. Junction capacitance - measured with sufficient bias to deplete the I Region.
4. The complete model number includes a suffix that describes the case style.
5. Available in Case Styles 131 and 150.
6. Available in Case Styles 131, 109 and 150.
7. Available in Case Styles 131, 30 and 109.
8. Available in Case Styles 131, 30, 54 and 109.
9. Available in Case Styles 131, 30 and 54.

(Continued on following page.)



MICROWAVE ASSOCIATES, INC. BURLINGTON, MASSACHUSETTS

CASE STYLES

30

TYPICAL

$$L_p = .18 \text{ nH}$$

$$C_p = .18 \text{ pF}$$

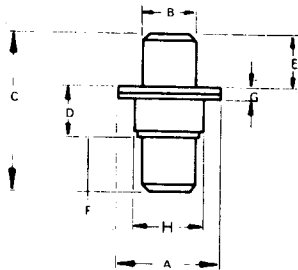

DIM.	INCHES		MM	
	MIN.	MAX.	MIN.	MAX.
A	.119	.127	3.02	3.23
B	.060	.064	1.52	1.63
C	.205	.225	5.21	5.72
D	.085	.097	2.16	2.46
E	.060	.064	1.52	1.63
F	.060	.064	1.52	1.63
G	.016	.024	0.41	0.61
H	.079	.083	2.01	2.11

54

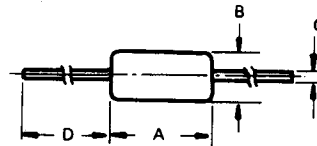

TYPICAL

$$L_p = 2.5 \text{ nH}$$

$$C_p = .05 \text{ pF}$$

DIM.	INCHES		MM	
	MIN.	MAX.	MIN.	MAX.
A	.145	.165	3.68	4.19
B	.068	.075	1.72	1.91
C	.014	.016	0.35	0.41
D	1.000	1.500	25.4	38.1

109

TYPICAL

$$L_p = .60 \text{ nH}$$

$$C_p = .75 \text{ pF}$$

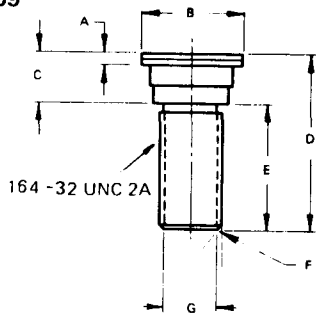

DIM.	INCHES		MM	
	MIN.	MAX.	MIN.	MAX.
A	0.027	0.033	0.69	0.84
B	0.259	0.267	6.6	6.8
C	0.118	0.134	3.0	3.4
D	-	0.446	-	11.35
E	0.317	0.323	8.05	8.25
F	40°	50°	-	-
G	0.110	0.130	2.794	3.302

131

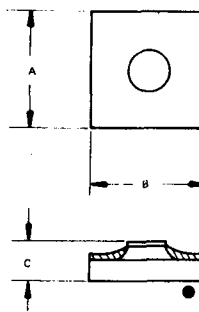

DIM.	INCHES		MM	
	MIN.	MAX.	MIN.	MAX.
A	.030	.035	0.762	0.889
B	.030	.035	0.762	0.889
C	.0085	.0105	0.021	0.026

132

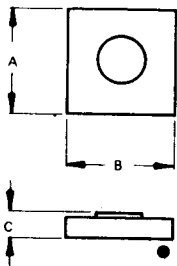

DIM.	INCHES		MM	
	MIN.	MAX.	MIN.	MAX.
A	.020	.024	0.508	0.609
B	.020	.024	0.508	0.609
C	.003	.006	0.076	0.152

133

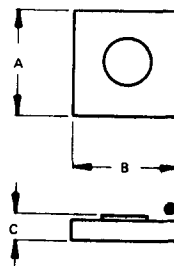

DIM.	INCHES		MM	
	MIN.	MAX.	MIN.	MAX.
A	.020	.024	0.508	0.609
B	.020	.024	0.508	0.609
C	.003	.006	0.076	0.152

150

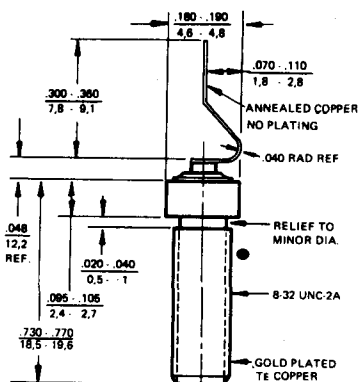

TYPICAL

$$L_p = .80 \text{ nH}$$

$$C_p = .04 \text{ pF}$$

Not to scale.

NOTE: ● Denotes Cathode End.

All specifications are subject to change without notice.

Broadband Power Control Modules

Bulletin 5150

CONTROL DIODES

Broadband PIN Attenuators – MA-8342 Series

Broadband SPST Switches – MA-8343 Series

Broadband SPDT Switches – MA-8345 Series



DESCRIPTION

MA-8342, MA-8343, and MA-8345 broadband modules are designed for broadband applications in stripline and coaxial circuitry. These solid state devices are fabricated with PIN diode chips, integrated into a hermetically sealed 50 ohm structure. This eliminates the circuit parasitics associated with more conventional devices (and their interconnections), allowing improved broadband performance. All internal contacts are welded or thermal compression bonded to guarantee reliable operation. These modules meet the full requirements of MIL-E-5400.

Broadband Module Attenuators

MA-8342 Series

CASE STYLES

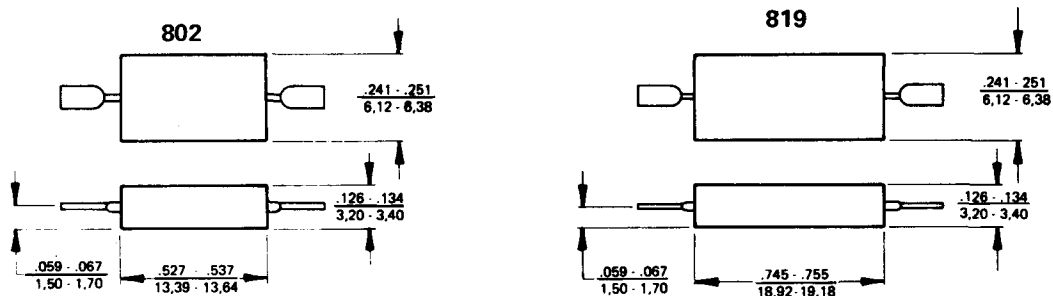

NOTES:

1. Material is kovar or copper with gold plating.
2. The housing is fabricated with glass to metal hermetic seals.
3. $\frac{\text{INCH}}{\text{MM}}$

ELECTRICAL CHARACTERISTICS @ $T_A = 25^\circ\text{C}$

Module Model Number	Case Style	Frequency Range GHz	Max. Current Rating ⁴ mA	Max. Loss at OV Bias dB	Max. VSWR at OV Bias	Mid-Band Attenuation (dB) at Specified Bias Current			
						0.2 mA	0.5 mA	2.0 mA	10 mA
MA-8342-0006	819	2-4	600	1.7	2.0	13-17	25-30	50-56	70 min.
MA-8342-0008	819	4-8	600	2.0	2.25	9-13	19-25	42-48	65 min.
MA-8342-0005	802	8-18	600	2.5	2.0	11-15	22-28	46-52	60 min.

NOTES:

1. All devices exhibit a breakdown voltage in excess of 50 volts.
2. Switching speed: 40 nsec, max (10% - 90% RF waveform)
3. The attenuation as a function of bias current is specified at the mid-band frequency. Typical performance is shown.
4. The maximum total current rating includes the combined RF, CW, and DC bias currents.
5. The attenuation at a specified bias level will vary less than $\pm 10\%$ of the mid-band attenuation over the frequency range. Typical performance is shown.
6. Alternate attenuation current available on request.
7. Special designs available on request.



MICROWAVE ASSOCIATES, INC. BURLINGTON, MASSACHUSETTS

TYPICAL PERFORMANCE CURVES

FIGURE 1 MA-8342-0005 ATTENUATION VS. BIAS CURRENT

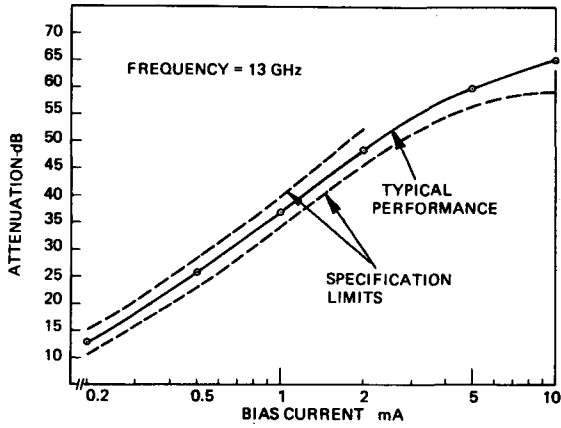

FIGURE 2 MA-8342-0005 ATTENUATION FLATNESS

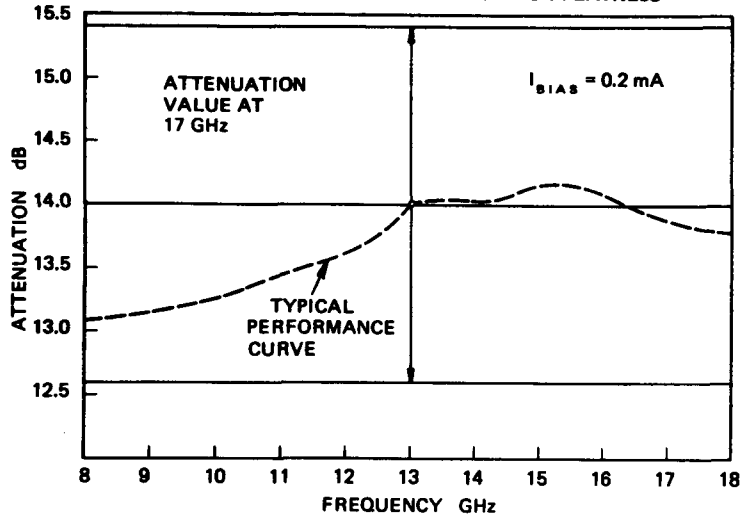

FIGURE 3 MA-8342-0006 ATTENUATION VS. BIAS CURRENT

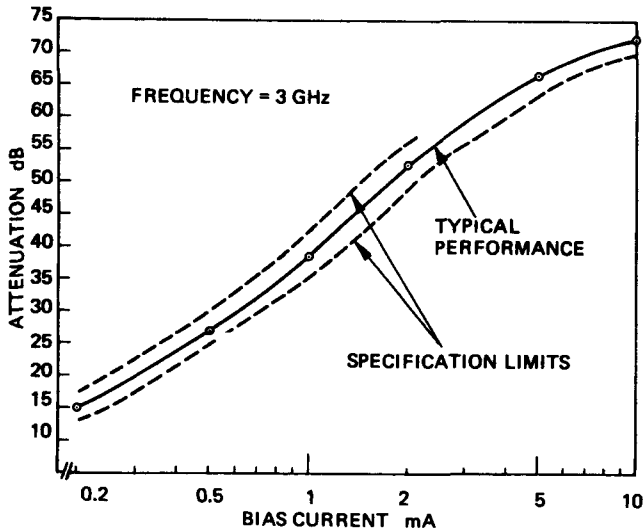
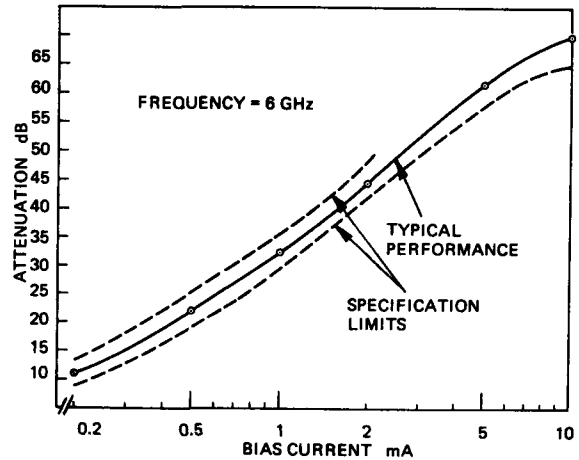

FIGURE 4 MA-8342-0008 ATTENUATION VS. BIAS CURRENT



APPLICATION NOTES

Switching Requirements

Bias normally applied externally to the module attenuator. The module can be supplied with a DC blocking capacitor at one end. This can be obtained by adding the suffix 005 to the part number.

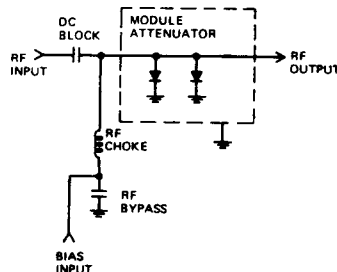

TYPICAL BIAS CIRCUITRY

The attenuator is in the low loss state upon the application of zero or negative bias. Positive bias current is required for attenuation, with attenuation increasing with current. However, it should be noted that excessively high bias current results in slower switching time.

Broadband Module Switches

SPST Switch MA-8343

CASE STYLES

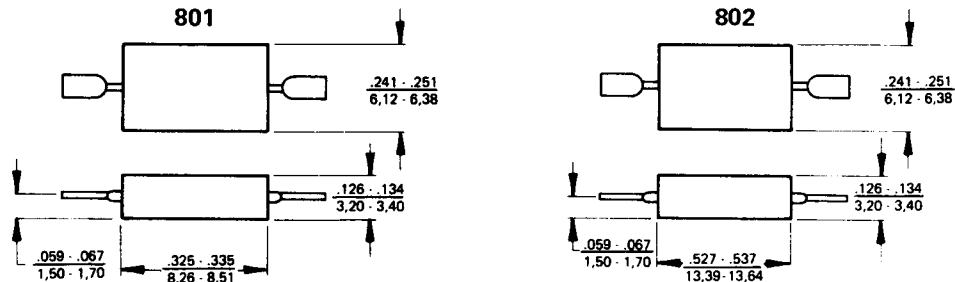

NOTES:

1. Material is kovar or copper with gold plating.
2. The housing is fabricated with glass to metal hermetic seal.

3. $\frac{\text{INCH}}{\text{MM}}$

Not to scale.

ELECTRICAL CHARACTERISTICS @ $T_A = 25^\circ\text{C}$

Module Model Number	Case Style	Max. Current Rating ³ mA	Parameter	Test Frequency, GHz						Bias Conditions
				0.5-1	1-2	2-4	4-8	8-12	12-18	
MA-8343-0001	801	200	Max. Loss, dB	0.4	0.4	0.5	0.6	0.9	1.0	-10V
			Max. VSWR	1.2	1.3	1.3	1.5	1.7	1.9	-10V
			Min. Isolation, dB	20	20	20	20	20	20	+20mA
MA-8343-0005	802	600	Max. Loss, dB	0.5	0.7	1.0	1.5	2.0	2.75	0V
			Max. VSWR	1.2	1.3	1.5	1.5	1.75	2.0	0V
			Min. Isolation, dB	35	55	60	65	65	60	+30mA
MA-8343-0006	802	600	Max. Loss, dB	0.5	0.7	1.0	1.5	2.0	2.75	+6V
			Max. VSWR	1.2	1.3	1.5	1.5	1.75	2.0	+6V
			Min. Isolation, dB	35	55	60	65	65	60	-30mA

NOTES:

1. All devices exhibit breakdown voltage in excess of 50 volts.
2. Switching Speed: 40 nsec, max. (10% - 90% RF waveform)
3. The maximum total current rating includes the combined RF, CW, and DC bias currents.
4. Special designs available on request.

TYPICAL PERFORMANCE CURVES, MA-8343-0005

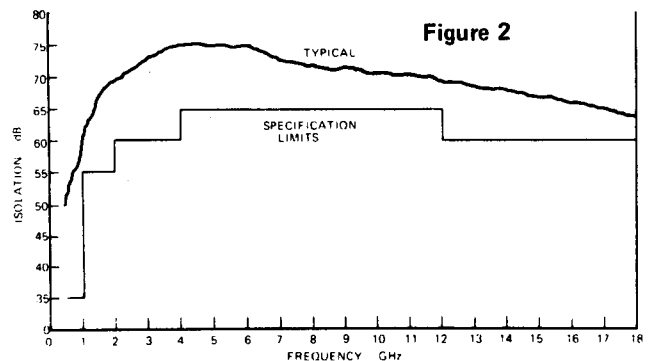
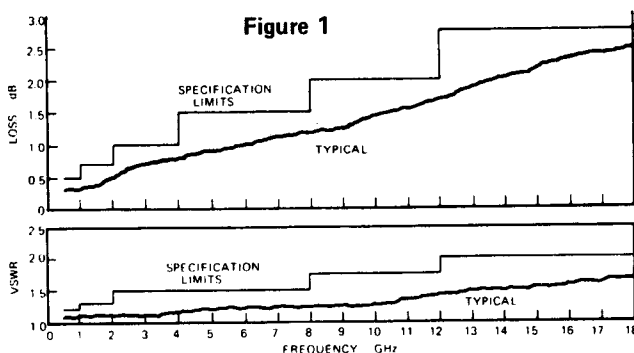

MICROWAVE ASSOCIATES, INC. BURLINGTON, MASSACHUSETTS

APPLICATION NOTES

Switching Requirements

Bias is normally applied externally to the module switch. The module can be supplied with a DC blocking capacitor at one end. This can be obtained by adding the suffix -005 to the part number.

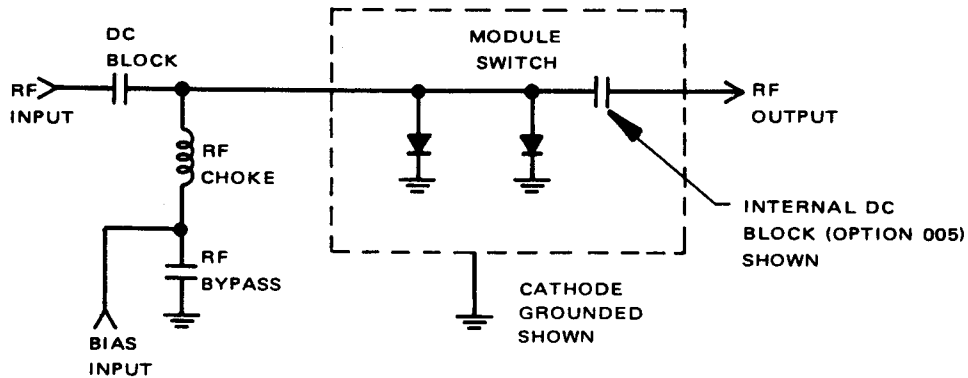

FIGURE 1 TYPICAL BIAS CIRCUITRY

The switch is in the low loss state upon the application of zero or negative bias. Positive bias current is required for isolation with attenuation increasing with current. However, it should be noted that excessively high bias current results in slower switching time.

Power Handling Capability

The power handling capability of the switches are dependent on the pulse length, duty cycle, attenuation condition, voltage rating of the diodes and the bias applied.

The maximum applied reverse voltage (combination of the peak RF voltage and DC bias) should not exceed the breakdown voltage.

Maximum power can be handled using the switches full on or off. The power rating is reduced, should the switch be biased to an attenuation level in between. High isolation switches typically reach minimum power handling at an attenuation level ≈ 10 dB. The derating curve is shown in Figure 3.

Power handling must be derated with temperature, and is shown in Figure 4

FIGURE 3 POWER HANDLING CAPABILITY VS. ATTENUATION

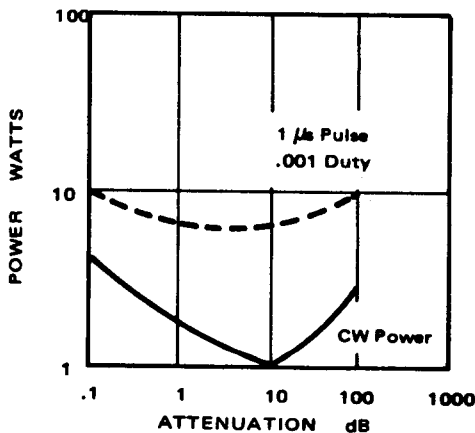
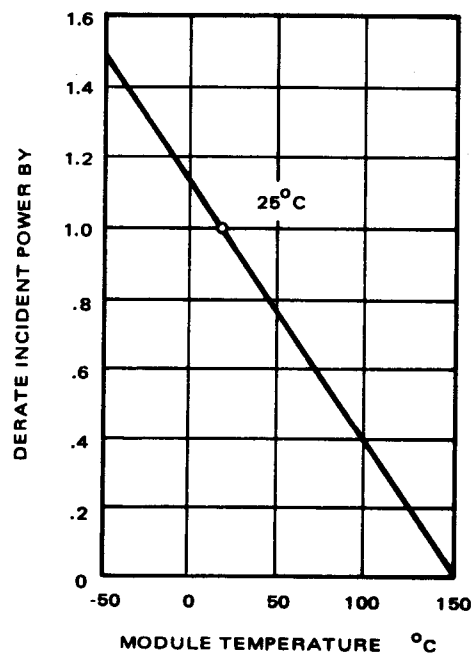

FIGURE 4 INCIDENT POWER DERATING CURVE VS. CASE TEMPERATURE REFERENCED TO °C



Broadband Module Switches

SPDT MA-8345 Series

CASE STYLE 806

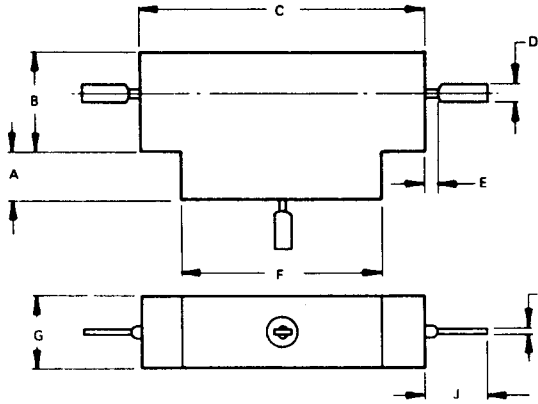

DIM.	DIMENSIONS					
	INCHES			MM		
	MIN.	TYP.	MAX.	MIN.	TYP.	MAX.
A	.047	.052	.057	1.2	1.3	1.4
B	.241	.246	.251	6.1	6.2	6.4
C	.552	.557	.562	14	14.1	14.3
D	—	—	.045	—	—	1.1
E	—	—	.015	—	—	0.4
F	.241	.246	.251	6.1	6.2	6.4
G	.125	.130	.135	3.2	3.3	3.4
H	.002	.006	.010	0.1	0.2	0.3
J	.050	—	.100	1.2	—	2.5

NOTES:

1. Material is kovar or copper with gold plating.
2. The housing is fabricated with glass to metal hermetic seals.

Not to scale.

ELECTRICAL CHARACTERISTICS @ $T_A = 25^\circ\text{C}$

Model Number	Maximum Loss at -30 mA dB					Minimum Isolation at +30 mA dB					Maximum VSWR at -30 mA				
	Frequency GHz					Frequency GHz					Frequency GHz				
	1-2	2-4	4-8	8-12	12-18	1-2	2-4	4-8	8-12	12-18	1-2	2-4	4-8	8-12	12-18
MA-8345-0001	2.0					70					2.0				
MA-8345-0002	0.7	0.8	1.3	1.5		45	45	45	45		1.5	1.75	1.75	2.0	
MA-8345-0003	0.7	1.0	1.3	2.0	2.5	60	55	50	45	35	1.5	1.75	1.75	2.0	2.0

Switching Speed: 300 nsec. max.
Power Rating: 250 mW max. C. W.

TYPICAL PERFORMANCE CURVES MA-8345-0003

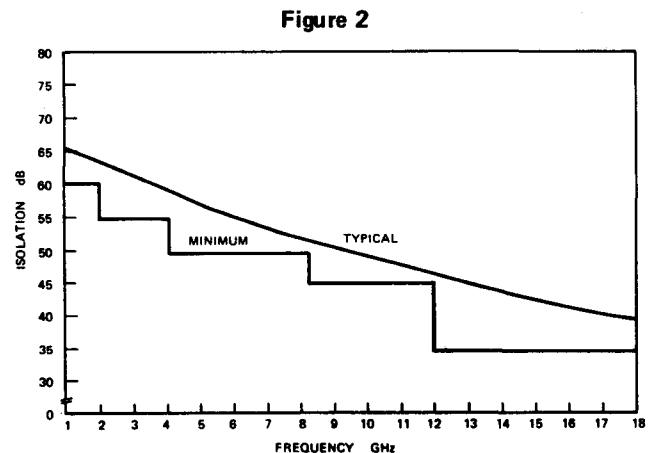
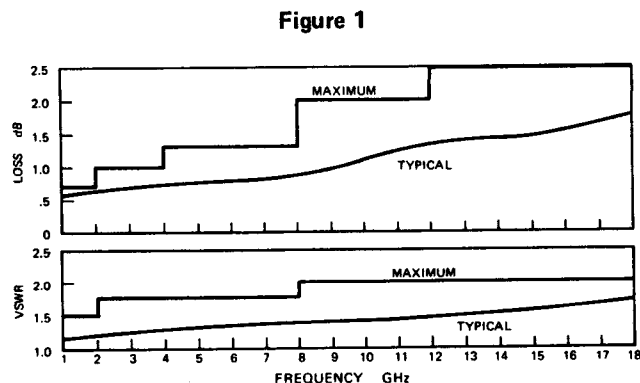

APPLICATION NOTES:
Switching Requirements

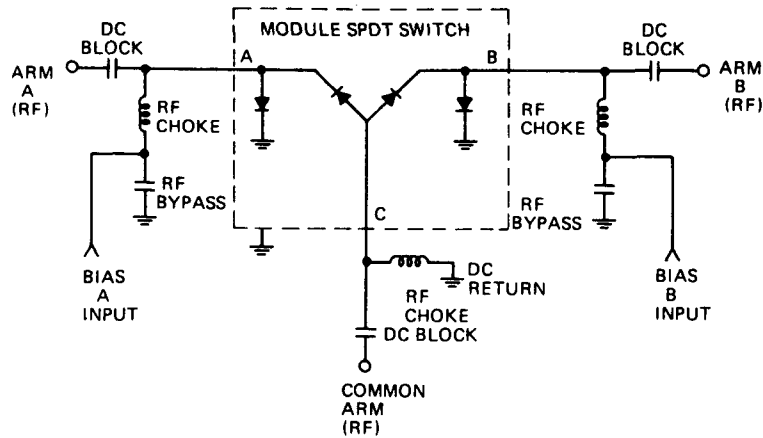

Figure 3 Typical Bias Circuit

Bias is applied externally to the module switch.

Arm A is connected to the common arm when negative current is applied to Bias A and positive current is applied to Bias B.

Arm B is connected to the common arm when negative current is applied to Bias B and positive current is applied to Bias A.

Switching Speed

The switching time from arm A to arm B is the time between the instant the RF signal in arm A has dropped 0.5 dB below the normal insertion loss until the RF signal in arm B has risen to 0.5 dB of its final insertion loss.

The fastest switching speeds can be realized by using a "spiked" waveform. For example, to connect arm B to the common arm, the following waveforms would be required.

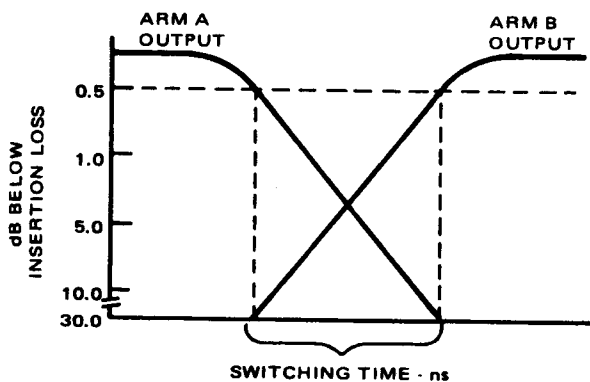

Figure 4

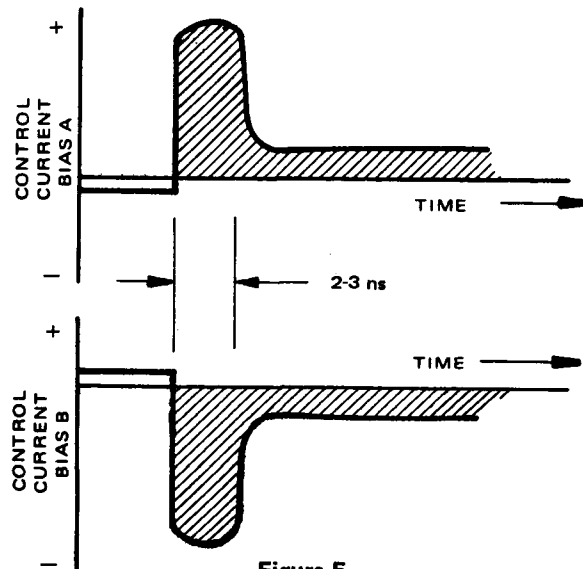

Figure 5

Microwave Tuning Varactors

Bulletin 4650

CONTROL DIODES

Silicon, MA-45000 Series

GaAs, MA-46600 Series

Silicon

Tuning Varactors

MA-45000 Series

DESCRIPTION

This series of silicon tuning varactors is designed to obtain the highest Q and largest capacitance change with bias by an essentially abrupt junction. High reliability, close capacitance tracking between diodes and a very low leakage result from Microwave Associates' "passivated metalized mesa" technique. These diodes are available in ceramic packages as well as the case style 54 glass package.

ELECTRICAL CHARACTERISTICS @ T_A = 25°C

Microwave Ceramic Tuning Varactors

Case Style 30				Case Style 30			
Model Number	Total Capac. @ -4 V 1 MHz pF ³	Min. ² Capac. Ratio	Min. Q ⁴ @ -4 V	Model Number	Total Capac. @ -4 V 1 MHz pF ³	Min. ² Capac. Ratio	Min. Q ⁴ @ -4 V
25 Volt Series				60 Volt Series			
C ₀ /C ₂₅				C ₀ /C ₆₀			
Highest Q				90 Volt Series			
C ₀ /C ₄₅				C ₀ /C ₉₀			
MA-45064	.5	3.1	4000	MA-45121	0.8	4.5	2000
MA-45065	.7	3.5	4000	MA-45122	1.2	5.0	2000
MA-45066	.9	3.6	4000	MA-45123	1.8	5.5	2000
MA-45067	1.2	3.6	3500	MA-45124	2.7	5.9	2000
MA-45068	1.8	3.8	3500	MA-45125	3.3	6.0	2000
High Q				MA-45126	4.7	6.5	1500
MA-45056	.5	3.1	3000	MA-45127	6.8	6.5	1500
MA-45055	.7	3.5	3000	MA-45128	10.0	7.0	1000
MA-45054	.9	3.6	3000	MA-45129	15.0	7.0	900
MA-45062	1.2	3.6	3000				
MA-45063	1.8	3.8	3000				
45 Volt Series							
C ₀ /C ₄₅							
MA-45101	0.8	4.2	2500				
MA-45102	1.2	4.5	2500				
MA-45103	1.8	4.9	2500				
MA-45104	2.7	5.2	2000				
MA-45105	3.3	5.4	2000				
MA-45106	4.7	5.4	2000				
MA-45107	6.8	5.4	1500				
MA-45108	10.0	5.4	1500				
MA-45109	15.0	5.5	1000				

GENERAL CHARACTERISTICS

Microwave Ceramic Tuning Varactors

CASE STYLE 30

Characteristic - All Types	Test Conditions	Symbol	Min.	Typ.	Units
Reverse Breakdown Voltage	I _R = 10 μA	V _B	Per Voltage Series V _B	5 V Greater than Voltage Series V _B	V dc
Reverse Leakage Current @ 80% V _{BR}	@ 25°C @ 150°C	I _R	-	.01 0.5	μA dc
Series Inductance (Excess Inductance)	f = 500 MHz	L _P	-	.40	nH
Case Capacitance	f = 1.0 MHz	C _P	-	-	pF
Diode Capacitance Temperature Coefficient	V _R = 4 V f = 1.0 MHz	TC _C	-	300	ppm/°C



MICROWAVE ASSOCIATES, INC. BURLINGTON, MASSACHUSETTS

ELECTRICAL CHARACTERISTICS @ T_A = 25°C

Microwave Glass Tuning Varactors

Case Style 54¹

Model Number	Total ³ Capac. @ -4 V pF	Capac. Ratio		Min. ⁴ Q @ -4 V	Model Number	Total ³ Capac. @ -4 V pF	Capac. ² Ratio		Min. ⁴ Q @ -4 V
		Min. C ₄ /C ₄₅	Typ. C ₀ /C ₄₅				Min. C ₄ /C ₆₀	Typ. C ₀ /C ₆₀	
45 Volt Series					60 Volt Series				
MA-45165	2.7	2.3	5.3	2000	MA-45156	3.3	2.8	6.2	1500
MA-45166	3.3	2.4	5.5	2000	MA-45157	4.7	2.8	6.5	1500
MA-45167	4.7	2.4	5.5	2000	MA-45158	6.8	2.8	6.5	1500
MA-45168	6.8	2.6	5.5	1500	MA-45159	8.2	2.8	6.8	1200
MA-45169	8.2	2.6	5.5	1500	MA-45160	10.0	2.8	7.0	1000
MA-45170	10.0	2.7	5.5	1500	MA-45161	12.0	2.8	7.0	1000
MA-45171	12.0	2.7	5.5	1200					

NOTES:

- On special order, these devices are also available in other case styles including 31, 94, 96, 108 and as chips.
- Total and capacitance ratios will vary with different packages due to different package parasitics. This is shown by comparison of figures 5 and 6 which allow the determination of total capacitance ratios between any two voltages for the case styles 30 and 54 respectively.
- Typical capacitance tolerances are ±10%. Tighter tolerances may be obtained by adding suffix:

A = ±5%
B = ±2%

- Diode Q is measured at 3.3 GHz and extrapolated down to 50 MHz by: $Q_{50 \text{ MHz}} = Q_{3.3 \text{ GHz}} \times \frac{3.3 \text{ GHz}}{50 \text{ MHz}}$

Case Style 54

Characteristic - All Types	Test Conditions	Symbol	Min.	Typ.	Units
Reverse Breakdown Voltage: 60 V Series 45 V Series	I _R = 10 μA	V _B	60 45	65 50	V _{dc}
Reverse Leakage Current: 60 V Series	V _R = 55 V, T _A = 25°C V _R = 55 V, T _A = 150°C	L _p	—	0.02	μA dc
45 V Series	V _R = 40 V, T _A = 25°C V _R = 40 V, T _A = 150°C			0.5	
Series Inductance (Excess Inductance)	f = 500 MHz, lead length = 1/16"	L _S	—	2.5	nH
Case Capacitance	f = 1.0 MHz	C _p	—	0.05	pF
Diode Capacitance Temperature Coefficient	V _R = 4 V f = 1.0 MHz	T _{CC}	—	300	ppm/°C

TYPICAL PERFORMANCE CURVES

FIGURE 1 TYPICAL CAPACITANCE VS. REVERSE BIAS

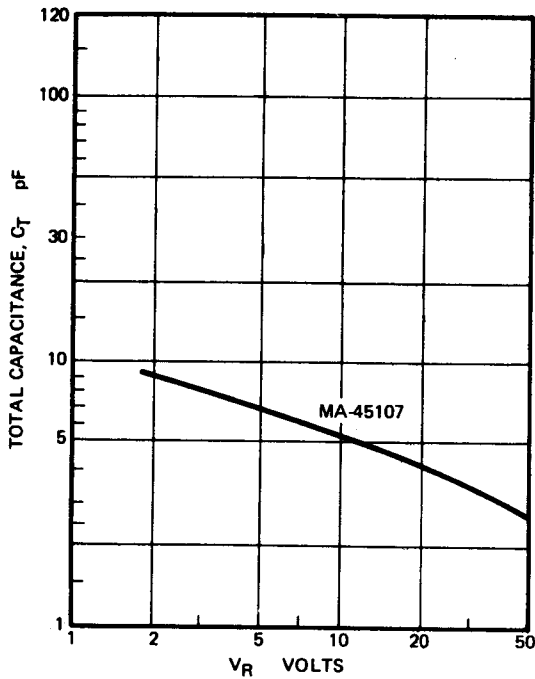

FIGURE 2 MA-45107
REVERSE CURRENT VS. REVERSE BIAS

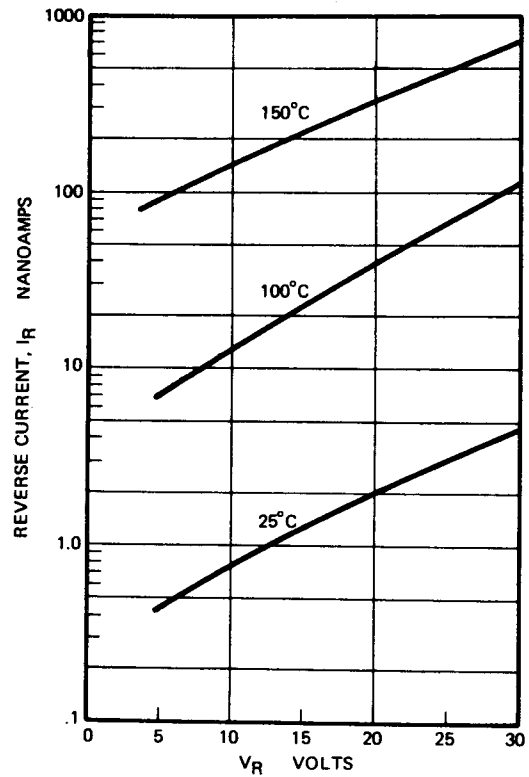

FIGURE 3 TUNING VARACTOR Q AT 50 MHz
VS. REVERSE VOLTAGE

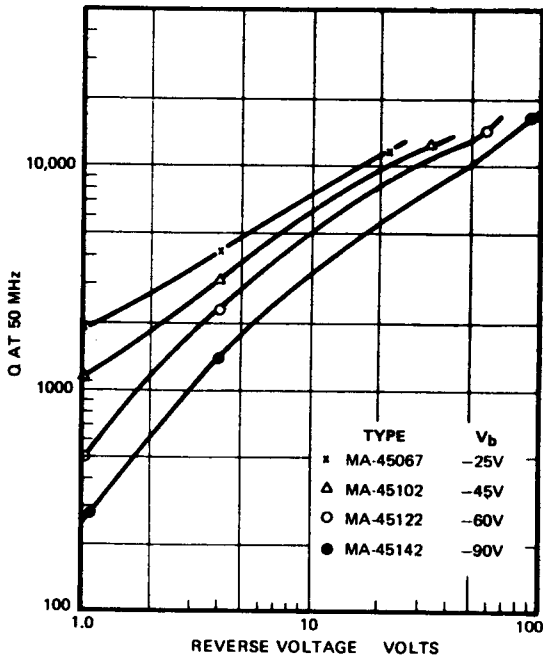
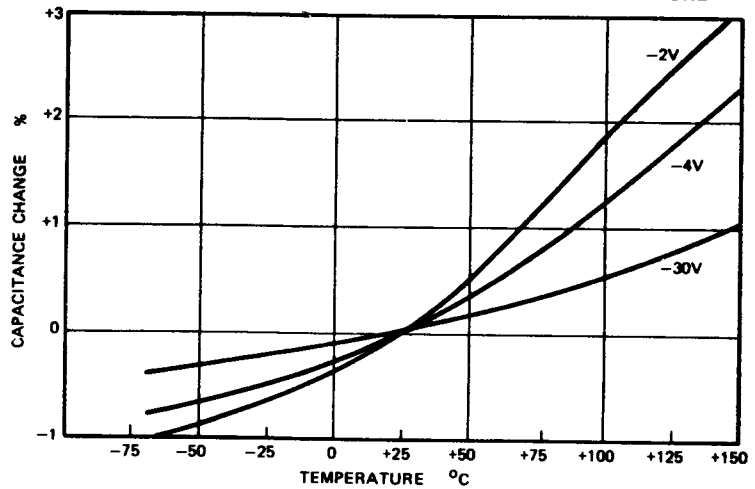

FIGURE 4 TYPICAL CAPACITANCE CHANGE VS. TEMPERATURE



TYPICAL PERFORMANCE CURVES (continued)

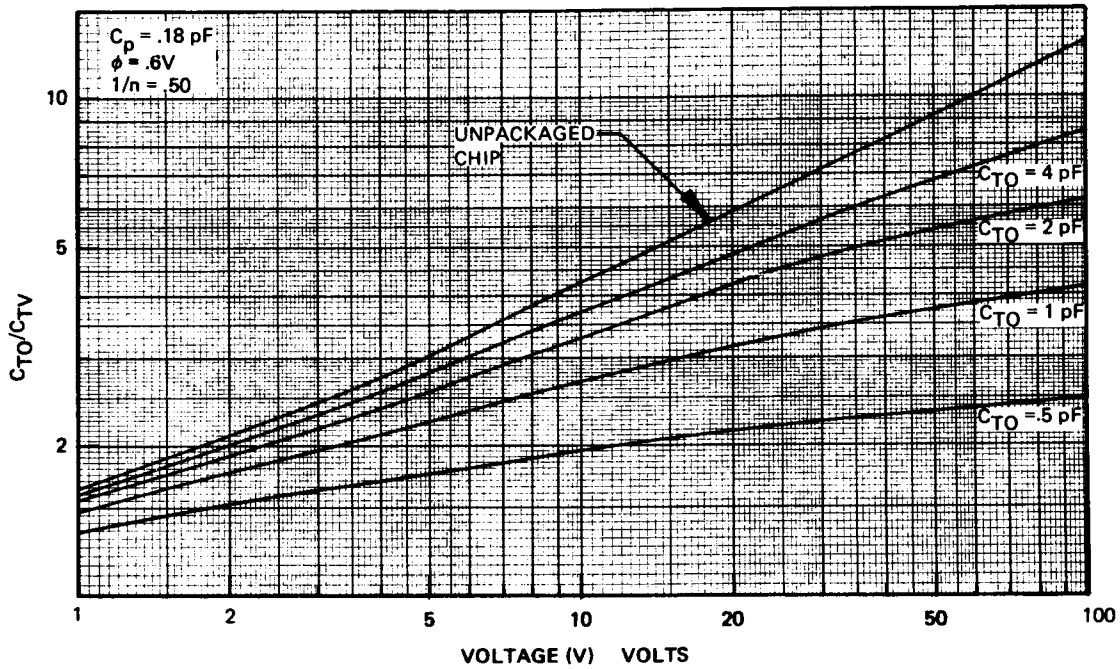

FIGURE 5 CAPACITANCE CHANGE RATIOS FOR SILICON TUNING VARACTORS IN CASE STYLE 30

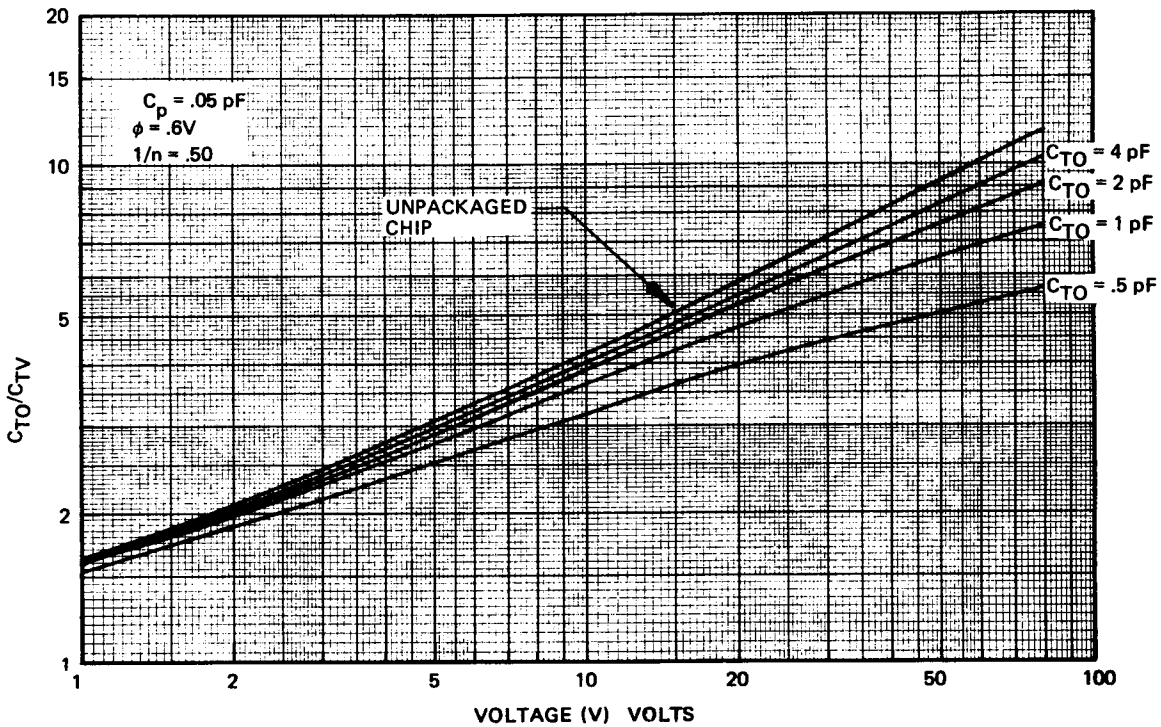

FIGURE 6 CAPACITANCE CHANGE RATIOS FOR SILICON TUNING VARACTORS IN CASE STYLE 54

GaAs

Tuning Varactors

MA-46600 Series

DESCRIPTION

The MA-46600 series of tuning varactors are abrupt junction gallium arsenide devices featuring "Q factors" in excess of 4000. This series is specifically designed for broadband high Q tuning performance from VHF through Ka-band. High reliability, low leakages and close capacitance tracking between diodes is typical of these devices. Standard capacitance matching is $\pm 10\%$ but closer matching is available on request. All diode types are available in a wide selection of ceramic packages as well as in chip form. The series is available in three minimum breakdown voltage ranges: 30 volts, 45 volts and 60 volts.

ELECTRICAL CHARACTERISTICS @ $T_A = 25^\circ\text{C}$

$V_B = 30 \text{ VOLTS}$

Minimum Q^1	C_{TO} (pF) (Capacitance Range) ¹				
	.50 - .99	1.00 - 1.49	1.50 - 1.99	2.00 - 2.49	2.50 - 2.99
4,000	MA-46600-D	MA-46601-D	MA-46602-D	MA-46603-D	MA-46604-D
5,000	MA-46600-E	MA-46601-E	MA-46602-E	MA-46603-E	
6,000	MA-46600-F	MA-46601-F	MA-46602-F		
7,000	MA-46600-G	MA-46601-G			
8,000	MA-46600-H				
9,000	MA-46600-J				

$V_B = 45 \text{ VOLTS}$

Minimum Q^1	C_{TO} (pF) (Capacitance Range) ¹				
	.50 - .99	1.00 - 1.49	1.50 - 1.99	2.00 - 2.49	2.50 - 2.99
4,000	MA-46610-D	MA-46611-D	MA-46612-D	MA-46613-D	MA-46614-D
5,000	MA-46610-E	MA-46611-E	MA-46612-E	MA-46613-E	
6,000	MA-46610-F	MA-46611-F	MA-46612-F		
7,000	MA-46610-G	MA-46611-G			
8,000	MA-46610-H				

$V_B = 60 \text{ VOLTS}$

Minimum Q^1	C_{TO} (pF) (Capacitance Range) ¹				
	.50 - .99	1.00 - 1.50	1.50 - 1.99	2.00 - 2.49	2.50 - 2.99
4,000	MA-46620-D	MA-46621-D	MA-46622-D	MA-46623-D	MA-46624-D
5,000	MA-46620-E	MA-46621-E	MA-46622-E	MA-46623-E	
6,000	MA-46620-F	MA-46621-F			
7,000	MA-46620-G				

NOTES:

- Customer should specify, within the range indicated, the required capacitance. The nominal tolerance is $\pm 10\%$ of the customer requested value. Closer tolerances are available on request.
- All GaAs Tuning Varactors are available in the cases indicated in this bulletin as well as in chip form. When ordering, specify the desired case by adding the case designation as a suffix to the type number. For example: an MA-46601-E-30 specifies a 30 volt tuning diode in the ODS-30 package with a C_{TO} between 1.000 and 1.499 and a Q (at -4 volts and 50 MHz) ≥ 5000 .
- Capacitance is measured at 1 MHz on a bridge which has been balanced with a shielded test holder connected in place but open circuited.
- All junctions are abrupt. i. e. $\frac{1}{n} \geq .50$

$$\text{where } C_{JV} = \frac{C_{JO}}{\left(1 + \frac{V_R}{1.2}\right)^{\frac{1}{n}}}$$

Total capacitance ratios will vary with case choice due

to differences in case capacitance (C_p). Figures 2 and 3 show typical ratios for the M/A 30 and 155 case styles respectively.

- Case parasitics (C_p and L_p) are given along with case outlines elsewhere in this bulletin. The C_p values listed typically have tolerances of ± 0.2 pF. However, the actual case capacitance of each diode is measured to within ± 0.0025 pF.
- Diode Q is measured by the DeLoach Technique and extrapolated to -4 Volts, 50 MHz.
- All GaAs tuning diodes are subjected to a 48 hour 100°C electrical burn-in before final tests. During this period each device is stressed 60 times per second with 30 mA in the forward direction and 5 volts in the back direction.
- Parasitic inductance (L_p) has been determined at X-Band using a DeLoach method measurement.
- Breakdown voltage (V_{BR}) is measured at $-10 \mu\text{A}$.
- The shielded test holders used for capacitance measurements are available for purchase.



MICROWAVE ASSOCIATES, INC. BURLINGTON, MASSACHUSETTS

PERFORMANCE CURVES

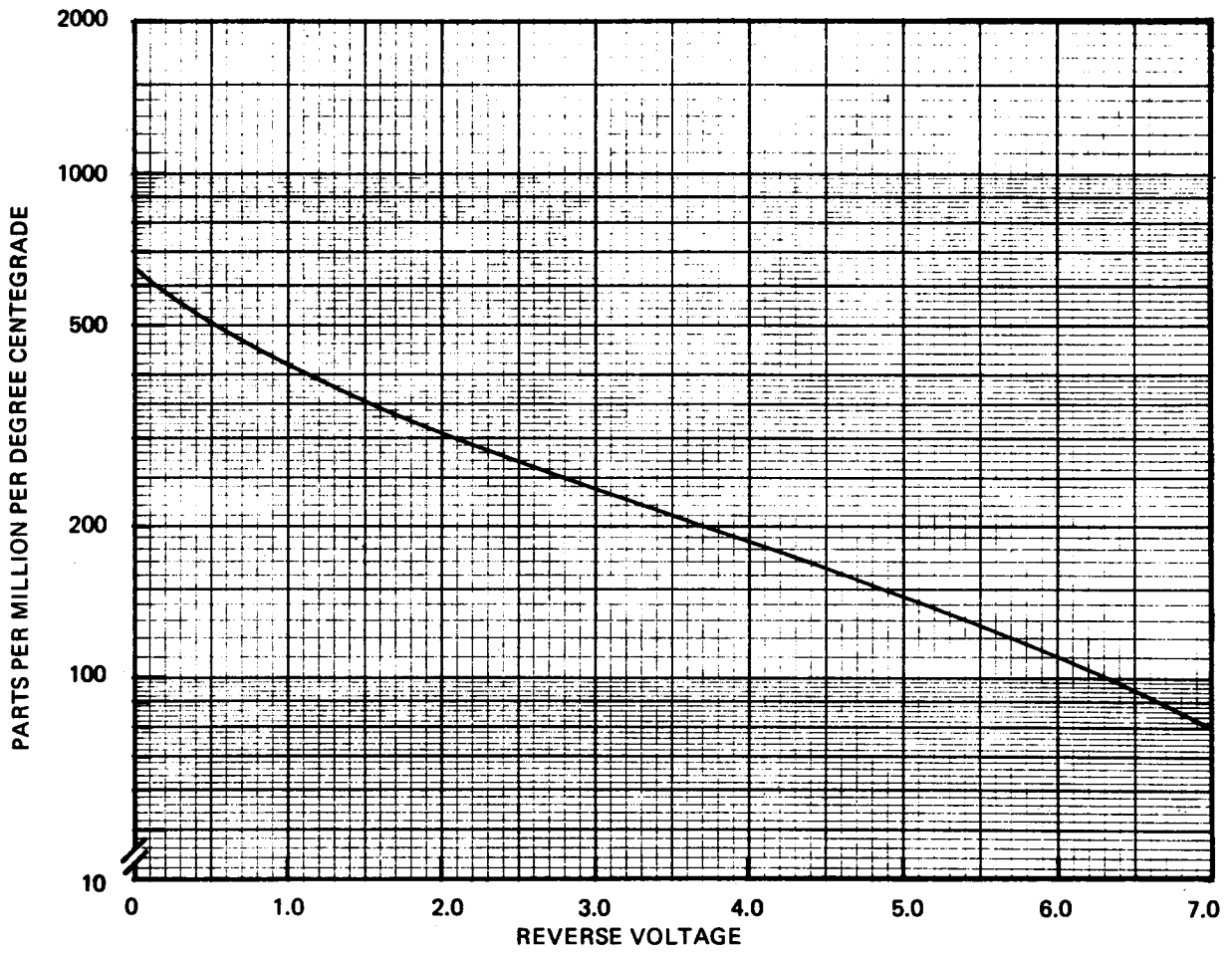

FIGURE 1 TEMPERATURE COEFFICIENT OF GaAs TUNING DIODES

CONTROL DIODES

TYPICAL PERFORMANCE CURVES (continued)

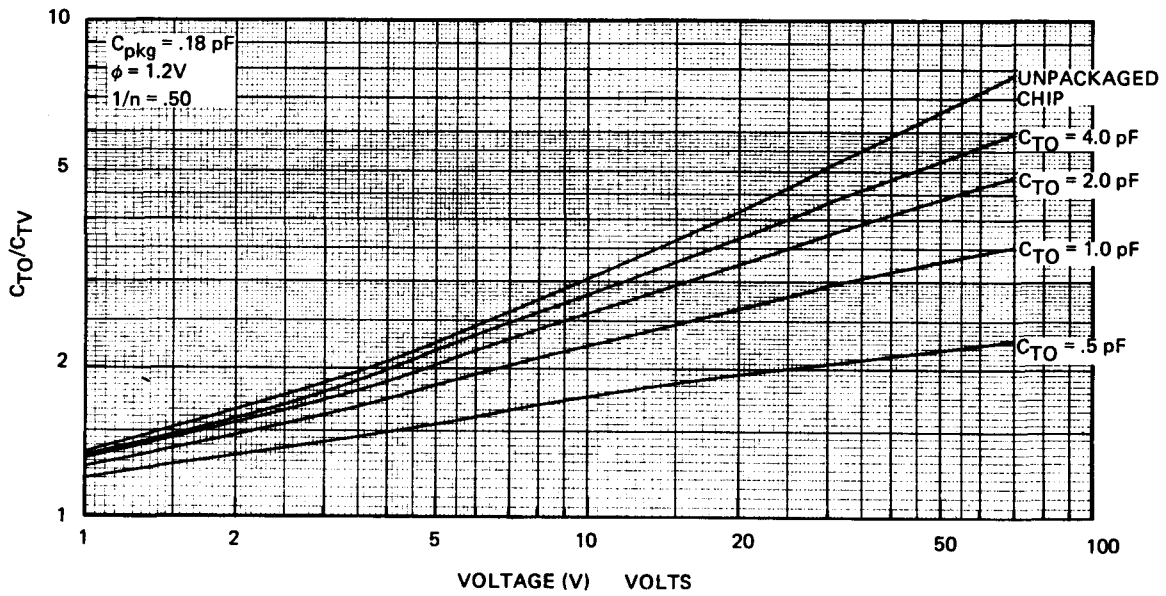

FIGURE 2 CAPACITANCE CHANGE RATIOS FOR GaAs TUNING VARACTORS IN CASE STYLE 30

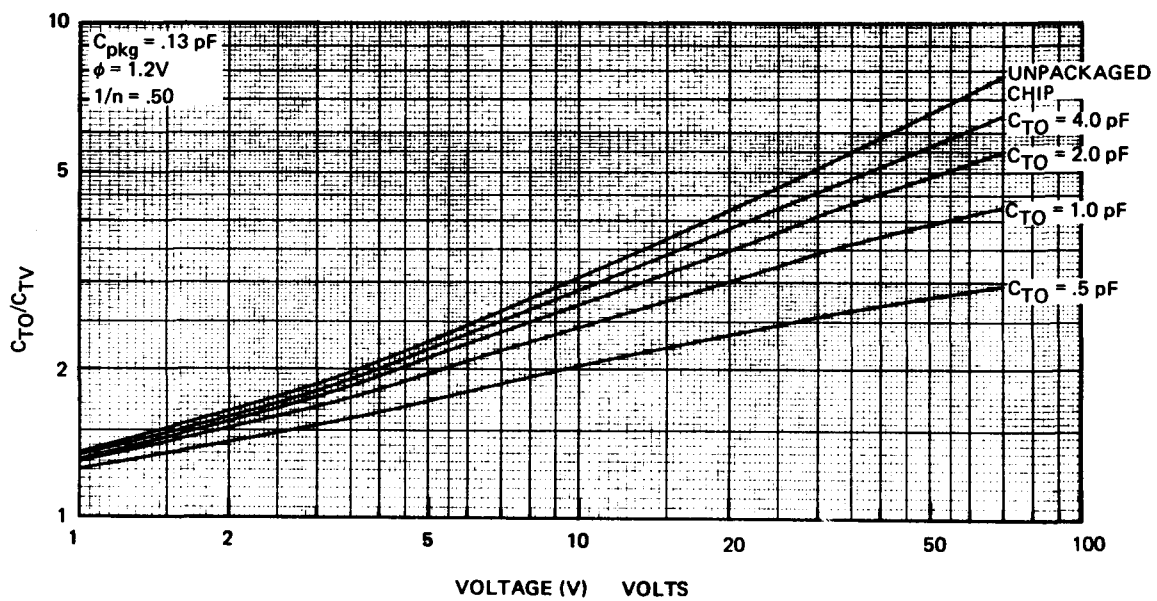
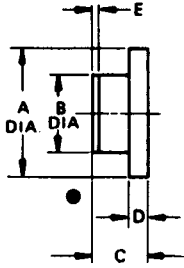

FIGURE 3 CAPACITANCE CHANGE RATIOS FOR GaAs TUNING VARACTORS IN CASE STYLE 155

126



TYPICAL
 $L_p = .2 \text{ nH}$
 $C_p = .23 \text{ pF}$

DIM.	INCHES		MM	
	MIN.	MAX.	MIN.	MAX.
A	.079	.087	2.01	2.21
B	.047	.053	1.19	1.35
C	.030	.036	0.76	0.97
D	.009	.015	0.23	0.38
E	.003 REF.		0.076 REF.	

128

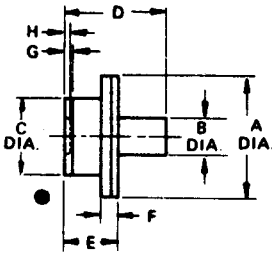

TYPICAL
 $L_p = .20 \text{ nH}$
 $C_p = .23 \text{ pF}$

DIM.	INCHES		MM	
	MIN.	MAX.	MIN.	MAX.
A	.077	.083	1.96	2.11
B	.022	.028	0.56	0.71
C	.047	.053	1.19	1.35
D	.0545	.0675	1.38	1.71
E	.0295	.0325	0.75	0.83
F	.010	.015	0.25	0.38
G	.002	.007	0.05	0.17
H	.0015	.0030	0.04	0.08

130¹

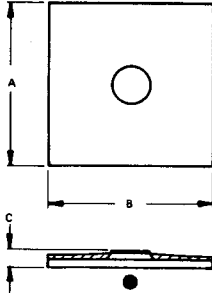

DIM.	INCHES		MM	
	MIN.	MAX.	MIN.	MAX.
A	.075	.085	1.90	2.51
B	.075	.085	1.90	2.51
C	.0085	.0105	0.021	0.026

131¹

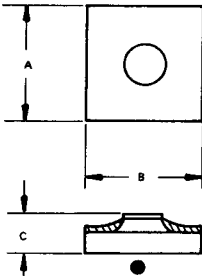

DIM.	INCHES		MM	
	MIN.	MAX.	MIN.	MAX.
A	.030	.035	0.762	0.889
B	.030	.035	0.762	0.889
C	.0085	.0105	0.021	0.026

132¹

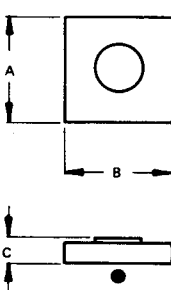

DIM.	INCHES		MM	
	MIN.	MAX.	MIN.	MAX.
A	.020	.024	0.508	0.609
B	.020	.024	0.508	0.609
C	.003	.006	0.076	0.152

134¹

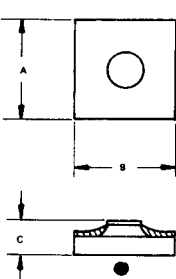

DIM.	INCHES		MM	
	MIN.	MAX.	MIN.	MAX.
A	.0135	.0165	0.3429	0.4191
B	.0135	.0165	0.3429	0.4191
C	.0035	.0065	0.0889	0.1651

155

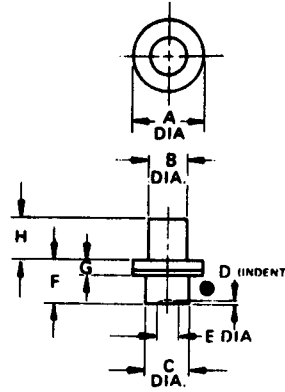

TYPICAL
 $L_p = .16 \text{ nH}$
 $C_p = .13 \text{ pF}$

DIM.	INCHES		MM	
	MIN.	MAX.	MIN.	MAX.
A	.043	.047	1.09	1.19
B	.024	.026	0.61	0.66
C	.029	.031	0.74	0.79
D	.001	.002	0.03	0.05
E	.018	.010	0.41	0.25
F	.022	.028	0.56	0.71
G	.007	.009	0.18	0.23
H	.026	.034	0.66	0.86

156

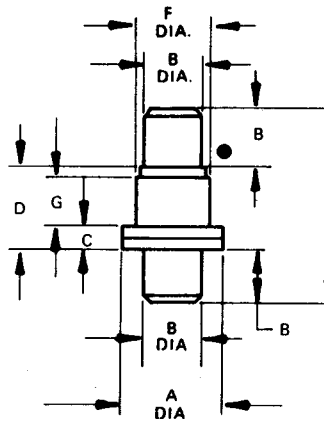

TYPICAL
 $L_p = .40 \text{ nH}$
 $C_p = .24 \text{ pF}$

DIM.	INCHES		MM	
	MIN.	MAX.	MIN.	MAX.
A	.117	.123	2.97	3.12
B	.060	.064	1.52	1.63
C	.016	.024	0.40	0.61
D	.056	.065	1.40	1.65
E	.174	.194	4.42	4.93
F	.077	.083	1.96	2.11
G	.033 REF.		0.84 REF.	

157

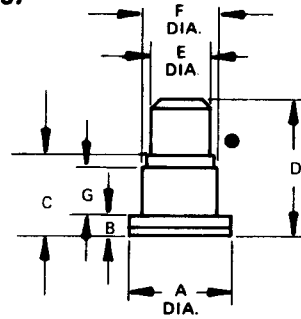

TYPICAL
 $L_p = .40 \text{ nH}$
 $C_p = .24 \text{ pF}$

DIM.	INCHES		MM	
	MIN.	MAX.	MIN.	MAX.
A	.117	.123	2.97	3.12
B	.016	.024	0.41	0.61
C	.056	.065	1.40	1.65
D	.117	.127	2.97	3.23
E	.060	.064	1.52	1.63
F	.077	.083	1.96	2.11
G	.033 REF.		0.83 REF.	

168

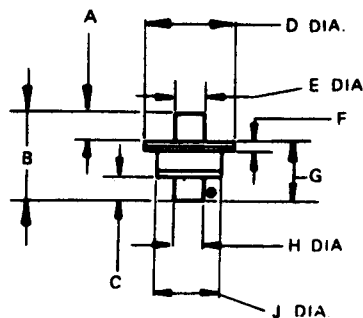

TYPICAL
 $L_p = .20 \text{ nH}$
 $C_p = .23 \text{ pF}$

DIM.	INCHES		MM	
	MIN.	MAX.	MIN.	MAX.
A	.028	.032	0.71	0.81
B	.084	.086	2.13	2.44
C	.028	.032	0.71	0.81
D	.079	.081	2.01	2.06
E	.024	.026	0.61	0.66
F	.008	.010	0.20	0.25
G	.048	.064	1.22	1.37
H	.024	.026	0.61	0.66

NOTE: 1. Silicon only.

● Denotes Cathode End.

Not to scale.

All specifications are subject to change without notice.

Tunnel Diodes for Switching Applications

Bulletin 5051

CONTROL DIODES

***Germanium
MA-4C100 Series***

***Gallium Arsenide
MA-4C550 Series***

FEATURES

- High speed switching at low power levels
- Low power usage
- High radiation resistance
- Tightly controlled parameters
- Hermetically sealed packages useful in printed circuit board or stripline applications
- Low-noise RF oscillator applications with low power consumption
- Higher power output from GaAs oscillator diode than from a germanium oscillator diode

Switching Tunnel Diodes

Germanium MA-4C100 Series

Gallium Arsenide MA-4C550 Series

CASE STYLES

**182
TYPE B**

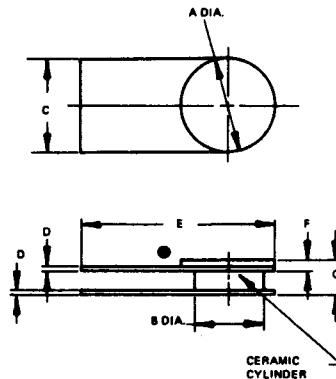

TYPICAL

$$L_p = 0.3 \text{ nH}$$

$$C_p = 0.35 \text{ pF}$$

DIM.	INCHES		MM	
	MIN.	MAX.	MIN.	MAX.
A	0.110	0.130	2.75	3.30
B	0.085	0.095	2.16	2.41
C	0.115	0.130	2.92	3.30
D	0.003	0.007	0.08	0.18
E	0.230	0.270	5.84	6.86
F	0.010	0.020	0.25	0.51
G	0.035	0.055	0.89	1.40

**183
TYPE C**

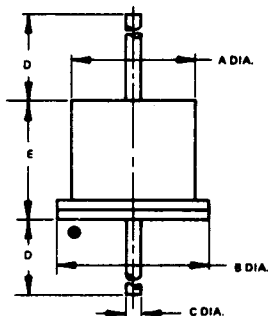

TYPICAL

$$L_p = 0.5 \text{ nH}$$

$$C_p = 0.45 \text{ pF}$$

DIM.	INCHES		MM	
	MIN.	MAX.	MIN.	MAX.
A	0.070	0.090	1.78	2.29
B	0.080	0.110	2.29	2.75
C	0.019	0.022	0.48	0.56
D	1.000	-	2.54	-
E	0.085	0.100	2.16	2.54

● Denote Cathode End

Not to scale.

ENVIRONMENTAL RATINGS PER MIL-STD-750

	Method	
Temperature, Storage	1031	See max. rating
Temperature, Operating	-	See max. rating
Temperature Cycling	1051	-65°C to +100°C 10 cycles
Shock	2016	1200 g's
Vibration	2056	20 g's
Constant Acceleration	2006	20,000 g's
Humidity	1021	10 days

MAXIMUM RATINGS @ T_A = 25°C (unless otherwise specified)

CW Dissipation (RF)	20 mW
DC Current	Note 1
Temperature, Storage	-65°C to +100°C
Temperature, Operating	-65°C to +100°C

NOTE:

1. DC Current

Germanium: 5.0 MA (or 2X I_p whichever is greater)

Gallium Arsenide: Forward Current (I_F) must be restricted to a value in milliamps equal to or less than one half the junction capacitance in pF.



MICROWAVE ASSOCIATES, INC. BURLINGTON, MASSACHUSETTS

ELECTRICAL CHARACTERISTICS @ $T_A = 25^{\circ}\text{C}$
JEDEC TYPE GERMANIUM DIODES

ODS-182			ODS-183		
Type	Typ. I_p mA	Max. C_T pF	Type	Typ. I_p mA	Max. C_T pF
1N3128	5.0	15	1N3712	1.0	10
1N3129	20.0	20	1N3713	1.0	5
1N3130	50.0	25	1N3714	2.2	25
1N3847	5.0	25	1N3715	2.2	10
1N3848	10.0	25	1N3716	4.7	50
1N3849	20.0	30	1N3717	4.7	25
1N3850	50.0	40	1N3719	10.0	50
1N3851	100.0	40	1N3720	22.0	150
1N3852	5.0	15	1N3721	22.0	100
1N3853	10.0	15			
1N3854	20.0	20			
1N3856	100.0	25			
1N3857	5.0	8			
1N3858	10.0	8			
1N3859	20.0	10			
1N3860	50.0	12			

GERMANIUM Switching Diodes

M/A Type	KMC Type	I_p^1 mA	I_p^2 Tolerance %	C_T^3 pF		Typ. V_p mV	Typ. V_v mV	Typ. V_f mV
				typ.	max.			
MA-4C100	G0500.5	0.5	5	0.8	1			
MA-4C102	G0000.5	0.5	10	1.0	2	50	320	460
MA-4C103	G05001	1.0	5	1.0	2			
MA-4C104	G00001	1.0	10	2.0	3	60	340	460
MA-4C105	G05005	5.0	5	2.5	3			
MA-4C106	G00005	5.0	10	3.5	5	70	350	480
MA-4C107	G05010	10.0	5	4.0	5			
MA-4C108	G00010	10.0	10	6.0	10	80	360	500
MA-4C109	G05020	20.0	5	8.0	10			
MA-4C110	G00020	20.0	10	15.0	20	90	370	540
MA-4C111	G05050	50.0	5	20.0	25			
MA-4C112	G00050	50.0	10	40.0	50	100	380	565
MA-4C113	G00100	100.0	10	60.0	100	110	390	575
MA-4C114	G00200	200.0	10	125.0	200	120	400	580

NOTES:

- $I_p/I_v > 6:1$ on all types.
- I_p can be held to tolerances of up to $\pm 3\%$ (please specify).
- I_p/C can be varied from $\frac{1}{4}$ to 3.
- V_f can be selected approx. $\pm 25\%$ to meet special requirements.
- Available in ODS-182 and 183.
- When ordering, specify the desired case style by adding the case designation as a suffix to the part number.

GALLIUM ARSENIDE Switching Diode and RF Oscillator Diodes

M/A Type	KMC Type	I_p^1 mA	I_p^2 Tolerance %	C_T^3 pF		Typ. V_p mV	Typ. V_v mV	Typ. V_f mV
				typ.	max.			
MA-4C550	A0500.5	0.5	5	0.8	1			
MA-4C551	A0000.5	0.5	10	1.0	2	100	500	950
MA-4C552	A05001	1.0	5	1.0	2			
MA-4C553	A00001	1.0	10	2.0	3	115	510	1000
MA-4C554	A05005	5.0	5	2.5	3			
MA-4C555	A00005	5.0	10	3.5	5	135	520	1050
MA-4C556	A05010	10.0	5	4.0	5			
MA-4C557	A00010	10.0	10	6.0	10	155	530	1100
MA-4C558	A05020	20.0	5	8.0	10			
MA-4C559	A00020	20.0	10	15.0	20	175	535	1125
MA-4C560	A05050	50.0	5	20.0	25			
MA-4C561	A00050	50.0	10	40.0	50	195	540	1150
MA-4C562	A00100	100.0	10	60.0	100	205	545	1175
MA-4C563	A00200	200.0	10	125.0	200	225	550	1200
—	1N3118	10.0	10	10.0	20	180	600	1100
—	1N3138	50.0	5	20.0	30	190	600	1100

NOTES:

- $I_p/I_v > 12:1$ on all types.
- I_p can be held to tolerances of up to $\pm 3\%$ (please specify).
- I_p/C can be varied from $\frac{1}{4}$ to 3.
- V_f can be selected approx. $\pm 25\%$ to meet special requirements.
- Available in ODS-182 and 183.
- When ordering, specify the desired case style by adding the case designation as a suffix to the part number.

POWER GENERATION AND AMPLIFICATION DEVICES

SELECTED GUIDE - Gunn Diodes	150
Low and Medium Power Gunn Diodes	151
High Power Gunn Diodes and Pulsed	151
High Frequency Gunn Diodes	169
Multiplier Diodes	173
GaAs Paramp Varactors	191
Transistors	199
Impatt Diodes	219
Tunnel Diodes	223

POWER GENERATION
AND AMPLIFICATION

SELECTION GUIDE-GUNN DIODES

Application Band	Intrusion Alarm	Police Radar and other Motion Detection	Communications Local Oscillators	Broadband YIG Tuned Oscillator or VCO	Communications Transmitter and Power Amplifier	Paramp Pump
C	-	MA-49152 MA-49137 MA-49153	MA-49136 MA-49137 MA-49138	MA-49140-118	MA-49137 MA-49145 MA-49146 MA-49147 MA-49148	-
X	MA-49508 MA-49618	MA-49107 MA-49157 MA-49158 MA-49508	MA-49106 MA-49107 MA-49109	MA-49117-118	MA-49110 MA-49183 MA-49184 MA-49189	MA-49109
Ku	MA-49162 MA-49163	MA-49162 MA-49163 MA-49122 MA-49123	MA-49122 MA-49123	MA-49126-118 MA-49126-138	MA-49124 MA-49164	MA-49124
K	MA-49628	MA-49628 MA-49179-118 MA-49180	MA-49179-118	MA-49128-138	MA-49178	MA-49179 MA-49180
Ka	-	-	MA-49172	-	MA-49177	MA-49172 MA-49173 MA-49177
V	-	-	-	-	MA-49181 MA-49182	MA-49181 MA-49182



MICROWAVE ASSOCIATES, INC. BURLINGTON, MASSACHUSETTS

Low and Medium Power Gunn Diodes

Bulletin 4551

POWER GENERATION
AND AMPLIFICATION

Motion Detector Applications

Low Noise Oscillator Applications

DESCRIPTION

These GaAs Gunn Diodes, designed to operate through bulk negative resistance effect, feature low FM and AM noise characteristics, and accomplish a one-step conversion from DC-to-microwave energy from a single low voltage supply, thereby eliminating complex circuitry.

APPLICATIONS

Microwave Associates Gunn Diodes are ideally suited for use in low noise sources such as local oscillators, locking oscillators, low power radar applications, and motion detection applications.

FEATURES

- Low AM/FM Noise Characteristics
- Low Voltage Operation
- Case Style Flexibility

Low and Medium Power Gunn Diodes

Motion Detection

CASE STYLES

30

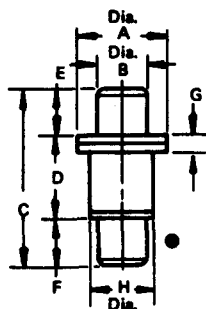

DIM.	INCHES		MM	
	MIN.	MAX.	MIN.	MAX.
A	.119	.127	3.02	3.23
B	.060	.064	1.52	1.63
C	.205	.225	5.21	5.72
D	.085	.097	2.16	2.46
E	.060	.064	1.52	1.63
F	.060	.064	1.52	1.63
G	.016	.024	0.41	0.61
H	.079	.083	2.01	2.11

Not to scale.

111

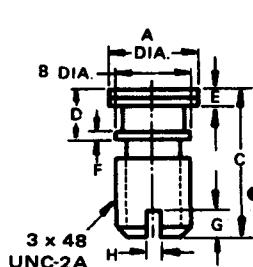

DIM.	INCHES		MM	
	MIN.	MAX.	MIN.	MAX.
A	.119	.127	3.02	3.22
B	.060	.102	2.49	2.59
C	.188	.208	4.78	5.28
D	.057	.071	1.45	1.80
E	.016	.024	0.41	0.61
F	.009	.011	0.23	0.28
G	.030	.040	0.76	1.02
H	.015	.025	0.38	0.64

● Denotes Cathode End.

ABSOLUTE MAXIMUM RATINGS

Storage Temperature: -60° to $+175^{\circ}\text{C}$

Active Region Temperature: 260°C

ELECTRICAL CHARACTERISTICS (At diode case temperature of 25°C)

CATHODE HEAT SINK DIODES

Frequency GHz	Package Style	Model Number	Min. Power ¹ mW	V _{op} Volts		I _{op}		AM Noise ²	
				Typ.	Max.	Min.	Max.	Volts RMS Millivolts RMS	
								5-300 Hz	300-500 Hz
9.2-10.7	30	MA-49157	50	10.0	12.0	300	450	0.22	0.22
		MA-49158	100	10.0	12.0	450	650	0.22	0.22
	111	MA-49106	50	10.0	12.0	300	450	0.22	0.22
		MA-49107	100	10.0	12.0	450	650	0.22	0.22
14.1	30	MA-49162	50	8.0	10.0	300	500	0.22	0.22
		MA-49163	100	8.0	10.0	500	750	0.22	0.22
	111	MA-49122	50	8.0	10.0	300	500	0.22	0.22
		MA-49123	100	8.0	10.0	500	750	0.22	0.22

ANODE HEAT DIODES

9.4 or 10.525	30	MA-49618	5	7.0	12.0	80	0.22	0.22
9.4 or 10.525	30	MA-49508	10	7.0	12.0	160	0.22	0.22
22	30	MA-49628	10	5.0	8.0	200	0.22	0.22

NOTES:

- Power is measured into a critically coupled load at a customer specified single frequency in the indicated range.
- The AM noise of the Gunn diodes follows approximately a 1/f law close to the carrier. For a system application, the absolute noise in terms of dB below carrier in a given bandwidth is of little value. Hence, the AM noise is specified in terms of the RMS voltage output of an amplifier with a voltage gain of 100,000 across the band 5 Hz - 300 Hz (with a band rejection filter at 120 Hz) or, as the RMS voltage output of an amplifier with a voltage

- gain of 1000 across the band 300 - 5000 Hz. The Gunn oscillator power supply is assumed to have a ripple voltage not exceeding 0.2 mV RMS. It is also assumed that 0.5 mW of RF power is incident on the detector (type MA-40074), of sensitivity 80 mV/mW.
- M/A will provide engineering drawings of the test cavities upon request. Also, we will provide technical assistance in the specification and selection of Gunn diodes, detector diodes and suitable cavities.



MICROWAVE ASSOCIATES, INC. BURLINGTON, MASSACHUSETTS

Low and Medium Power Gunn Diodes

Low Noise Oscillator Applications

CASE STYLES

30

TYPICAL
 $L_p = .42 \text{ nH}$
 $C_p = .20 \text{ pF}$

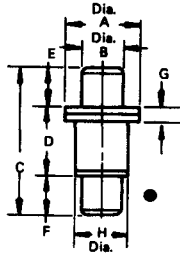

DIM.	INCHES		MM	
	MIN.	MAX.	MIN.	MAX.
A	.119	.127	3.02	3.23
B	.060	.064	1.52	1.63
C	.206	.226	5.21	5.72
D	.085	.097	2.16	2.48
E	.050	.064	1.52	1.63
F	.060	.064	1.52	1.63
G	.016	.024	0.41	0.61
H	.079	.083	2.01	2.11

111

TYPICAL
 $L_p = .24 \text{ nH}$
 $C_p = .32 \text{ pF}$

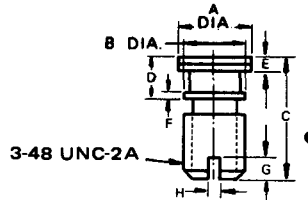

DIM.	INCHES		MM	
	MIN.	MAX.	MIN.	MAX.
A	.119	.127	3.02	3.22
B	.066	.102	2.49	2.59
C	.188	.208	4.78	5.28
D	.057	.071	1.45	1.80
E	.016	.024	0.41	0.61
F	.009	.011	0.23	0.28
G	.030	.040	0.76	1.02
H	.015	.025	0.38	0.64

118

TYPICAL
 $L_p = .16 \text{ nH}$
 $C_p = .22 \text{ pF}$

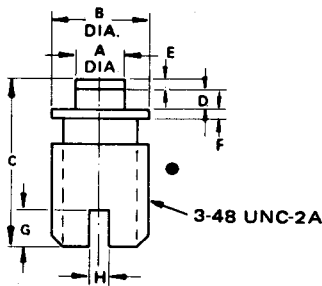

DIM.	INCHES		MM	
	MIN.	MAX.	MIN.	MAX.
A	.048	.052	1.22	1.32
B	.098	.102	2.49	2.59
C	.165	.185	4.19	4.69
D	.014	.018	0.356	0.467
E	.008	.012	0.20	0.31
F	.009	.011	0.23	0.28
G	.030	.040	0.76	1.02
H	.015	.025	0.38	0.64

138

TYPICAL
 $L_p = .1 \text{ nH}$
 $C_p = .18 \text{ pF}$

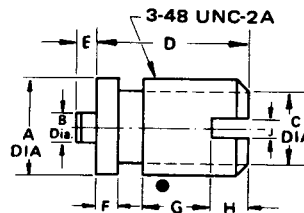

DIM.	INCHES		MM	
	MIN.	MAX.	MIN.	MAX.
A	.113	.118	2.87	3.00
B	.027	.034	0.69	0.86
C	.068	.070	1.73	1.78
D	.140	.145	3.56	3.68
E	.016	.019	0.41	0.48
F	.018	.022	0.46	0.56
G	.015	.025	0.38	0.64
H	.030	.040	0.76	1.02
J	.015	.025	0.38	0.64

Not to scale.

● Denotes Cathode End.

ABSOLUTE MAXIMUM RATINGS

Storage Temperature: -60°C to $+175^{\circ}\text{C}$

Active Region Temperature: 260°C



MICROWAVE ASSOCIATES, INC. BURLINGTON, MASSACHUSETTS

ELECTRICAL CHARACTERISTICS @ 25°C
CW GUNN DIODES (CATHODE HEAT SINK)

LOW POWER CW GUNN DIODES

Frequency ² Range GHz	Package Style	Model Number	Min. P out ¹ mW	V _{op} Volts		I _{op} mA		I _{th} mA Max.	Max. Thermal Resistance °C/W
				Min.	Max.	Min.	Max.		
5.0-8.0	30	MA-49151	25	10	14	150	250	350	45
		MA-49152	50	10	14	250	350	500	35
	111	MA-49135	25	10	14	150	250	350	45
		MA-49136	50	10	14	250	350	500	35
8.0-12.4	30	MA-49156	25	8	12	200	300	400	45
		MA-49157	50	8	12	300	450	650	35
	111	MA-49104	25	8	12	200	300	500	45
		MA-49106	50	8	12	300	450	650	35
12.4-18.0	30	MA-49161	25	6	10	200	300	500	45
		MA-49162	50	6	10	300	500	700	35
	111	MA-49121	25	6	10	200	300	500	45
		MA-49122	50	6	10	300	500	700	35

MEDIUM POWER CW GUNN DIODES

5.0-8.0	30	MA-49153	100	10	14	350	500	700	25
		MA-49154	250	10	14	500	700	1000	17
	111	MA-49137	100	10	14	350	500	700	25
		MA-49138	250	10	14	500	700	1000	17
8.0-12.4	30	MA-49158	100	8	12	450	650	950	24
		MA-49159	250	8	12	750	1050	1500	15
	111	MA-49107	100	8	12	450	650	950	24
		MA-49109	250	8	12	750	1050	1500	15
12.4-18.0	30	MA-49163	100	6	10	500	750	1100	24
		MA-49164	250	6	10	850	1150	1700	15
	111	MA-49123	100	6	10	500	750	1100	24
		MA-49124	250	6	10	850	1150	1700	15

NOTES:

1. The minimum power is guaranteed into a critically coupled load at a single frequency to be specified by the customer within the indicated band.
2. Specific frequency should be specified by the customer.

POWER GENERATION
AND AMPLIFICATION

TYPICAL PERFORMANCE CURVES

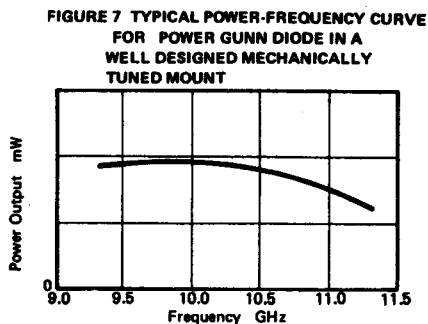
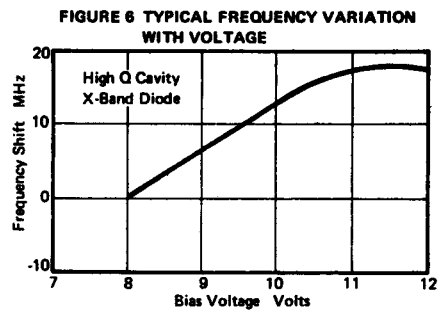
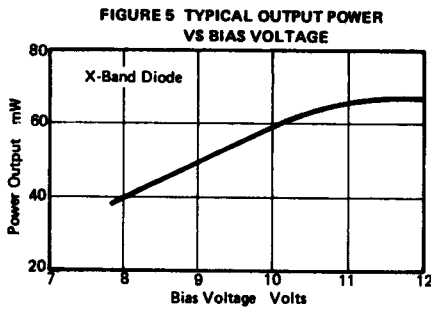
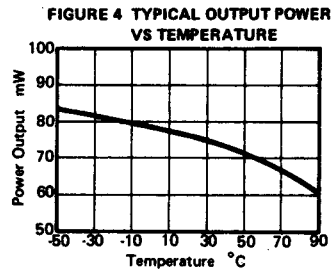
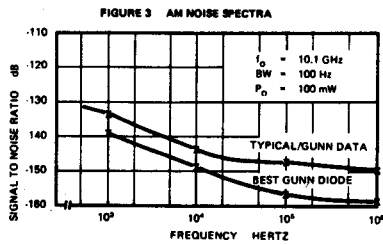
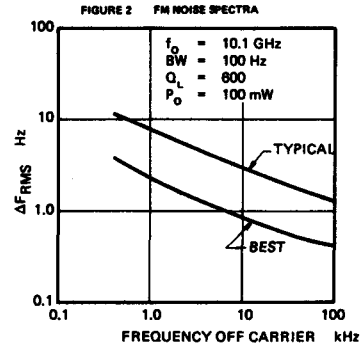
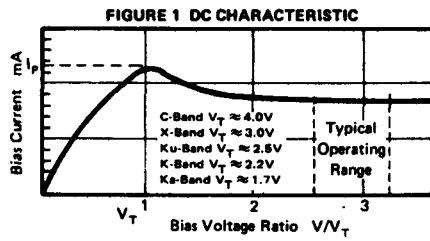

Gunn Diodes

Yig Oscillator, Varactor Tuned Oscillator Applications

ELECTRICAL CHARACTERISTICS @ 25°C

Frequency Range GHz	Case Style	Model Number	Min. P out * mW	V _{op} Volts		I _{op} mA	
				Min.	Max.	Min.	Max.
5.0 - 8.0	118	MA-49140-118	100	10	14	350	550
8.0 - 12.4	118	MA-49117-118	100	8	12	450	600
12.4 - 18.0	118	MA-49126-118	100	6	10	500	750
12.4 - 18.0	138	MA-49126-138	100	6	10	500	750
18.0 - 26.5	138	MA-49128-138	100	4	8	500	900

* Critically coupled at discrete frequencies across the band.

NOTES:

- Each diode is supplied with operating data: threshold voltage and current, operating voltage and current, frequency, power.
- Maximum threshold current is 1.5 times the maximum operating current (see also application note).
- Bellows or prong cap for the ODS-111 package is available on special request.
- These diodes are designed to operate within a heat sink temperature of -54 to +75°C.

DIODE MOUNTING PROCEDURE

The mount used for the diode must provide an adequate thermal path away from the diode stud. During initial operation it is always advisable to monitor the diode case temperature, (T_c), by means of a thermocouple placed in the screw driver slot at the base of the diode case. As the bias voltage is slowly increased from zero volts, the case temperature should be monitored to ensure adequate heat sinking. As a rule of thumb, the heat sinking is probably adequate if the threshold current measured in the actual oscillator is more than 95% of the threshold current indicated in the accompanying data sheet. (The threshold current is an inverse function of junction temperature). If the junction is too hot because of an inadequate heat sink, the threshold current will decrease to less than 95% of the quoted value. The current through the diode below the threshold is given by:

$$I = \frac{c}{T^a}$$

I = current

T = absolute temperature

a = constant depending on material (typically 1.0 - 1.3)

c = a proportionality constant

The current flow is very sensitive to junction temperature.

Diodes in threaded packages should be securely tightened into a clean, sharply tapped 3 - 48 UNC 2A threaded hole in a copper mount. A torque of approximately 6 inch-ounces should be used in tightening the diode. As an alternative mounting process the diode may be soldered into the mount, using a minimum of clearance for solder between the diode and the mounting hole. The diode and mount should be degreased and tinned with solder before the insertion of the diode. We recommend use of a 60-40 eutectic lead-tin solder with a melting point of ≈ 180°C. Diodes in prong packages should be soldered in or securely gripped in collet clamps.



MICROWAVE ASSOCIATES, INC. BURLINGTON, MASSACHUSETTS

POWER GENERATION
AND AMPLIFICATION

APPLICATION NOTES

- Under pulse conditions (20 nanoseconds), the Gunn diode can withstand a voltage many times the threshold voltage (as well as many times the operating voltage). At the switching voltage, diode pulsed current increases rapidly as in the breakdown phenomenon of junction devices. This switching voltage point is an indication of the quality of the device. Typically the switching voltage ratio to threshold voltage is $(V_S/V_T) \approx 25$.
- The Gunn diode is not in the true sense a "diode." However, due to construction methods, it has a preferred polarity of operation indicated for each type. Reversing the polarity will, in general, damage the device. For all types described herein, the heat sink must be the negative electrode (cathode).
- Since the threshold current varies inversely as absolute temperature, the power supply should be rated to deliver the threshold current at the lowest operating case temperature.
- Referring to the power output vs. bias voltage curve, Figure 2, there are 4 things a circuit engineer should be concerned with; the peak power, the power peak voltage, the turn-on voltage, and the shape of the curve. Turn-On Voltage, V_{TO} , is defined as the voltage at which a single frequency (close to the desired frequency) output is obtained from the Gunn oscillator as the power supply voltage is increased from zero to the desired operating voltage. (See Figure 1.)

Figure 1 Typical MA-49107 Power Out and Frequency Vs. Bias Voltage @ 10.5 GHz and 25°C

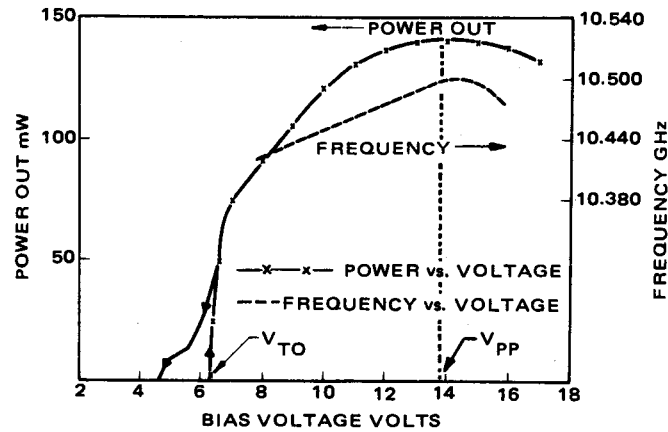

Power peak voltage, V_{PP} , is defined as the voltage at which the power is maximum at 25°C. Both the turn-on voltage and the power peak voltage vary with the operating temperature (see Figure 1). Since the operating voltage usually is fixed in a system application, the variation of the power peak voltage and the turn-on voltage with temperature should be considered for a proper design of the Gunn oscillator.

The turn-on voltage usually increases with decreasing temperature. At low enough temperatures the turn-on voltage could be higher than the operating voltage. Then the Gunn oscillator will have zero output if the bias voltage were to be abruptly or gradually turned on to the desired operating voltage.

Figure 2 Typical Gunn diode Characteristics Vs. Temperature

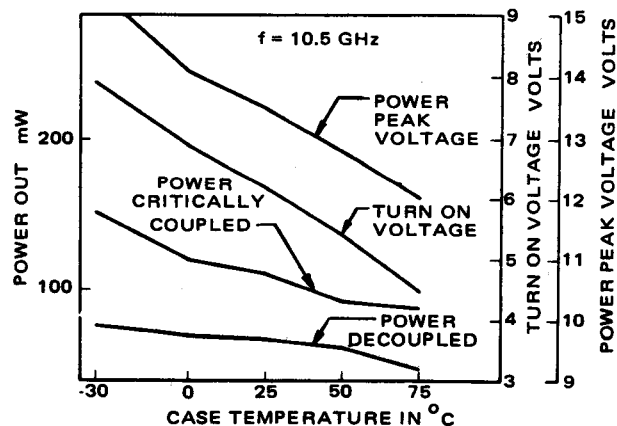

APPLICATION NOTES (Continued)

The turn-on voltage depends not only on the temperature but also on the Gunn diode and the cavity in which the diode is used. To minimize the variation of the turn-on voltage with temperature, it is essential that the oscillator be decoupled from the load. In other words, if the oscillator were to be critically coupled or overcoupled to the load, the turn-on voltage variation would be quite large with temperature. Also, severe moding problems would exist. Usually, we recommend the oscillator be decoupled from the load at least by 2 dB.

Another factor to be considered is the coupling of the diode to the cavity. It is essential that the diode itself is not critically coupled or overcoupled to the cavity.

The shape of the Power-Voltage curve is important. The curve should be smooth and free from discontinuities to assure that the diode is operating at only one frequency and is not moding.

AM Noise

Any power supply has a ripple, however small it may be, associated with the DC output. The AM noise output of the oscillator has two components. The first one is inherently due to the Gunn diode itself. The second one is associated with the bias voltage and the ripple on the power supply. In other words:

AM noise power from the Gunn oscillator

$$= \text{Inherent noise power of Gunn diode} + \frac{dP}{dV} \cdot \Delta V$$

when $\frac{dP}{dV}$ is the slope of the power-bias curve at the operating voltage and a temperature, say T_1 , and ΔV is the bias supply ripple voltage. At a different temperature, the slope of the power-bias curve will be different. If the slope is larger, then the AM noise output will be larger for this same ripple voltage. Conversely, if the slope were smaller, the AM noise output would be lower (assuming, of course, that the inherent noise of the Gunn diode does not change with temperature.)

The criteria for the slope $\frac{dP}{dV}$ is the location of the operating voltage in relation to the power peak voltage. Ideally, the lowest noise will be realized if the operating voltage could be adjusted at any temperature to coincide with the power peak voltage (see Figure 1). (This is because $\frac{dP}{dV} = 0$ at V_{PP}). Often, in low-cost system applications, this luxury is not available. Hence, the operating voltage has to be carefully chosen so that, as temperature changes, the power peak voltage is not located too far from the operating voltage.

Protective Circuit

The Gunn diode has a broad band negative resistance. It is clear from the DC I-V characteristics that a negative resistance exists even at low frequencies. This low frequency negative resistance enables the diode to act as a relaxation oscillator in conjunction with the bias supply leads and any stray capacitance. The frequency of the so-called bias circuit oscillations can extend from a few Hz to a few MHz. The amplitude of the oscillations - especially in high efficiency diodes - can be very high, thus giving rise to a catastrophic failure. Even if the amplitude is not high enough to cause a failure, the RF output is modulated by the bias circuit oscillations. This may manifest itself as AM noise on the microwave output.

The bias circuit oscillations may be suppressed by having a protective circuit similar to the one shown in Figure 3 connected as close to the bias lead of the oscillator as is practical.

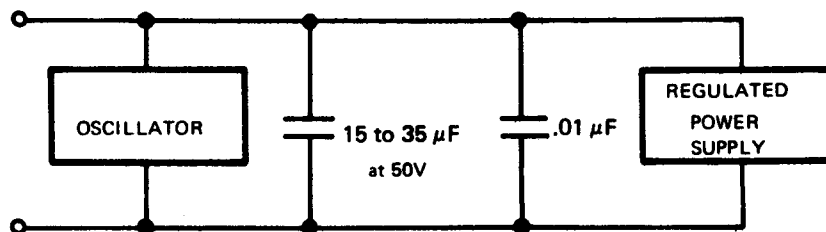

Figure 3 Protective Circuit to Suppress Bias Circuit Oscillations

High Power Gunn Diodes

Bulletin 4550

POWER GENERATION
AND AMPLIFICATION

CW Operation

Pulse Operation

FEATURES

- High output power
- Low AM/FM noise characteristics
- Low thermal resistance
- Unique fabrication method for reliable high power operation

APPLICATIONS

These rugged, reliable, high-power Gunn diodes are ideally suited for use either as locked oscillators or as reflection amplifiers in point-to-point communication links and telemetry systems.

DESCRIPTION

These GaAs Gunn diodes are designed to operate through bulk negative resistance effect and feature low AM and FM noise characteristics. They accomplish a one-step conversion from dc to microwave energy from a single low voltage supply, thereby eliminating complex circuitry.

High Power Gunn Diodes

CW Operation
Pulse Operation

CASE STYLES 111

141

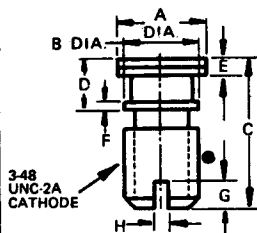

DIM.	INCHES		MM	
	MIN.	MAX.	MIN.	MAX.
A	.119	.127	3.02	3.22
B	.098	.102	2.49	2.59
C	.188	.208	4.78	5.28
D	.057	.071	1.45	1.80
E	.016	.024	0.41	0.61
F	.009	.011	0.23	0.28
G	.030	.040	0.76	1.02
H	.015	.025	0.38	0.64

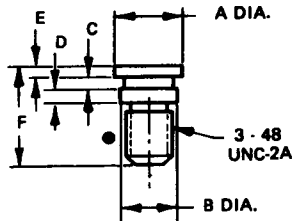

DIM.	INCHES		MM	
	MIN.	MAX.	MIN.	MAX.
A	.165	.165	3.94	4.19
B	.120	.130	3.05	3.30
C	.045 REF.		1.14 REF.	
D	-	.030	-	0.76
E	-	.030	-	0.76
F	.205	.225	5.21	5.72

Not to scale.

NOTE: ● Denotes Cathode (Heat Sink End)

MAXIMUM RATINGS:

Storage Temperature

-60°C to 175°C

Maximum Active Region Temperature

260°C

ENVIRONMENTAL CAPABILITIES

Microwave Associates' high power Gunn diodes are capable of passing the following MIL-STD-750 tests:

	Test Method	Test Condition
High Temperature Storage	1031	1000 hours @ 150°C
Temperature Cycling	1051	5 cycles from -65°C to +150°C
Thermal Shock	1056	5 cycles from 0°C to +100°C
Shock	2016	0.5 ms pulse, 1500 G, 5 shocks each plane
Vibration	2056	50-2000 Hz at 20 G min., 5 shocks each plane
Constant Acceleration	2006	1 min. each (X ₁ , Y ₁ , Y ₂) plane at 20,000 G
Moisture Resistance	1021	+25° to +65°C at 90 to 98% relative humidity for a 10 day period
Leakage	1071	Fine and gross leaks

Electrical Characteristics at 25°C Case Temperature DIODES FOR CW OPERATION

Model Number	Case Style	Frequency Range GHz	Min. Output Power mW	Max. Bias Voltage Volts	Max. Input Power Watts	Max. Threshold Current Amperes	Max. ³ Δ T° C
MA-49139	111	4.0-8.0 ¹	500	14.0	17.0	2.0	185
MA-49110	111	8.0-12.4 ¹	500	12.0	16.5	2.5	185
MA-49145	141	4.4-5.0 ²	1000	15.0	28.0	2.8	185
MA-49146	141	5.9-6.4 ²	1000	14.0	28.0	3.0	185
MA-49147	141	6.5-7.2 ²	1000	14.0	28.0	3.0	185
MA-49148	141	7.1-7.9 ²	1000	14.0	28.0	3.5	185
MA-49183	141	8.0-10.0 ¹	750	12.0	21.0	3.0	185
MA-49184	111	12.4-14.5 ¹	500	10.0	16.5	3.0	185
MA-49185	111	4.4-5.0 ²	500	14.0	17.0	2.0	185
MA-49186	111	5.9-6.4 ²	500	14.0	17.0	2.0	185
MA-49187	111	6.5-7.2 ²	500	14.0	17.0	2.0	185
MA-49188	111	7.1-7.9 ²	500	14.0	17.0	2.0	185
MA-49189	111	10.7-11.7 ²	500	12.0	16.5	2.5	185



MICROWAVE ASSOCIATES, INC. BURLINGTON, MASSACHUSETTS

POWER GENERATION
AND AMPLIFICATION

DIODES FOR PULSE OPERATION

Electrical Characteristics at 25° Case Temperature

Model Number	Package Style	Frequency ⁴ Range GHz	Min. Output Power Watts	Typ. Peak Voltage Volts	Typ. Peak Current Amps	Max. Peak Voltage Volts	Max. Duty Cycle %	Max. Pulse Length μ S
MA-49260	111	5.0-8.0 ¹	5	35	2-3	45	1	1
MA-49265	111	8.0-12.0 ¹	5	25	2-3	35	1	1

NOTES:

1. These diodes will deliver at least the minimum specified output power into a critically coupled load at a customer specified single frequency within the indicated band.
2. These diodes will deliver at least the minimum specified output power into a critically coupled load over the frequency range listed in the specification table.
3. The rise in temperature between the diode stud and the active region is defined to be $\Delta T = (P_{in} - P_{out})$. In actual use, the thermal drop between the ambient and the diode case must be taken into account in order to avoid exceeding the maximum active region temperature of 260° C. The maximum active region temperature may be computed as follows:

Maximum active region temperature = $\theta (P_{in} - P_{out}) + T_A + \Delta T_H$, where T_A = ambient temperature, ΔT_H = temperature drop between the diode case and the ambient.

- In well-designed heat-sinks, the thermal drop, ΔT_H , is usually less than 30° C for a power input of about 15 watts. This is an important factor in the design of Gunn oscillators, and must be carefully considered.
4. Frequency drift during a 0.5 μ S pulse is typically less than 5 MHz in a waveguide cavity.
 5. The technique for measuring thermal resistance θ , is available on request (TM-321).
 6. The diode impedance as an oscillator can be measured; this data up to 9.0 GHz can be supplied for a nominal additional charge. (Refer to Application Notes.) We will be glad to provide, free of charge, open and short-circuited packages of ODS-111 and ODS-141 for customers who would like to measure the package parasitics for reducing the impedance data to the chip terminals.
 7. These high power diodes are normally burnt-in for a minimum period of 48 hours at a diode case temperature (T_c) of $90 \pm 5^\circ$ C and a dc bias voltage of ($V_{op} + 1.0$) volts. For a nominal additional charge, diodes can be burn-in for longer periods as specified by the customer.

RELIABILITY ESTIMATION

Gunn diode MTBF can be established through use of a continuing long term life test. Diodes operating at normal DC bias and a case temperature of 75° C have accumulated at Microwave Associates over 6,000,000 unit hours of operation without failure. An estimate of the minimum MTBF at a 90% confidence level is made by assuming a failure to occur at the present time. Using this technique we estimate the MTBF to be in excess of 200,000 hours with 90% confidence level.

DIODE MOUNTING PROCEDURE

The mount used for the diode must provide an adequate thermal path away from the diode stud. During initial operation it is always advisable to monitor the diode case temperature, (T_c), by means of a thermocouple placed in the screw driver slot or Hex socket at the base of the diode case. As the bias voltage is slowly increased from zero volts, the case temperature should be monitored to ensure adequate heat sinking. As a rule of thumb, the heat sinking is probably adequate if the threshold current measured in the actual oscillator is more than 95% of the threshold current indicated in the accompanying data sheet. (The threshold current is an inverse function of junction temperature). If the junction is too hot because of an inadequate heat sink, the threshold current will decrease to less than 95% of the quoted value. The current through the diode below the threshold is given by:

$$I = \frac{c}{T^a}$$

I = current a = constant depending on material (typically 1.0 - 1.3)
 T = absolute temperature c = a proportionally constant

The current flow is very sensitive to junction temperature.

The diode should be securely tightened into a clean, sharply tapped 3 - 48 UNC 2A threaded hole in the mount. A torque of approximately 6 inch-ounces should be used in tightening the diode, in the 111 package, (10 inch ounces in the 141 package). As an alternative mounting process the diode may be soldered into the mount, using a minimum of clearance for solder between the diode and the mounting hole. The diode and mount should be degreased and tinned with solder before the insertion of the diode. We recommend use of a 60-40 eutectic lead-tin solder with a melting point of $\approx 180^\circ\text{C}$.

TYPICAL COAXIAL OSCILLATOR CAVITY

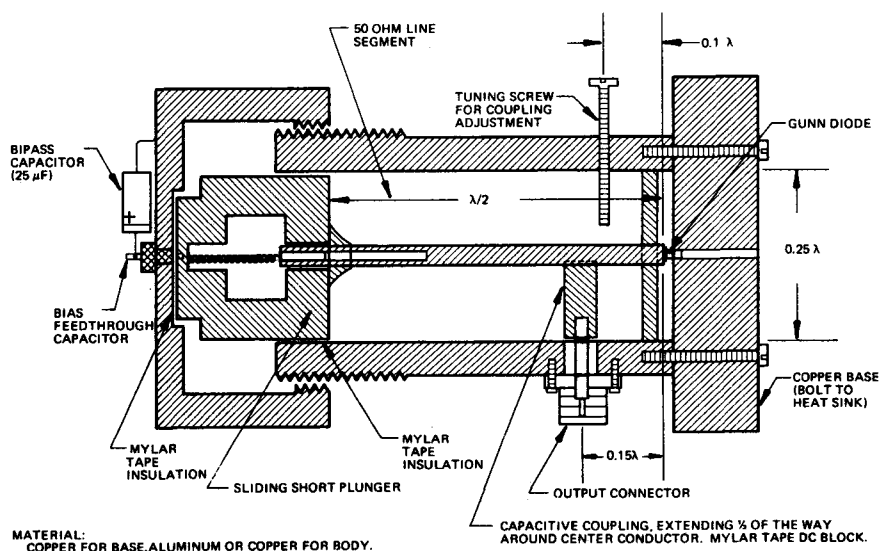

TYPICAL PERFORMANCE CURVES

FIGURE 1 TYPICAL CURRENT VERSUS VOLTAGE CHARACTERISTIC

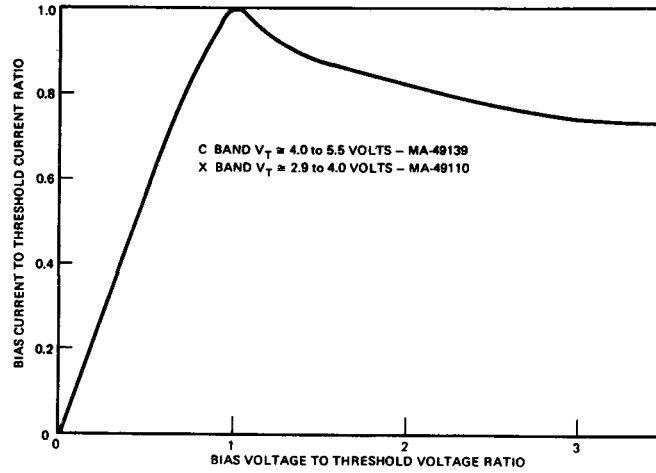

FIGURE 2 TYPICAL OUTPUT POWER VERSUS FREQUENCY
 MA-49110, MA-49145, MA-49146, MA-49147,
 MA-49183

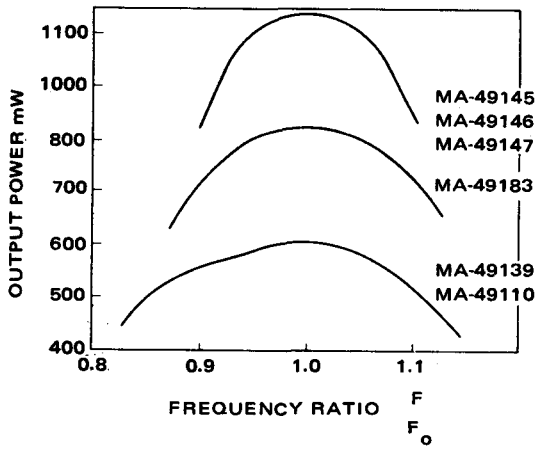

FIGURE 3 TYPICAL OUTPUT POWER VERSUS DIODE CASE TEMPERATURE - MA-49130, MA-49110, MA-49145, MA-49146, MA-49147

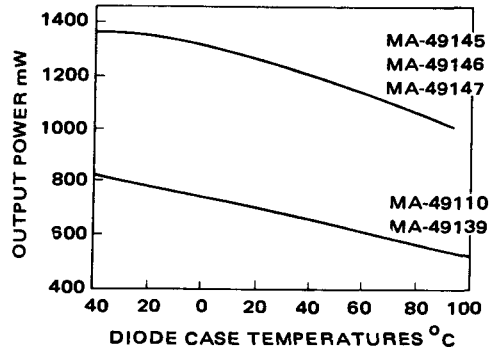

FIGURE 4 TYPICAL FM NOISE SPECTRUM - BW = 100 Hz,
 CAVITY $Q_L = 350$

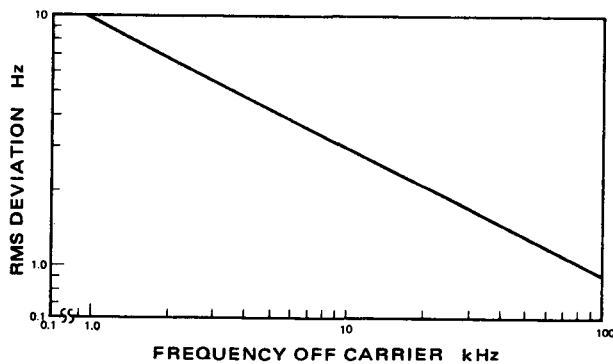
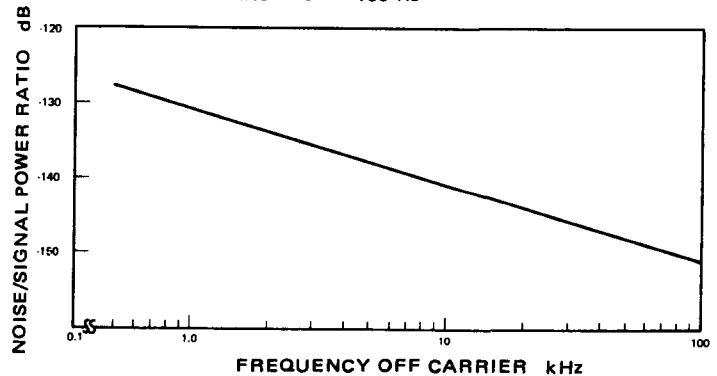
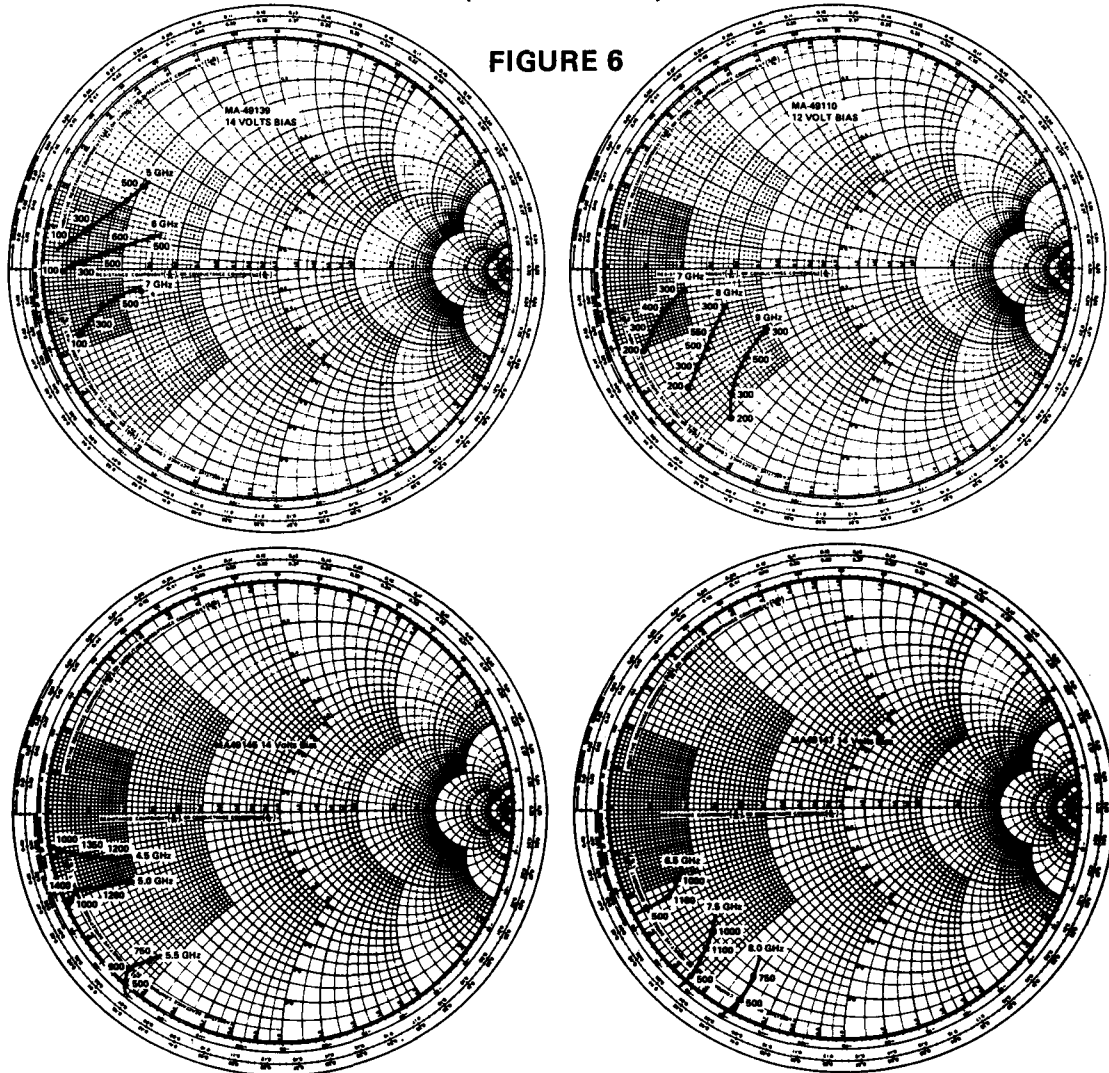

FIGURE 5 TYPICAL AM NOISE SPECTRUM - DOUBLE SIDE BAND - BW = 100 Hz



TYPICAL LOAD IMPEDANCE REQUIRED FOR OSCILLATION AT VARIOUS FREQUENCIES AND POWER LEVELS (MILLIWATTS)

FIGURE 6



AMPLIFIER APPLICATIONS

High power Gunn diodes are ideally suited for use as the transmitter output stage in FM and FDM communication system links. The low noise and long life properties of the Gunn device give it the advantage over IMPATT devices in these applications even though IMPATTs offer higher conversion efficiencies. Most repeater applications involve use of the Gunn device in an injection locked oscillator configuration, where the output frequency of the Gunn oscillator follows the frequency of a small circulator coupled input signal. Gain and bandwidth of such a system are related as follows:

$$\frac{BW}{f_o} = \left(\frac{2}{Q_L} \right) \left(\frac{P_i}{P_o} \right)^{1/2}$$

- Here:
- BW = the locking bandwidth (both sides)
 - f_o = the free running operating frequency
 - Q_L = the loaded Q of the oscillator
 - P_i = the injected power
 - P_o = the free running oscillator power

In practice, up to 20 dB per stage of power gain is feasible with oscillator Q_L as low as 12.

High power Gunn diodes are also available for reflection amplifier service. Here, the diode is operated into a high impedance load such that, in the absence of incoming signal, no oscillations occur. If a small input signal is circulator coupled into the test fixture, it is amplified by triggering oscillations of the Gunn device. In general, gain bandwidth products of 3 GHz per stage are possible.

Specially selected high power gain diodes for reflection amplifier service are supplied with small signal impedance data to aid in amplifier design, and may be specified by adding a suffix A to the appropriate type number.

MA-49000 Series

HIGH FREQUENCY GUNN DIODES

for Communications & Paramp Pump Applications

Bulletin 4508A

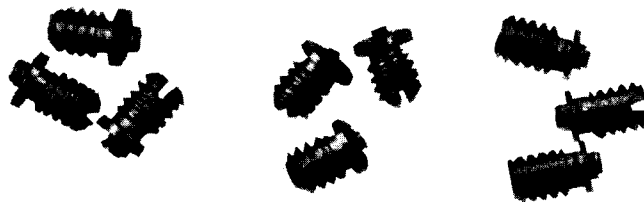

FEATURES

- Low package parasitics
- High output power
- Low noise characteristics
- Good power and frequency stability
- High efficiency
- Reliability suitable for military applications

APPLICATIONS

These reliable diodes are ideally suitable for use as paramp pump sources and as transmitters in secure point-to-point communication links. The noise performance of these diodes is better than that of comparable reflex klystrons. This makes these high power Gunn diodes attractive for use as local oscillators.

DESCRIPTION

These GaAs Gunn diodes are designed to operate through bulk negative resistance effect. They feature low noise characteristics, good efficiency, and a one-step conversion from dc to microwave energy from a single low voltage supply, thereby eliminating complex circuitry.

REVISED SPECIFICATIONS TABLE
Electrical Characteristics at $T_c = 25^\circ\text{C}$

Model Number	Case Style	Frequency Range GHz	Min. CW ¹ Output Power mW	BW %	V_{op} (volts)		I_{op} (mA) Max.	I_T (mA) Max.	$\Delta T^{3,4}$ $^\circ\text{C}$ Max.
					Min.	Max. ²			
MA-49179	118	18-26.5	50	± 5	5.0	8.0	600	1000	85
MA-49179	138	18-26.5	50	± 5	5.0	8.0	600	1000	80
MA-49180	118	18-26.5	100	± 5	5.0	8.0	1000	1600	130
MA-49180	138	18-26.5	100	± 5	5.0	8.0	1000	1600	125
MA-49178	118	18-26.5	250	± 5	5.0	8.0	1600	2500	175
MA-49177	138	26.5-35.0	150	± 5	4.0	8.0	1400	2000	130
MA-49172	138	26.5-40	50	± 5	3.5	6.0	800	1200	75
MA-49173	138	26.5-40	100	± 5	3.5	6.0	1200	1800	115
MA-49181	138	40-50	50	± 5	2.5	4.5	1500	1800	175
MA-49182	138	50-60	50	± 5	2.5	4.5	1500	1800	175

NOTES:

1. The minimum indicated power is guaranteed into a critically coupled load over the indicated bandwidth centered around the frequency specified by the customer. The customer should also specify case style (118 or 138) with the order.
2. The operating voltage, in general, decreases as the center frequency of operation increases.
3. $\Delta T = (P_{in} - P_{out}) \theta$, where θ is the thermal resistance in $^\circ\text{C}/\text{W}$, P_{in} is the power into the diode in watts, P_{out} is the output power & ΔT is the temperature difference between the active region and the case.
4. The technique for measuring thermal resistance is available on request (TM-321).
5. The mount used for the diode must provide an adequate thermal path away from the diode stud. When first using the diode, it is always advisable to ensure adequate heat sinking by monitoring the diode case temperature (T_c) with a thermocouple placed in the screwdriver slot at the base of the stud. The threshold current in the actual oscillator at 25°C should not be less than 95% of the indicated threshold current. The current through the diode below the threshold voltage may be written $I = C/T^a$, where T is the absolute temperature of the junction, a is a material-dependent parameter (whose value usually lies between 0.5 and 1.10), and C is a constant. Since the current is inversely proportional to the junction temperature, the threshold current decreases rather rapidly with increasing temperature.
6. Higher power diodes are available on special request.
7. All diodes are burnt in with a dc bias equal to $V_{op} + 1.0$ Volts, for a minimum period of 24 hours, at a minimum case temperature of 85°C .
8. All the typical performance curves were measured in MA test cavities. Engineering drawings of these test cavities are available on request.
9. Case style 118 and case style 138 are both constructed only of copper. The top lid is soldered on to the ceramic. Extreme care should therefore be taken in soldering any lead to the lid. The temperature of the lid should not exceed 235°C for more than a few seconds during soldering.
10. Case style 148 available on request.

Absolute Maximum Ratings:

Storage Temp:

Max Active Region Temp:

-60°C to $+175^\circ\text{C}$
 260°C

SPECIFICATIONS (Continued)

Environmental Capabilities

Microwave Associates' high-frequency Gunn diodes, for operation in K and V-bands, are capable of passing the following MIL-STD-750 tests:

Test Description	Test Method	Test Condition
High Temperature Storage	1031	1000 hours at 150°C
Temperature Cycling	1051	5 cycles from -65°C to +150°C
Thermal Shock	1056	5 cycles from 0°C to +100°C
Shock	2016	0.5 ms pulse; 1500 G; 5 shocks each plane
Vibration	2056	50-2000 Hz at 20 G min. 5 shocks each plane
Constant Acceleration	2006	1 min. each X ₁ , Y ₁ & Y ₂ at 20,000 G
Leak Tests	1071	Gross leak

OUTLINE DRAWINGS

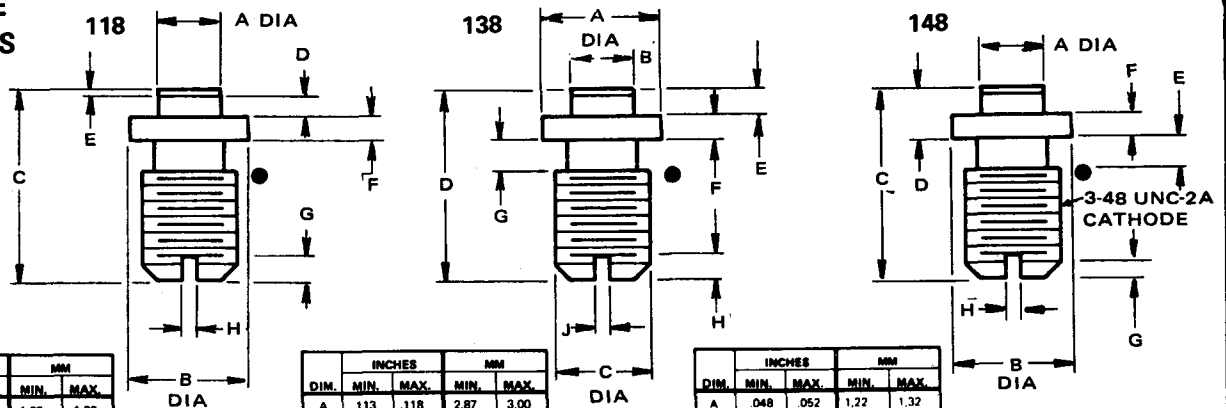

DIM.	INCHES		MM	
	MIN.	MAX.	MIN.	MAX.
A	.048	.052	1.22	1.32
B	.096	.102	2.49	2.59
C	.185	.185	4.19	4.69
D	.014	.018	0.356	0.457
E	.008	.012	0.20	0.31
F	.009	.011	0.23	0.28
G	.030	.040	0.76	1.02
H	.015	.025	0.38	0.64

NOT TO SCALE.

DIM.	INCHES		MM	
	MIN.	MAX.	MIN.	MAX.
A	.113	.118	2.87	3.00
B	.027	.034	0.69	0.86
C	.068	.070	1.73	1.78
D	.140	.145	3.56	3.68
E	.018	.019	0.41	0.48
F	.018	.022	0.46	0.56
G	.015	.025	0.38	0.64
H	.030	.040	0.76	1.02
J	.015	.025	0.38	0.64

DIM.	INCHES		MM	
	MIN.	MAX.	MIN.	MAX.
A	.048	.052	1.22	1.32
B	.113	.118	2.87	3.00
C	.187	.187	4.24	4.74
D	.040	.052	1.01	1.32
E	.025	.035	0.63	0.88
F	.018	.022	0.45	0.55
G	.035	.045	0.64	0.11
H	.015	.025	0.38	0.63

● Denotes Cathode (Heat Sink End)

MILLIMETER DIODE TEST FIXTURE

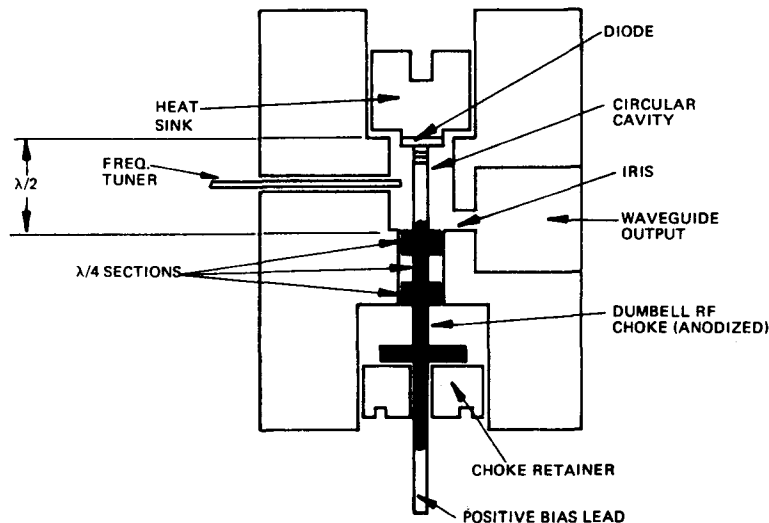

TYPICAL PERFORMANCE CURVES

FIGURE 1 TYPICAL FREQUENCY VARIATION WITH VOLTAGE AT 28 GHz AT 50°C

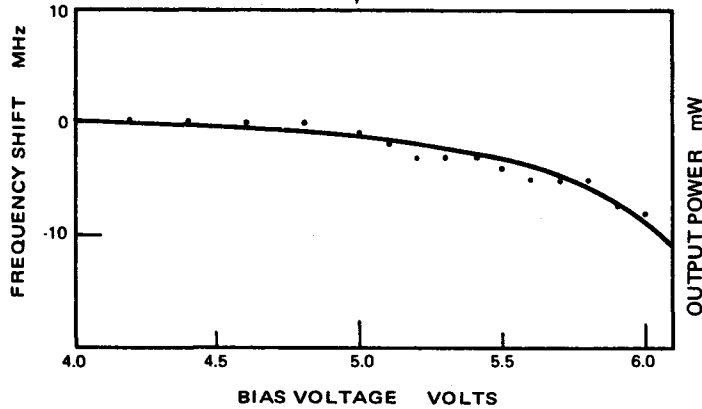

FIGURE 2 TYPICAL OUTPUT POWER VS. BIAS VOLTAGE AT 28 GHz

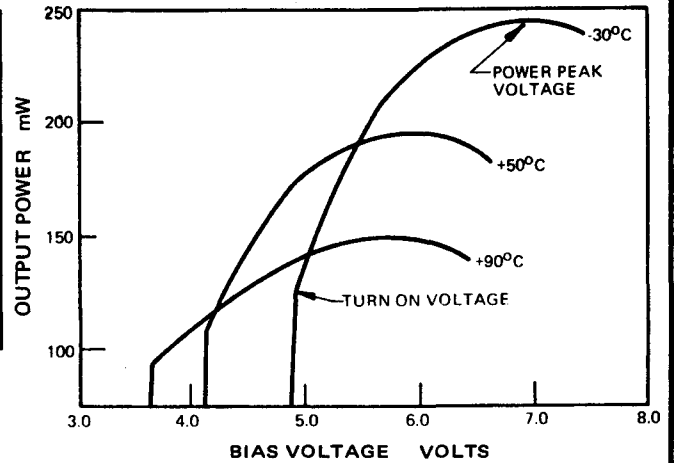
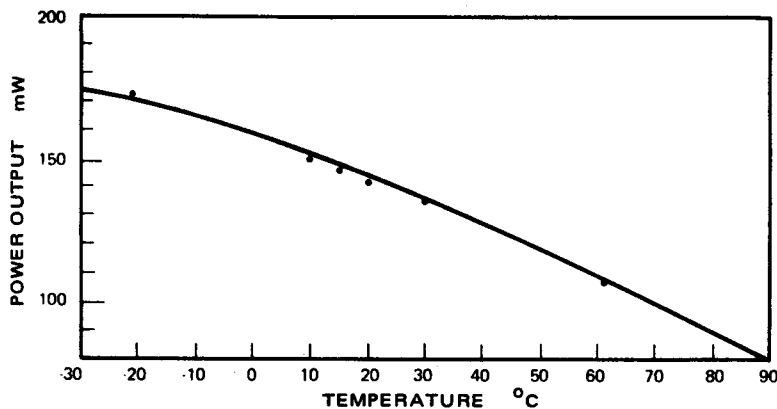

FIGURE 3 TYPICAL OUTPUT POWER VS. TEMPERATURE AT 40 GHz



APPLICATION NOTES

The power output vs. bias voltage curve (Figure 2) illustrates that there are four things a circuit engineer should be concerned with; the peak power, the peak power voltage, the turn-on voltage, and the shape of the curve.

In general, a Gunn diode should be operated at about 10% less than power peak voltage at 25°C. This is to improve the power stability. As the chip temperature rises, the peak output power and the peak power voltage of the diode decrease. If the diode is operated at less than the room temperature power peak voltage, the drop in power due to the rise in chip temperature will be partially compensated for by the diode operating closer to power peak voltage. The operating voltage that is usually chosen is the power peak voltage at the maximum temperature the diode will see.

The turn-on voltage determines the lower limit of the operating voltage. To ensure cold temperature starting, the diode is generally biased at least 10% higher than the room temperature turn-on voltage. This is because the turn-on voltage increases as the diode temperature decreases.

The shape of the Power-Voltage curve is important. The curve should be smooth and free from discontinuities to assure that the diode is operating at only one frequency and is not moding.

Multiplier Varactors

Bulletin 4450

POWER GENERATION
AND AMPLIFICATION

Silicon, Multiplier Varactors

GaAs, Multiplier Varactors

Silicon

Multiplier Varactors

The MA-44100 Series — SNAP™ Varactor

The MA-44200 Series — DUALMODE™ Varactor

The MA-43000 Series — RF Circuit Tested SNAP™ Varactor

The MA-44000 Series — POWERPACK™ Stacked Multiplier Varactor

DESCRIPTION

Microwave Associates manufactures four distinct families of silicon multiplier varactor diodes. Each series has an advantage in a particular type of circuit. All of the varactors in these series are manufactured with an "oxide passivated metalized mesa" process. This process results in a device with extremely low leakage current and excellent reliability. This reliability has been demonstrated on many high reliability programs.

The diffusion profile of each family is carefully controlled to assure closely matched impedances and stored charge characteristics. Control of these characteristics is assured by tight double-ended specifications for lifetime, capacitance and breakdown voltage. All of the varactors are eutectically bonded to assure low thermal resistance.

APPLICATIONS

These varactors are intended for use in high power frequency multiplier circuits, harmonic generators, signal sources, and other signal processing applications.

ABSOLUTE MAXIMUM RATINGS (ALL DEVICES)

Temperature Range:

Operating Temperature —65 to +150°C

Storage Temperature —65 to +150°C

ELECTRICAL SPECIFICATIONS @ T_A = 25°C

SNAP Varactors

Model Number	Case Style	Breakdown ¹ Voltage		Junct. Capac. @ -6V		Max. Ratio		Minority Carrier Lifetime		Max. Snap Time	Max. Thermal Resist. °C/W	Suggested Output Range GHz	Typical ² Efficiency as Tripler %
		Min.	Max.	Min.	Max.	Min.	Max.	Min.	Max.				
MA-44100	43	150	250	16.0	30.0	1.4	1000	3000	3000	5	0.1-1	65	
MA-44110	43	100	150	8.0	16.0	1.4	350	1050	750	10	0.5-1	65	
MA-44120	43	75	100	3.0	8.0	1.4	150	450	500	15	0.5-2	60	
MA-44130	30	45	75	1.0	3.5	1.5	60	200	200	25	2.0-6	60	
MA-44140	30	25	45	0.5	1.5	1.5	10	30	100	70	4.0-12	60	
MA-44150	30	15	40	0.2	0.6	1.5	8	30	90	100	8.0-16	50	
MA-44300	26	50	—	3.0	5.0	—	100	—	225	300	0.1-1	60	
MA-44310	26	35	—	1.0	3.0	—	30	—	200	300	0.5-3	60	
MA-44320	54	15	—	0.5	1.0	—	10	—	90	600	1.0-6	60	

Circuit Tested SNAP Varactors

Model Number	Case Style	Min. Output		F _{in} GHz	Max. Input Power Watts	Breakdown ¹ Voltage		Junct. Capac. @ -6V		Minority Carrier Lifetime		Max. Snap Time pS	Max. Thermal Resist. °C/W
		Power Watts	F _{out} GHz			Min.	Max.	Min.	Max.	Min.	Max.		
MA-4B300	43	8.0	2.0	0.4	30	100	145	5.0	8.0 ³	300	900	750	7
MA-43000	103	4.0	2.0	0.333	15	85	105	3.0	4.5	250	500	600	12
MA-43002	91	1.5	6.0	2.0	5	45	70	1.6	2.4	75	225	250	25
MA-43004	91	0.30	13.0	3.3	2	30	45	0.45	0.85	20	50	150	45



MICROWAVE ASSOCIATES, INC. BURLINGTON, MASSACHUSETTS

High Order SNAP Varactors for Comb Generators

Model Number	Case ⁵ Style	Breakdown ¹ Voltage		Junct. Capac. @ -6V		Minority Carrier Lifetime		Max. Snap Time pS	Max. Thermal Resist. °C/W	Suggested Output Freq. Range GHz
		Min. Volts	Max. Volts	Min. pF	Max. pF	Min. nS	Max. nS			
MA-43592	30	25	40	.20	.30	9	27	90	.70	1-12
MA-43543	93	20	50	.20 ⁴	.55 ⁴	10	25	60	125	1-20

DUALMODE Varactors

Model Number	Case Style	Breakdown ¹ Voltage		Junct. Capac. @ -6V		Minority Carrier Lifetime		Max. Snap Time pS	Max. Thermal Resist. °C/W	Suggested Output Freq. Range GHz	Typical ² Efficiency as Tripler %
		Min. Volts	Max. Volts	Min. pF	Max. pF	Min. nS	Max. nS				
MA-44200	43	150	250	16	30	1.4	300 1000 3000	5	0.1- 0.5	65	
MA-44210	43	100	150	8.0	16	1.4	100 300 750	10	0.5- 1.0	65	
MA-44220	43	75	100	3.0	8.0	1.4	50 150 500	15	1.0- 2.0	65	
MA-44230	30	45	75	1.0	3.5	1.4	20 60 200	25	2.0- 6.0	55	
MA-44240	30	25	45	0.5	1.5	1.4	10 30 100	70	6.0-12.0	50	
MA-44250	30	15	40	0.2	0.6	1.4	8 30 90	100	10.0-12.0	40	

MULTICHIP VARACTORS For Higher Power Applications

Model Number	Case Style	Min. ¹ Break-down Voltage	Junct. Capac. @ -6V		Minority Carrier Lifetime		Max. Snap Time pS	Max. Thermal Resist. °C/W	Suggested Output Freq. Range GHz	Typical ² Efficiency as Tripler %	Number of Chips
			Min. Volts	Max. Volts	Min. pF	Max. pF					
MA-44051	56	80	0.8	1.6	40	120	120	15	2-6	55	3
MA-44052	56	120	1.6	3.0	80	240	220	7.5	1-3	60	3
MA-44053	56	175	4.0	6.0	90	500	500	5	5-2	60	3
MA-44070	30	60	0.3	0.7	15	50	100	20	8-14	40	2
MA-44071	111	60	0.3	0.7	15	50	100	20	8-14	40	2
MA-44060	30	80	0.7	1.2	40	120	180	15	3-8	50	2
MA-44061	111	80	0.7	1.2	40	120	180	15	3-8	50	2
MA-44050	30	100	1.2	1.6	60	180	200	12	2-6	55	2
MA-44058	111	100	1.2	1.6	60	180	200	12	2-6	55	2

POWERPACK STACKED VARACTORS

Model Number	Case Style	Min. ¹ Break-down Voltage	Junct. Capac. @ -12V		Minority Carrier Lifetime		Max. Snap Time pS	Max. Thermal Resist. °C/W	Suggested Output Freq. Range GHz	Typical ² Efficiency as Tripler %
			Min. Volts	Max. Volts	Min. pF	Max. pF				
MA-44010	122	120	1.6	2.5	80	240	220	7	1-3	65
MA-44020	122	100	1.2	1.6	60	180	200	12	2-6	60
MA-44030	122	80	0.7	1.2	40	120	180	15	3-8	55
MA-44040	122	60	0.3	0.7	15	50	100	20	8-14	40

VARACTOR CHIPS⁶

Snap Chips

Chip Model Number	Chip Style	Packaged Diode Model Number	Suggested Output Freq. Range GHz	Junct. Capac. @ -6V pF		Breakdown ¹ Voltage Volts	
				Min.	Max.	Min.	Max.
MA-43030	132	MA-43000	1-3	3.0	4.5	85	105
MA-43031	132	MA-43002	3-7	1.6	2.4	45	70
MA-43032	134	MA-43004	7-12	0.45	0.85	30	45
MA-43033	134	MA-43592	10-20	0.20	0.30	25	40

Dualmode Chips

Chip Model Number	Chip Style	Packaged Diode Model Number	Suggested Output Freq. Range GHz	Min. Junction Capac. @ -6V pF	Max. Junction Capac. @ -6V pF	Min. Breakdown Voltage Volts	Max. Breakdown Voltage Volts
MA-43034	132	MA-44220	1-3	3.0	8.0	75	100
MA-43035	132	MA-44230	2-6	1.0	3.5	45	75
MA-43036	134	MA-44240	6-12	0.5	1.5	25	45
MA-43037	134	MA-44250	10-20	0.2	0.6	15	40

NOTES:

- Breakdown Voltage is measured at $-10 \mu\text{A}$.
- Doubler efficiencies are typically 5-20% greater than Tripler efficiencies. Quadruplers, typically 10% less than Triplers.
- Junction Capacitance measured at -60V .
- Junction Capacitance measured at 0V .
- Also available in non-magnetic package for YIG tuned comb generators.
- Detailed electrical specifications for these diodes are listed under the packaged diode type number. Only capacitance and breakdown are measured on unpackaged diodes. Capacitance Ratio is C_{TO}/C_{T-6} .

CASE STYLES

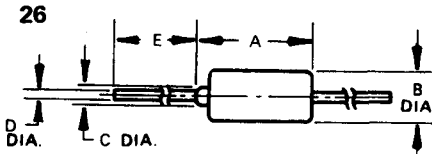

TYPICAL
 $L_p = 2.0\text{ nH}$
 $C_p = .2\text{ pF}$

DIM.	INCHES		MM	
	MIN.	MAX.	MIN.	MAX.
A	-	.300	-	7.62
B	-	.105	-	2.67
C	.040	REF.	1.016	REF.
D	.018	.022	0.457	0.559
E	1.000	-	25.40	-

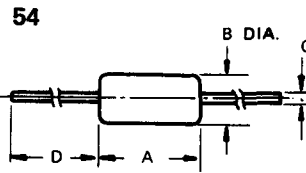

TYPICAL
 $L_p = 2.5\text{ nH}$
 $C_p = .05\text{ pF}$

DIM.	INCHES		MM	
	MIN.	MAX.	MIN.	MAX.
A	.145	.185	3.68	4.19
B	.068	.075	1.72	1.91
C	.014	.016	0.35	0.41
D	1.000	1.500	25.4	38.1

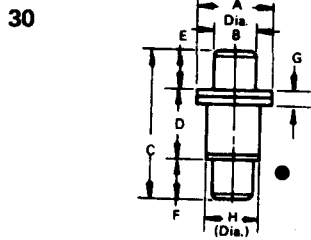

TYPICAL
 $L_p = .40\text{ nH}$
 $C_p = .18\text{ pF}$

DIM.	INCHES		MM	
	MIN.	MAX.	MIN.	MAX.
A	.119	.127	3.02	3.23
B	.060	.064	1.52	1.63
C	.205	.225	5.21	5.72
D	.085	.097	2.16	2.46
E	.060	.064	1.52	1.63
F	.060	.064	1.52	1.63
G	.016	.024	0.41	0.61
H	.079	.083	2.01	2.11

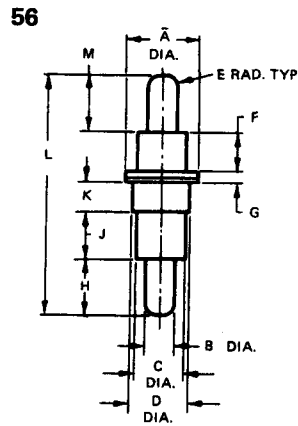

TYPICAL
 $L_p = 3.0\text{ nH}$
 $C_p = .35\text{ pF}$

DIM.	INCHES		MM	
	MIN.	MAX.	MIN.	MAX.
A	-	.240	-	6.10
B	.092	.094	2.34	2.39
C	.156	.165	3.94	4.19
D	.185	.195	4.70	4.95
E	.030	.046	0.76	1.17
F	.130	REF.	3.30	REF.
G	-	.030	-	0.76
H	.180	.190	4.57	4.83
J	.145	.155	3.68	3.94
K	.095	.105	2.41	2.67
L	.766	.782	19.46	20.12
M	.180	.190	4.57	4.83

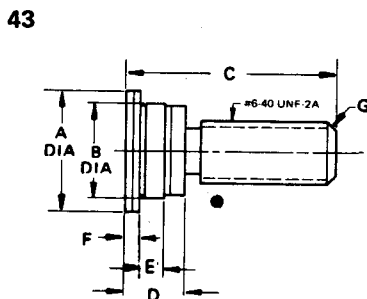

TYPICAL
 $L_p = .6\text{ nH}$
 $C_p = .75\text{ pF}$

DIM.	INCHES		MM	
	MIN.	MAX.	MIN.	MAX.
A	.255	.265	6.5	6.75
B	.208	.212	5.3	5.4
C	.440	.460	11.18	11.70
D	.119	.131	3.03	3.302
E	.050	REF.	1.27	REF.
F	.025	.035	0.635	0.900
G	.020-.45	REF.	0.508-.45	REF.

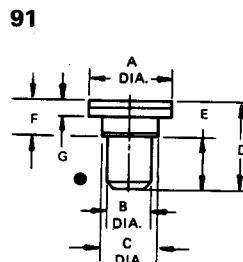

TYPICAL
 $L_p = .3\text{ nH}$
 $C_p = .30\text{ pF}$

DIM.	INCHES		MM	
	MIN.	MAX.	MIN.	MAX.
A	.119	.127	3.02	3.23
B	.060	.062	1.52	1.57
C	.077	.083	1.96	2.11
D	.115	.129	2.92	3.26
E	.060	.064	1.52	1.63
F	.055	.065	1.40	1.65
G	.016	.024	0.41	0.61

● Denotes Cathode End.

Not to scale.

CASE STYLES—(Continued)

93

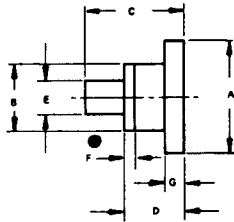

TYPICAL
 $L_p = .12 \text{ nH}$
 $C_p = .15 \text{ pF}$

DIM.	INCHES		MM	
	MIN.	MAX.	MIN.	MAX.
A	.059	.069	1.50	1.75
B	.047	.053	1.19	1.35
C	.070	.080	1.78	2.03
D	.040	.050	1.02	1.27
E	.024	.026	0.61	0.66
F	.004	.010	0.10	0.25
G	-	.015	-	0.38

122

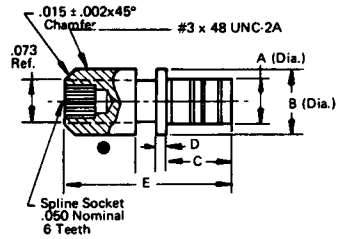

TYPICAL
 $L_p = .4 \text{ nH}$
 $C_p = .4 \text{ pF}$

DIM.	INCHES		MM	
	MIN.	MAX.	MIN.	MAX.
A	.075	.085	1.90	2.16
B	.095	.105	2.41	2.68
C	.096	.128	2.44	3.25
D	.008	.012	0.202	0.304
E	.241	.281	6.12	7.14

103

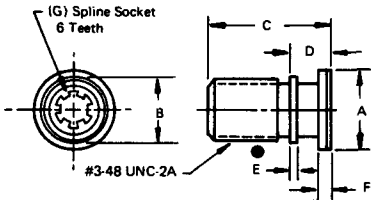

TYPICAL
 $L_p = .3 \text{ nH}$
 $C_p = .27 \text{ pF}$

DIM.	INCHES		MM	
	MIN.	MAX.	MIN.	MAX.
A	.119	.127	3.03	3.25
B	.098	.102	2.5	2.6
C	.188	.208	4.8	5.3
D	.058	.071	1.5	1.8
E	.009	.011	0.25	0.28
F	.016	.024	0.40	0.60
G	.050	NOM.	1.27	NOM.

132

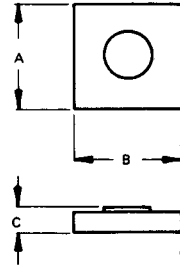

DIM.	INCHES		MM	
	MIN.	MAX.	MIN.	MAX.
A	.020	.024	0.508	0.609
B	.020	.024	0.508	0.609
C	.003	.006	0.076	0.152

111

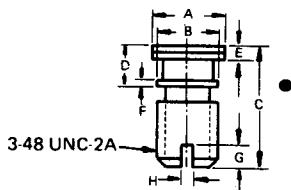

TYPICAL
 $L_p = .30 \text{ nH}$
 $C_p = .27 \text{ pF}$

DIM.	INCHES		MM	
	MIN.	MAX.	MIN.	MAX.
A	.119	.127	3.02	3.22
B	.098	.102	2.49	2.59
C	.188	.208	4.78	5.28
D	.057	.071	1.45	1.80
E	.016	.024	0.41	0.61
F	.009	.011	0.23	0.28
G	.030	.040	0.76	1.02
H	.015	.025	0.38	0.64

134

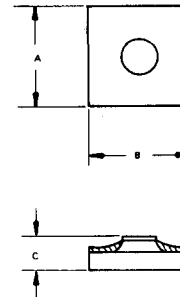

DIM.	INCHES		MM	
	MIN.	MAX.	MIN.	MAX.
A	.0135	.0165	0.3429	0.4191
B	.0135	.0165	0.3429	0.4191
C	.0035	.0065	0.0889	0.1651

NOTE: ● Denotes Cathode.

HOW TO SELECT SILICON MULTIPLIER VARACTORS FOR HARMONIC GENERATION

When selecting a diode for a multiplier circuit, the following constants exist:

- Input frequency
- Output frequency
- Bandwidth
- Required power
- Circuit media – coaxial, stripline or waveguide

The choice of using a SNAP or DUALMODE varactor depends on the results required.

SNAP Varactors

1. High Efficiency
2. Narrow Bandwidth
3. Both Low and High Order Multipliers
4. Comb generators

A SNAP varactor is an epitaxial diffused varactor designed to store charge when conducting in the forward direction. It conducts for a short time under reverse bias until this charge is swept out by the drive. Then the conduction ceases very abruptly. The lifetime is a measure of the time the diode will store charge, and the snap time, the speed at which reverse conduction ceases.

In general, SNAP varactors have very little capacitance change at reverse biases beyond zero bias.

DUALMODE Varactor

The DUALMODE varactor is designed for low order broadband (10-20%) multipliers (times 2 to times 4). It also works well in low order, high power, narrow band multipliers. It is inferior in high order multiplication (more than times 4). It differs principally from the SNAP diode in having a capacitance change of approximately 1.5:1 between zero bias and -6 volts. In general, the large signal series resistance at a few volts can be somewhat lower than a SNAP diode. Selection of the DUALMODE diode should be made in the same manner except that the bias resistor should be approximately double that used with a similar SNAP varactor at the same multiplication ratio. SNAP and DUALMODE varactors usually are not interchangeable in the same circuit because of their different large signal impedances. In general DUALMODE varactors require idler circuits while SNAP diodes do not.

HOW TO SELECT A MULTIPLIER VARACTOR

The important parameters to optimize are listed below in the usual order of selection:

Capacitance – C_T

The capacitive reactance of the diode at the operating bias should be a minimum of 30 ohms and preferably 60 ohms at the output frequency. Special circuits can be used with lower reactances but in general efficiency will suffer.

An additional constraint is imposed because this capacitance must be compatible with the required diode thermal impedance. The thermal resistance is an inverse function of the capacitance.

MULTIPLIER VARACTOR CAPACITIVE REACTANCE VS. FREQUENCY

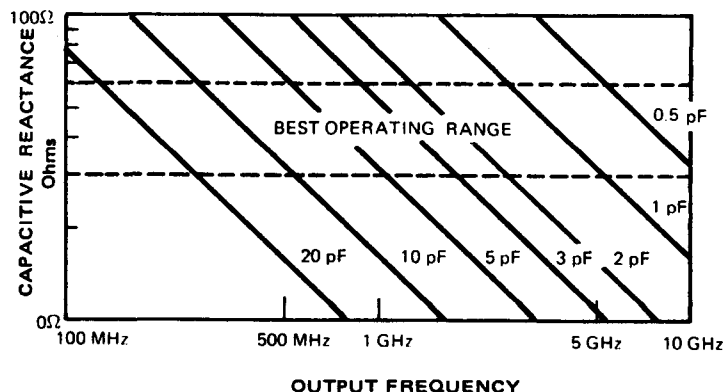

HOW TO SELECT A SILICON MULTIPLIER VARACTOR (Continued)

Snap Time — T_s

The snap time or transition time is the time for the diode to switch from a conducting to a non-conducting state. The snap time should be less than the reciprocal of the output frequency.

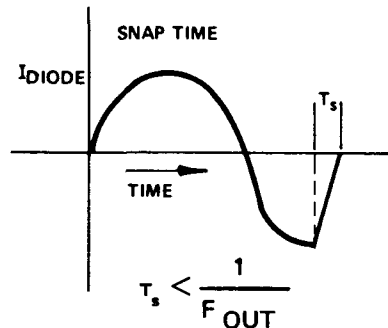

Lifetime — T_L

The lifetime is a measure of the time required for stored charge to be recovered. It must be long enough for the diode to permit RF current to reach a negative peak before it snaps.

The lifetime of a diode should be a minimum of 10 times $1/F_{IN}$

$T_L \geq 10/F_{IN}$ and $\frac{20 \text{ to } 30}{F_{IN}}$ is a better choice.

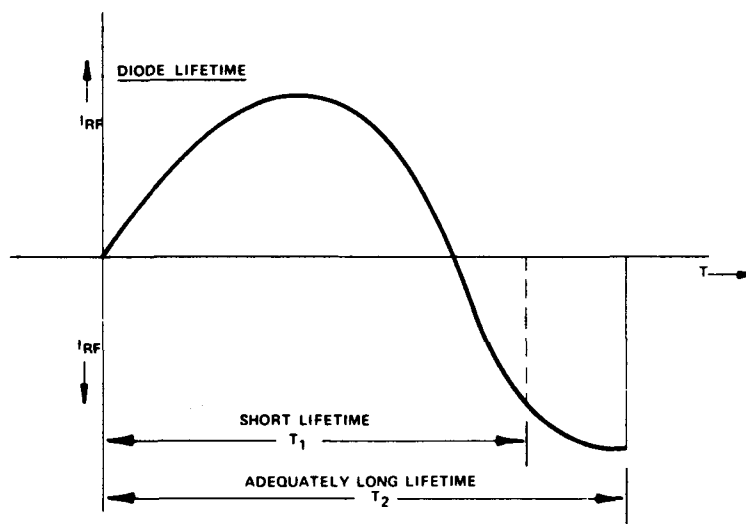

Package Parasitics — L_p, C_p

The diode package parasitics should be small enough such that the series and parallel resonances will be well above the maximum operating frequency.

Thermal Resistance — θ_{JC}

The thermal resistance of the diode must be small enough to allow the diode to remain within the maximum allowable operating temperature. It must be commensurate with the power to be dissipated, i.e.

$$\theta_{JC} = \frac{T_{\text{diode max.}} - T_A}{P_{\text{Diss.}}}$$

Where: θ_{JC} = Thermal Resistance ($^{\circ}\text{C}/\text{W}$)

$T_{\text{diode max.}}$ = Max. allowable diode temperature ($^{\circ}\text{C}$)

T_A = Heat sink maximum temperature ($^{\circ}\text{C}$)

$P_{\text{Diss.}}$ = Power dissipated in the diode under worst case — (Power in — Power out) (Watts)

HOW TO SELECT A SILICON MULTIPLIER VARACTOR (Continued)

Breakdown Voltage — V_B

The minimum required breakdown voltage of the varactor can be obtained by:

$$V_B = K \sqrt{\frac{2 P_o}{F_{in} C_{TR}}}$$

P_o = Power out at F_{out} — in Watts

F_{in} = Input frequency in hertz

C_{TR} = Total capacitance in Farads @ -6 Volts

$K = 0.8$ for $N \leq 4$

$K = 1.5$ for $N > 4$

Bias Resistor Selection — R_b

The bias resistor for a SNAP and DUALMODE varactor can be calculated by:

SNAP Varactors

$$R_b = \frac{5 T_L}{N^2 C_{TR}}$$

DUALMODE Varactors

$$R_b = \frac{10 T_L}{N^2 C_{TR}}$$

Where: T_L = Lifetime (Seconds)

N = Order of Multiplication

C_{TR} = Total Capacitance @ -6 Volts (Farade)

BEST CHOICE OF VARACTOR BY TYPE OF SOURCE

BEST DIODE FOR APPLICATION	HIGH ORDER MULTIPLIER COMB GENERATORS (X 4 OR GREATER)	BROAD BAND MULTIPLICATION (X 4 MAX)	HIGH POWER LOW ORDER (LESS THAN X 4 MAX)	HIGH POWER HIGH FREQUENCY	UPCONVERTERS OR DEMODULATORS	GUARANTEED CIRCUIT PERFORMANCE
SNAP MA-44100 SERIES	X		X			
DUALMODE MA-44200 SERIES		X	X		X	
RF CIRCUIT TESTED SNAP MA-43000 SERIES	X		X			X
POWER PACK SERIES STACKED VARACTOR MA-44000 SERIES				ABOVE 4 GHz X		

TYPICAL PERFORMANCE CURVES

MA-43000

TYPICAL OUTPUT POWER vs. INPUT POWER IN A X10 MULTIPLIER

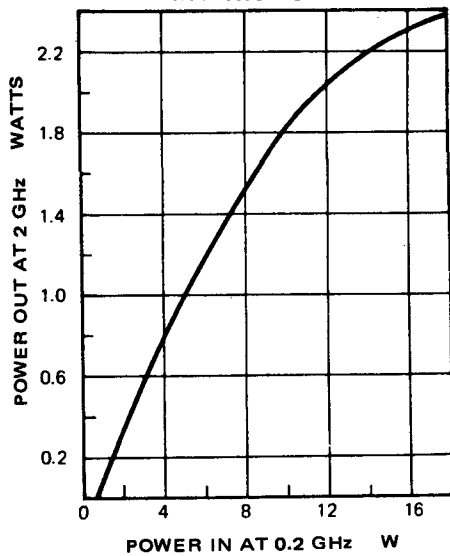

MA-43002

OUTPUT POWER AT 6 GHz vs. INPUT POWER IN X3 MULTIPLIER

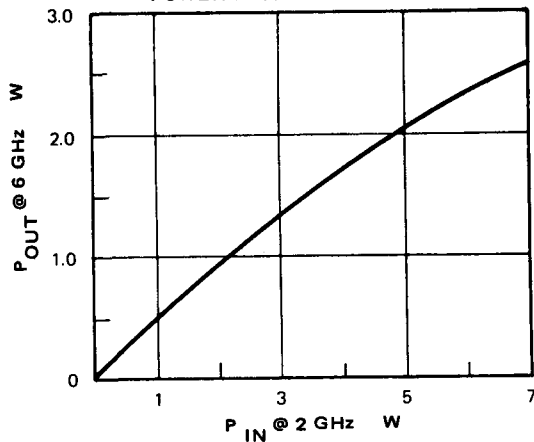

TYPICAL CAPACITANCE vs. REVERSE VOLTAGE AT 25°C FOR THE MA-43002

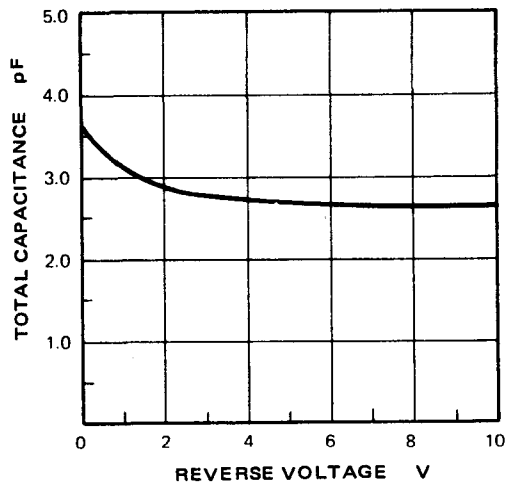

MA-43000
PER CENT CAPACITANCE CHANGE vs. TEMPERATURE

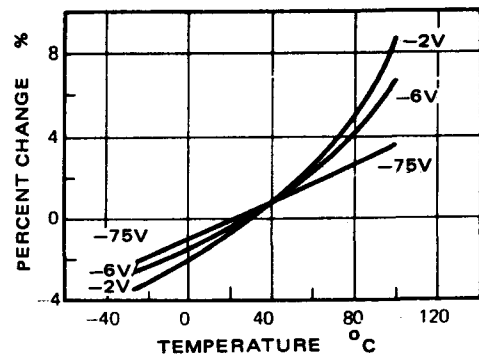

MA-43002
PER CENT CHANGE IN JUNCTION CAPACITANCE vs. TEMPERATURE

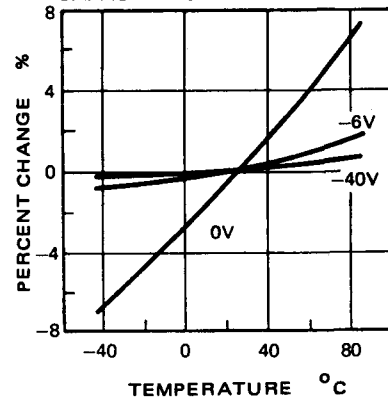

MA-43002
PER CENT CHANGE IN LIFETIME vs. FORWARD CURRENT

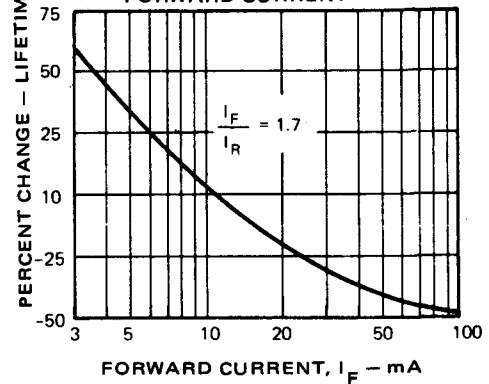

MA-43002

PER CENT CHANGE IN LIFETIME vs. TEMPERATURE

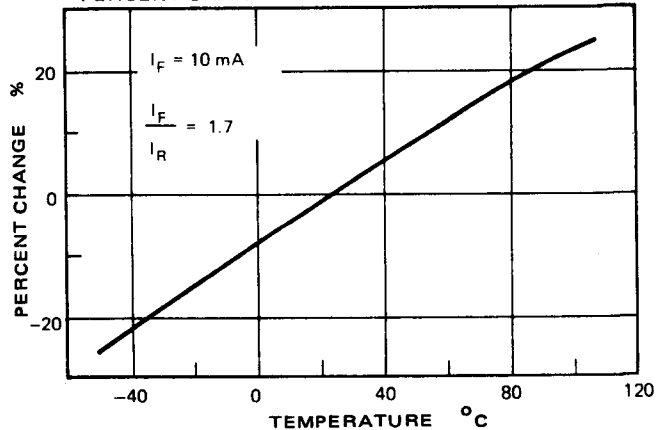

TYPICAL PERFORMANCE CURVES (Continued)

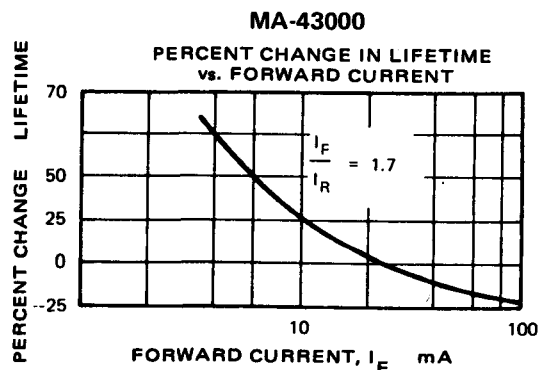
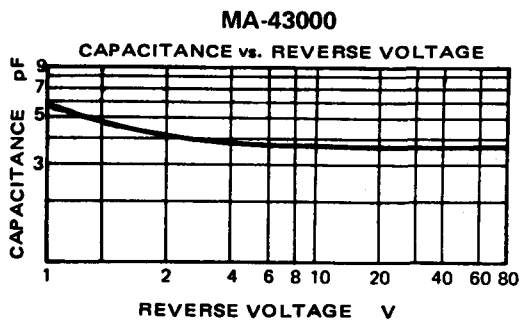
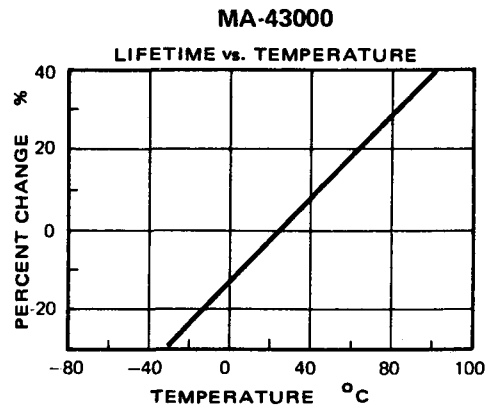
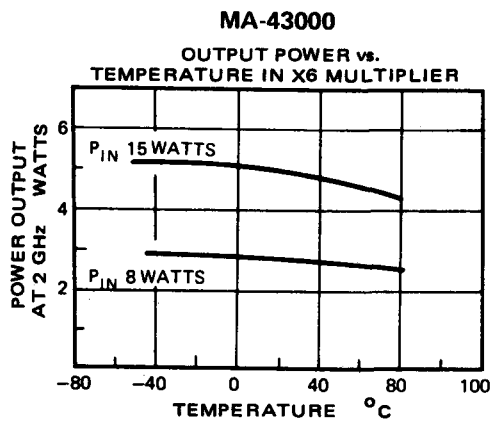
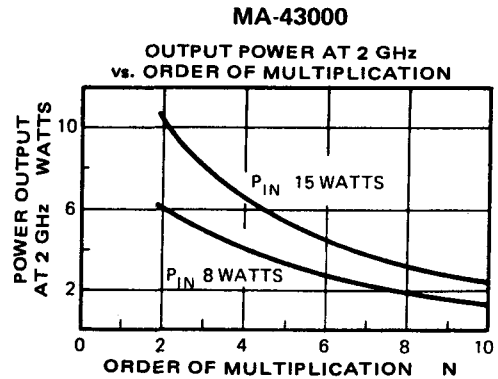
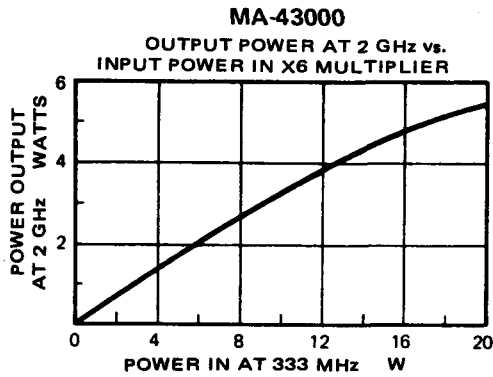
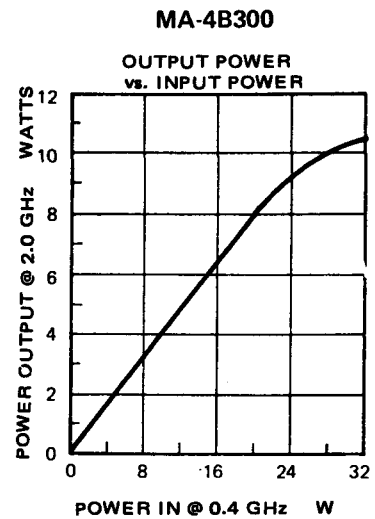
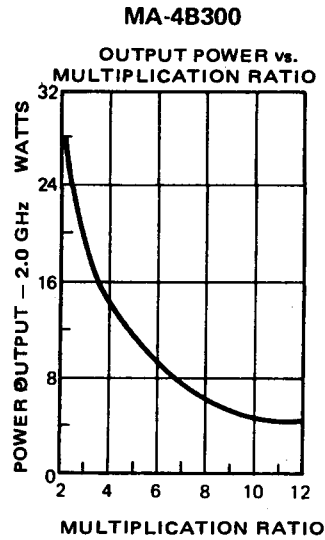
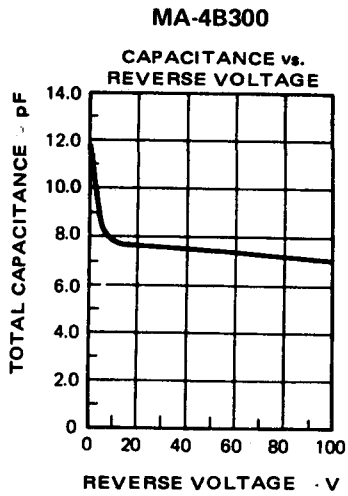

TYPICAL PERFORMANCE CURVES (Continued)

MA-43004
TYPICAL OUTPUT POWER vs. INPUT POWER IN A X5 MULTIPLIER

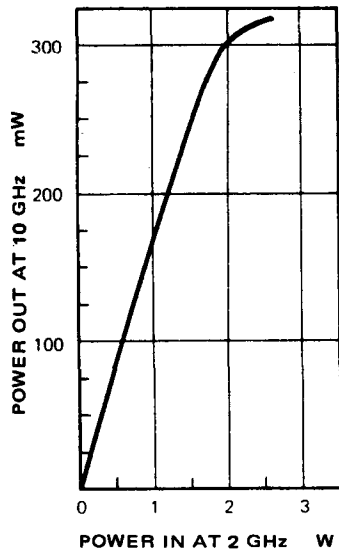

MA-43004
TYPICAL CAPACITANCE vs. REVERSE VOLTAGE AT 25°C

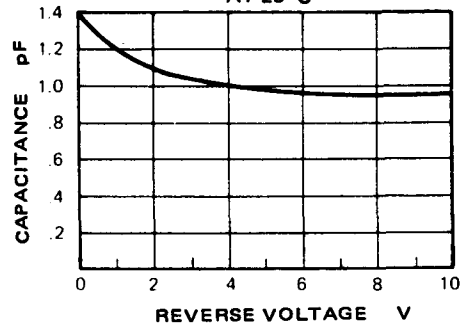

MA-43004
OUTPUT POWER AT 13.3 GHz vs. ORDER OF MULTIPLICATION

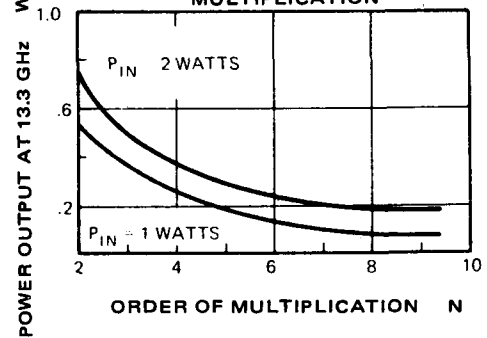

MA-43004
LIFETIME vs. TEMPERATURE

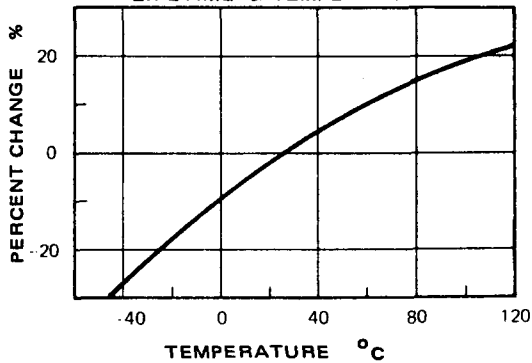

MA-43004
OUTPUT POWER AT 13.3 GHz vs. INPUT POWER IN X4 MULTIPLIER

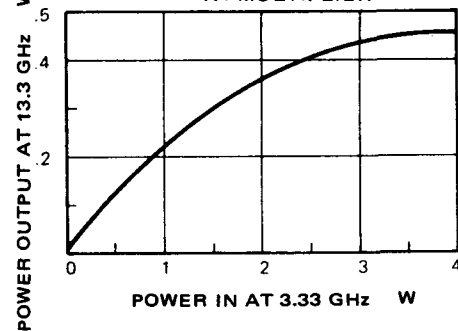

MA-43004
OUTPUT POWER vs. TEMPERATURE IN X4 MULTIPLIER

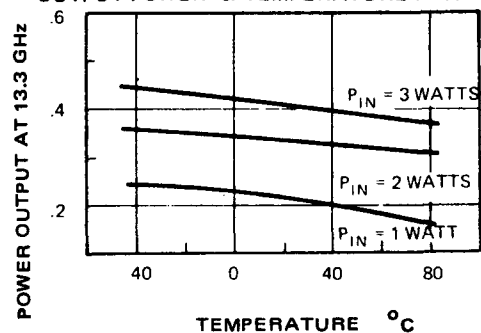

MEASURED WITH TEMPERATURE COMPENSATION CIRCUIT

MA-43004
PERCENT CHANGE IN LIFETIME vs. FORWARD CURRENT

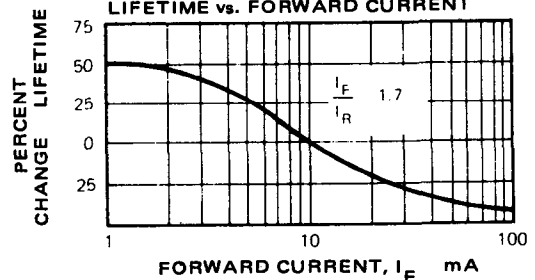

POWER GENERATION AND AMPLIFICATION

TYPICAL PERFORMANCE CURVES (Continued)

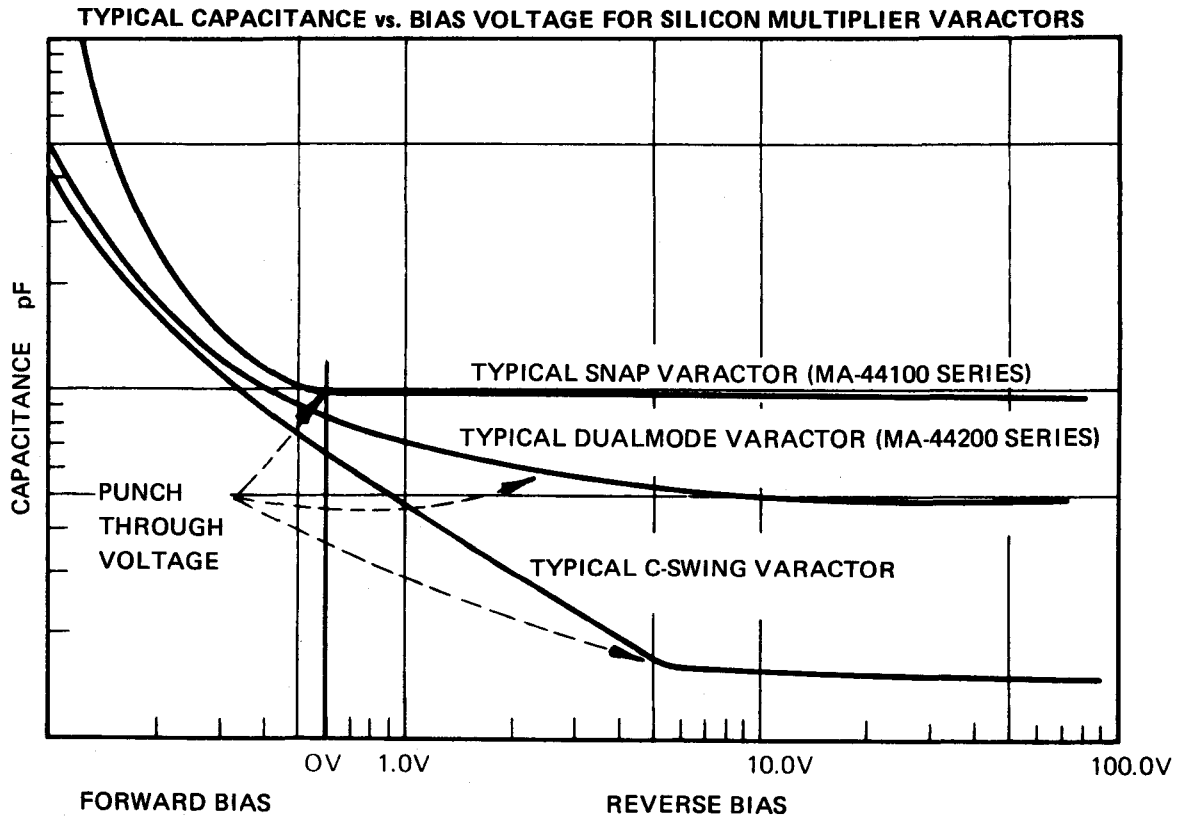
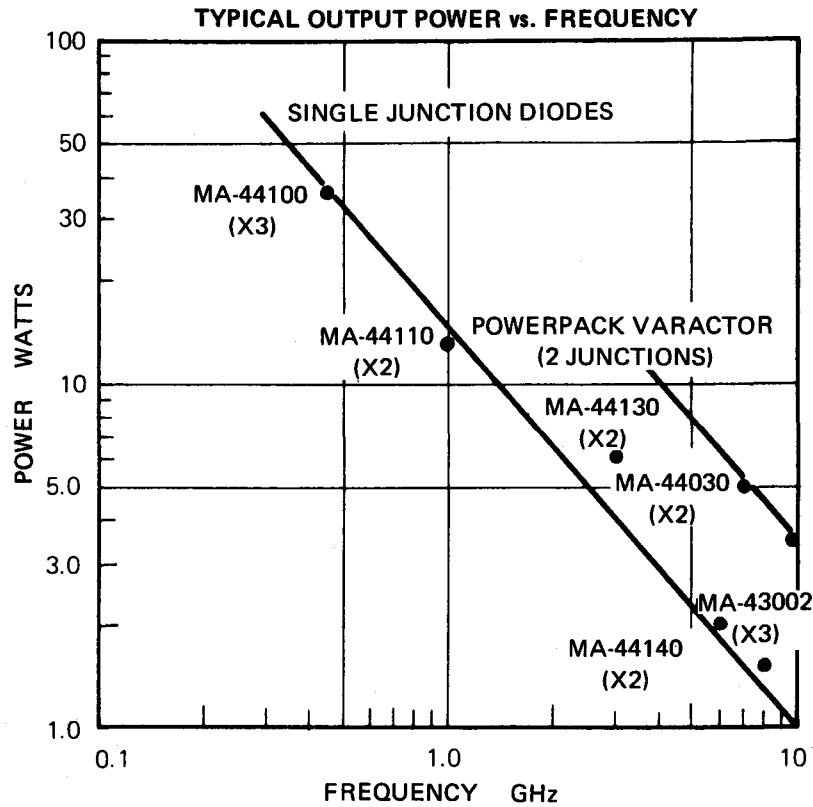

GaAs Multiplier Varactors

MA-48700 Series

DESCRIPTION

The MA-48700 series of Gallium Arsenide multiplier Varactors is specifically designed to provide single-stage, high order multiplication at output frequencies ranging from 3 to 80 GHz. These diodes are diffused junction epitaxial devices. All varactors in this series are available in a choice of 15 different case assemblies and in chip form. Available case assemblies are shown at the rear of this bulletin. The cathode is a heat sink end of the package.

APPLICATIONS

This series of Gallium Arsenide multiplier diodes are intended for medium power harmonic generation with high conversion efficiency.

ELECTRICAL CHARACTERISTICS @ $T_A = 25^\circ\text{C}$

F_{CO} GHz	C_{JO} (pF)				
	.150 - .199	.200 - .249	.250 - .299	.300 - .349	.350 - .399
100	MA-48701-A	MA-48702-A	MA-48703-A	MA-48704-A	MA-48705-A
125	MA-48701-B	MA-48702-B	MA-48703-B	MA-48704-B	MA-48705-B
150	MA-48701-C	MA-48702-C	MA-48703-C	MA-48704-C	MA-48705-C
175	MA-48701-D	MA-48702-D	MA-48703-D	MA-48704-D	MA-48705-D
200	MA-48701-E	MA-48702-E	MA-48703-E	MA-48704-E	MA-48705-E
225	MA-48701-F	MA-48702-F	MA-48703-F	MA-48704-F	MA-48705-F
250	MA-48701-G	MA-48702-G	MA-48703-G	MA-48704-G	MA-48705-G
275	MA-48701-H	MA-48702-H	MA-48703-H	MA-48704-H	MA-48705-H
300	MA-48701-I	MA-48702-I	MA-48703-I	MA-48704-I	MA-48705-I
325	MA-48701-J	MA-48702-J	MA-48703-J	MA-48704-J	
350	MA-48701-K	MA-48702-K	MA-48703-K		

F_{CO} GHz	C_{JO} (pF)					
	.400 - .449	.450 - .499	.500 - .549	.550 - .599	.600 - .649	.650 - .699
100	MA-48706-A	MA-48707-A	MA-48708-A	MA-48709-A	MA-48710-A	MA-48711-A
125	MA-48706-B	MA-48707-B	MA-48708-B	MA-48709-B	MA-48710-B	MA-48711-B
150	MA-48706-C	MA-48707-C	MA-48708-C	MA-48709-C	MA-48710-C	MA-48711-C
175	MA-48706-D	MA-48707-D	MA-48708-D	MA-48709-D	MA-48710-D	MA-48711-D
200	MA-48706-E	MA-48707-E	MA-48708-E	MA-48709-E	MA-48710-E	MA-48711-E
225	MA-48706-F	MA-48707-F				



MICROWAVE ASSOCIATES, INC. BURLINGTON, MASSACHUSETTS

POWER GENERATION
AND AMPLIFICATION

NOTES:

1. All GaAs multiplier diodes are available in any case style shown in this bulletin as well as in chip form. When ordering, specify the desired case by adding the case designation as a suffix to the type number. For example: on MA-48703-G-155 specifies a GaAs multiplier diode with a minimum cutoff frequency at 0 volts of 250 GHz and a C_{J0} of between .250 and .299. The device is packaged in the 155 case style.
2. Junction Capacitance (C_{J0}) is measured at 1 MHz and 0 volts, on a bridge which has been balanced with a shielded test holder connected in place — but open circuited.
3. Package parasitics (C_p and L_p) are given along with package outlines elsewhere in this bulletin. The C_p values listed are typically $\pm .02$ pF. However the actual package capacitance of each diode is measured to within $\pm .0025$ pF. Parasitic inductance has been determined at X-band using DeLoach measurements.
4. Cutoff frequency measurements (F_{C0}) are made at 0 volts using the DeLoach method. See curve of Figure 1 showing typical F_{C-6} (cutoff at -6 volts) versus F_{C0} (cutoff at 0 volts) performance curve.

5. The measured series resonant frequency of each varactor will be supplied with the Diode.

$$6. \Delta N_J = \frac{C_{J0} - C_{J-6}}{C_{J0}} = .52 \text{ Typical}$$

$$\beta = \frac{C_{J+.5}}{C_{J-3}} = 2.20 \text{ Typical}$$

7. All GaAs multiplier diodes are subjected to a 48 hour 100°C electrical burn-in before final tests. During this period, each device is stressed 60 times per second with 30 mA in the forward direction and 5 volts in the back direction.
8. Typical breakdown voltage is between 18 and 25 volts at $-10 \mu\text{A}$. Custom tailored breakdown voltages are available on request.
9. DeLoach holders for cutoff frequency measurements as well as shielded test fixtures for measuring capacitance are available for purchase.

TYPICAL PERFORMANCE CURVE

FIGURE 1 TYPICAL RELATIONSHIP BETWEEN CUTOFF FREQUENCY AT ZERO AND SIX VOLTS IN GaAs VARACTOR DIODE

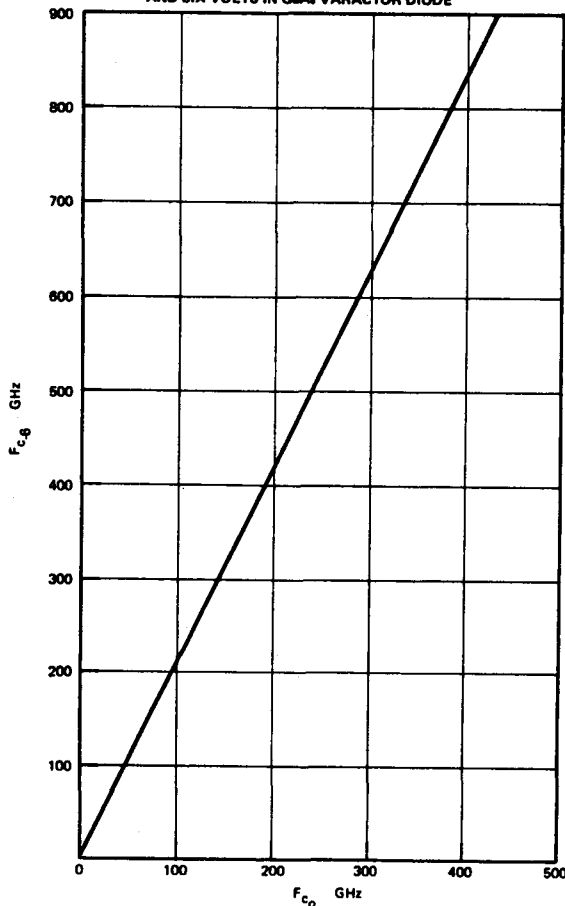
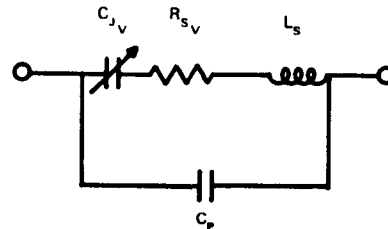

FIGURE 2 VARACTOR DIODE EQUIVALENT CIRCUIT



THE DELOACH METHOD FOR VARACTOR CHARACTERIZATION

Many methods exist for measuring the quality factor or cutoff frequency (F_c) of varactor diodes. Among the most widely used methods are the reflection coefficient techniques of Houlding [1] and Harrison [2]. Unfortunately, at high microwave frequencies, varactor "parasitics" such as supporting structures, contacting straps, and case capacitance tend to make reflection test set calibrations difficult. Also, as varactor quality factor increases, the accuracy of these techniques decreases.

In 1964, DeLoach [3] devised a method for varactor characterization that avoided the above difficulties. This method involved the series resonance of a varactor diode and yielded not only series resistance but junction capacitance and parasitic inductance at any bias voltage. All of these parameters were determined at the self-resonant frequency of the device and in a defined microwave environment. However, the case capacitance of DeLoach's packaged diodes was essentially non-existent thus simplifying certain mathematical solutions. Many widely used industrial varactor packages do have case capacitances that may in fact be larger than the device's junction capacitance.

It can be shown that the inclusion of case capacitance in the equivalent varactor circuit (shown in Figure 2) will modify the determination of cutoff frequency obtained by DeLoach's methods.

DeLoach's formula for diode resistance is as follows:

$$R_m = \left(\frac{Z_o}{2}\right) \left(\frac{1}{\sqrt{T-1}}\right) \quad (1)$$

Expansion of the expression for the real part of the total diode impedance, however, reveals that:

$$R_{s_v} = (X_{c_p})^2 - \frac{\sqrt{(X_{c_p})^4 - (4)(R_m)^2 (X_{L_s} + X_{c_p} + X_{c_j})^2}}{2(R_m)} \quad (2)$$

It follows that:

$$F_{c_v} = \frac{1}{2\pi R_{s_v} C_{j_v}} \quad (3)$$

where:

T = power transmission loss ratio

Z_o = characteristic guide impedance at resonance

R_m = Re [Z_v]

C_{j_v} = junction capacitance at Reverse bias voltage V

X_{c_j}, X_{c_p}, X_{L_s} = junction, package, and inductive reactances respectively

R_{s_v} = junction series resistance at voltage V

F_{c_v} = varactor figure of merit or cutoff frequency at voltage V

DeLoach's method not only results in additional information for the circuit designer, but is a more repeatable measurement that allows much greater accuracy in diode selection resulting in increased customer yields. DeLoach's measurements, however, are only as good as the diode holder used. Figure 3 shows a typical DeLoach holder in cross-sectioned view. This is but one of 36 different holders used by M/A to evaluate GaAs varactors over a total frequency range of 5 GHz to 40 GHz. Each holder is computer designed to cover a full waveguide band. The waveguide height in each case is reduced to the ceramic height of the diode package under test. The VSWR of each holder and choke combination is less than 1.1:1 across the waveguide band. Figure 4 is a block diagram of the DeLoach test circuit.

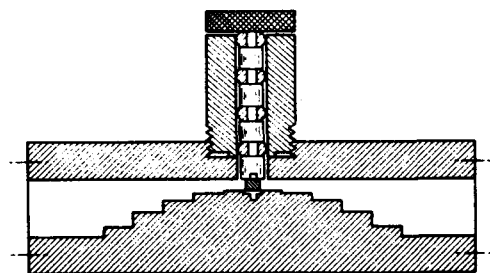

FIGURE 3 TYPICAL DELOACH HOLDER

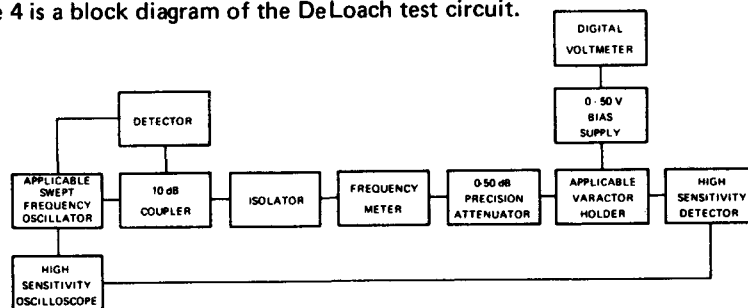
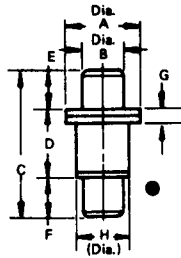

FIGURE 4 TYPICAL DELOACH TEST SET

- [1] Houlding, N., "Measurement of Varactor Quality", Microwave Journal, Volume 3, No. 1, January 1960.
- [2] Harrison, R., "Parametric Diode Q Measurements", Microwave Journal, Volume 3, No. 5, May 1960.
- [3] DeLoach, B.C., "A New Microwave Measurement Technique to Characterize Diodes and an 800 Gc Cutoff Frequency Varactor at Zero Volts Bias", IEEE Transactions on M.T. & T., January 1964.

CASE STYLES

30



TYPICAL
 $L_p = .60 \text{ nH}$
 $C_p = .18 \text{ pF}$

DIM.	INCHES		MM	
	MIN.	MAX.	MIN.	MAX.
A	.119	.127	3.02	3.23
B	.080	.064	1.52	1.63
C	.206	.225	5.21	5.72
D	.085	.097	2.16	2.46
E	.060	.064	1.52	1.63
F	.080	.064	1.52	1.63
G	.016	.024	0.41	0.61
H	.079	.083	2.01	2.11

31

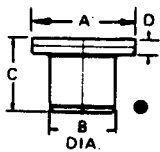

TYPICAL
 $L_p = .60 \text{ nH}$
 $C_p = .18 \text{ pF}$

DIM.	INCHES		MM	
	MIN.	MAX.	MIN.	MAX.
A	.119	.127	3.02	3.23
B	.077	.083	1.95	2.11
C	.085	.097	2.16	2.46
D	.016	.024	0.41	0.61

32

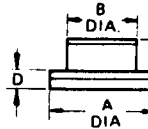

TYPICAL
 $L_p = .40 \text{ nH}$
 $C_p = .30 \text{ pF}$

DIM.	INCHES		MM	
	MIN.	MAX.	MIN.	MAX.
A	.119	.125	3.02	3.18
B	.077	.083	1.96	2.11
C	.055	.065	1.40	1.65
D	—	.025	—	0.64

36

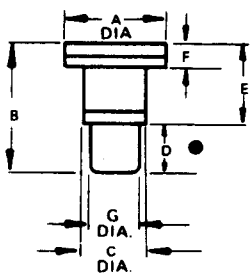

TYPICAL
 $L_p = .60 \text{ nH}$
 $C_p = .18 \text{ pF}$

DIM.	INCHES		MM	
	MIN.	REF. MAX.	MIN.	REF. MAX.
A	.119	— .125	3.02	— 3.18
B	.143	— .163	3.63	— 4.14
C	.077	— .083	1.96	— 2.11
D	.080	— .064	1.52	— 1.63
E	—	.091	—	2.31
F	—	— .025	—	— 0.64
G	.080	— .064	1.52	— 1.63

91

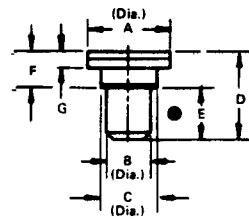

TYPICAL
 $L_p = .40 \text{ nH}$
 $C_p = .30 \text{ pF}$

DIM.	INCHES		MM	
	MIN.	MAX.	MIN.	MAX.
A	.119	.127	3.02	3.23
B	.060	.062	1.52	1.57
C	.077	.083	1.96	2.11
D	.115	.129	2.92	3.28
E	.080	.064	1.52	1.63
F	.055	.065	1.40	1.65
G	.016	.024	0.41	0.61

92

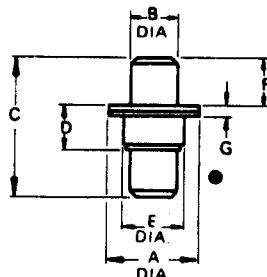

TYPICAL
 $L_p = .40 \text{ nH}$
 $C_p = .30 \text{ pF}$

DIM.	INCHES		MM	
	MIN.	MAX.	MIN.	MAX.
A	.119	.127	3.02	3.23
B	.081	.085	1.55	1.65
C	.174	.184	4.42	4.93
D	.055	.065	1.40	1.65
E	.077	.083	1.96	2.11
F	.060	.064	1.52	1.63
G	.016	.024	0.41	0.61

94

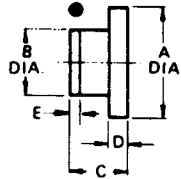

TYPICAL
 $L_p = .17 \text{ nH}$
 $C_p = .15 \text{ pF}$

DIM.	INCHES		MM	
	MIN.	MAX.	MIN.	MAX.
A	.078	.086	1.98	2.18
B	.047	.063	1.19	1.35
C	.040	.050	1.02	1.27
D	—	.015	—	0.381
E	.004	.010	0.102	0.254

95

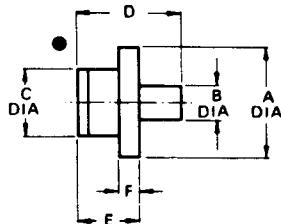

TYPICAL
 $L_p = .17 \text{ nH}$
 $C_p = .15 \text{ pF}$

DIM.	INCHES		MM	
	MIN.	MAX.	MIN.	MAX.
A	.078	.086	1.98	2.18
B	.024	.026	0.61	0.66
C	.047	.063	1.19	1.35
D	.070	.080	1.78	2.03
E	.040	.050	1.02	1.27
F	—	.015	—	0.38

126

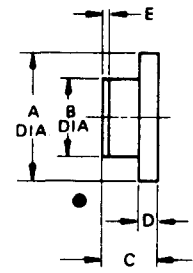

TYPICAL
 $L_p = .2 \text{ nH}$
 $C_p = .23 \text{ pF}$

DIM.	INCHES		MM	
	MIN.	MAX.	MIN.	MAX.
A	.079	.087	2.01	2.21
B	.047	.063	1.19	1.35
C	.030	.038	0.76	0.97
D	.009	.015	0.23	0.38
E	.003 REF.	—	0.076 REF.	—

128

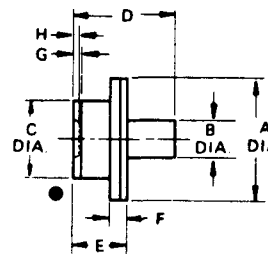

TYPICAL
 $L_p = .20 \text{ nH}$
 $C_p = .23 \text{ pF}$

DIM.	INCHES		MM	
	MIN.	MAX.	MIN.	MAX.
A	.077	.083	1.96	2.11
B	.022	.028	0.56	0.71
C	.047	.053	1.19	1.35
D	.0545	.0675	1.38	1.71
E	.0295	.0325	0.75	0.83
F	.010	.015	0.25	0.38
G	.002	.007	0.05	0.17
H	.0015	.0030	0.04	0.08

155

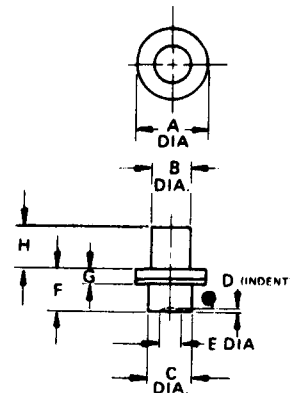

TYPICAL
 $L_p = .16 \text{ nH}$
 $C_p = .13 \text{ pF}$

DIM.	INCHES		MM	
	MIN.	MAX.	MIN.	MAX.
A	.043	.047	1.09	1.19
B	.024	.026	0.61	0.66
C	.029	.031	0.74	0.79
D	.001	.002	0.03	0.05
E	.016	.010	0.41	0.25
F	.022	.028	0.56	0.71
G	.007	.009	0.18	0.23
H	.026	.034	0.66	0.86

• Denotes Cathode End.

Not to scale.

156

TYPICAL
 $L_p = .40 \text{ nH}$
 $C_p = .24 \text{ pF}$

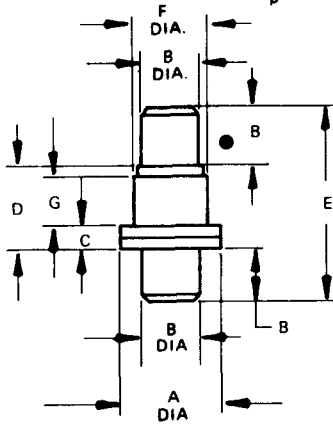

DIM.	INCHES		MM	
	MIN.	MAX.	MIN.	MAX.
A	.117	.123	2.97	3.12
B	.060	.064	1.52	1.63
C	.016	.024	0.40	0.61
D	.065	.065	1.40	1.65
E	.174	.194	4.42	4.93
F	.077	.083	1.96	2.11
G	.033 REF.		0.84 REF.	

159

TYPICAL
 $L_p = .60 \text{ nH}$
 $C_p = .15 \text{ pF}$

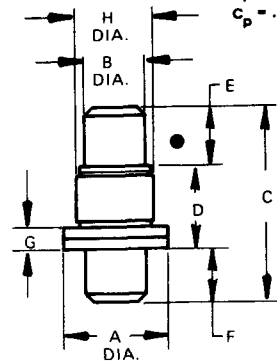

DIM.	INCHES		MM	
	MIN.	MAX.	MIN.	MAX.
A	.119	.127	3.02	3.23
B	.060	.064	1.52	1.63
C	.205	.225	5.21	5.72
D	.085	.097	2.16	2.46
E	.060	.064	1.52	1.63
F	.060	.064	1.52	1.63
G	.016	.024	0.41	0.61
H	.079	.083	2.01	2.11

157

TYPICAL
 $L_p = .40 \text{ nH}$
 $C_p = .24 \text{ pF}$

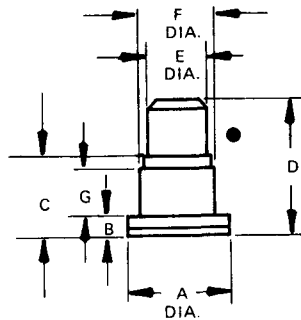

DIM.	INCHES		MM	
	MIN.	MAX.	MIN.	MAX.
A	.117	.123	2.97	3.12
B	.016	.024	0.41	0.61
C	.065	.065	1.40	1.65
D	.117	.127	2.97	3.23
E	.060	.064	1.52	1.63
F	.077	.083	1.96	2.11
G	.033 REF.		0.83 REF.	

168

TYPICAL
 $L_p = .20 \text{ nH}$
 $C_p = .23 \text{ pF}$

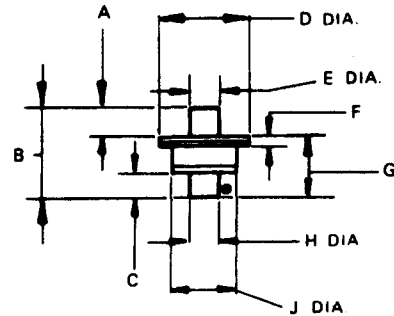

DIM.	INCHES		MM	
	MIN.	MAX.	MIN.	MAX.
A	.028	.032	0.71	0.81
B	.064	.066	2.13	2.44
C	.028	.032	0.71	0.81
D	.079	.081	2.01	2.06
E	.024	.026	0.61	0.66
F	.008	.010	0.20	0.25
G	.048	.054	1.22	1.37
H	.024	.026	0.61	0.66

● Denotes Cathode End.

Not to scale.

GaAs Parametric Amplifier Varactors

Bulletin 4850

POWER GENERATION
AND AMPLIFICATION

MA-48500 Series

FEATURES

- High cutoff frequency
- Operating temperatures from 4^oK to 352^oK
- Low noise temperature
- Large gain-bandwidth capability
- High pump efficiencies
- Custom tailored designs available on request

APPLICATIONS

This series of Gallium Arsenide paramp diodes is useful in either degenerate or non-degenerate parametric amplifiers. Low diode series resistances result in minimum amplifier noise temperatures while large capacitive nonlinearities provide maximum pump efficiencies.

DESCRIPTION

The MA-48500 series of diffused junction epitaxial Gallium Arsenide Varactors is specifically designed for use in both room temperature and cryogenically cooled parametric amplifiers. High gain-bandwidth products can be achieved using these diodes over the signal frequency range of 1 GHz to 35 GHz with pump frequencies as high as 90 GHz. All varactors in this series are available in a choice of 15 different case assemblies and in chip form as shown elsewhere in this bulletin. The cathode is the heat sink end of the package. Reverse polarity is available on request.

GaAs Parametric Amplifier Varactors

MA-48500 Series

ELECTRICAL CHARACTERISTICS @ $T_A = 25^\circ\text{C}$

F_{CO} (GHz)	C_{JO} (pF)				
	.150 - .199	.200 - .249	.250 - .299	.300 - .349	.350 - .399
100	MA-48501-A	MA-48502-A	MA-48503-A	MA-48504-A	MA-48505-A
125	MA-48501-B	MA-48502-B	MA-48503-B	MA-48504-B	MA-48505-B
150	MA-48501-C	MA-48502-C	MA-48503-C	MA-48504-C	MA-48505-C
175	MA-48501-D	MA-48502-D	MA-48503-D	MA-48504-D	MA-48505-D
200	MA-48501-E	MA-48502-E	MA-48503-E	MA-48504-E	MA-48505-E
225	MA-48501-F	MA-48502-F	MA-48503-F	MA-48504-F	MA-48505-F
250	MA-48501-G	MA-48502-G	MA-48503-G	MA-48504-G	MA-48505-G
275	MA-48501-H	MA-48502-H	MA-48503-H	MA-48504-H	
300	MA-48501-I	MA-48502-I	MA-48503-I		
325	MA-48501-J	MA-48502-J			
350	MA-48501-K	MA-48502-K			

F_{CO} (GHz)	C_{JO} (pF)					
	.400 - .449	.450 - .499	.500 - .549	.550 - .599	.600 - .649	.650 - .699
100	MA-48506-A	MA-48507-A	MA-48508-A	MA-48509-A	MA-48510-A	MA-48511-A
125	MA-48506-B	MA-48507-B	MA-48508-B	MA-48509-B	MA-48510-B	MA-48511-B
150	MA-48506-C	MA-48507-C	MA-48508-C	MA-48509-C	MA-48510-C	MA-48511-C
175	MA-48506-D	MA-48507-D	MA-48508-D	MA-48509-D	MA-48510-D	MA-48511-D
200	MA-48506-E	MA-48507-E	MA-48508-E	MA-48509-E	MA-48510-E	MA-48511-E
225	MA-48506-F	MA-48507-F				

NOTES: (Continued on following page.)

POWER GENERATION
AND AMPLIFICATION



MICROWAVE ASSOCIATES, INC. BURLINGTON, MASSACHUSETTS

NOTES:

1. All GaAs Paramp diodes are available in any case style shown in this bulletin as well as in chip form. When ordering, specify the desired case by adding the case designation as a suffix to the type number. For example: MA-48503-G-155 specifies a paramp diode with a minimum cutoff frequency at 0 volts of 250 GHz and a C_{J0} of between .250 and .299. The device is packaged in the ODS-155 case.
2. Junction Capacitance (C_{J0}) is measured at 1 MHz and 0 volts, on a bridge which has been balanced with a shielded test holder connected in place — but open circuited.
3. Package parasitics (C_p and L_p) are given along with package outlines elsewhere in this bulletin. The C_p values listed are typically $\pm .02$ pF. However, the actual package capacitance of each diode is measured to within $\pm .0025$ pF.
4. Cutoff frequency measurements (F_{C0}) are made at 0

volts using the DeLoach method. See curve of Figure 1 showing typical F_{C-6} (cutoff at -6 volts) versus F_{C0}

(cutoff at 0 volts) performance curve.

5. The measured series resonant frequency of each varactor will be supplied with the diode.
6.
$$\Delta N_J = \frac{C_{J0} - C_{J6}}{C_{J0}} = .52 \text{ typical} \quad \beta = \frac{C_{J+ .5}}{C_{J-3}} = 2.20 \text{ typical}$$
7. All paramp varactors are cycled to liquid nitrogen temperatures to assure cryogenic performance.
8. All GaAs Paramp diodes are subjected to a 48 hour 100°C electrical burn-in before final tests. During this period, each device is stressed 60 times per second with 30 mA in the forward direction and 5 volts in the back direction.
9. Minimum breakdown voltage is 10 volts at 10 μ A.
10. DeLoach holders, for cutoff frequency measurements, as well as shielded test fixtures, for measuring capacitance, are available for purchase.

TYPICAL PERFORMANCE CURVE

FIGURE 1 TYPICAL RELATIONSHIP BETWEEN CUTOFF FREQUENCY AT ZERO AND SIX VOLTS IN GaAs VARACTOR DIODE

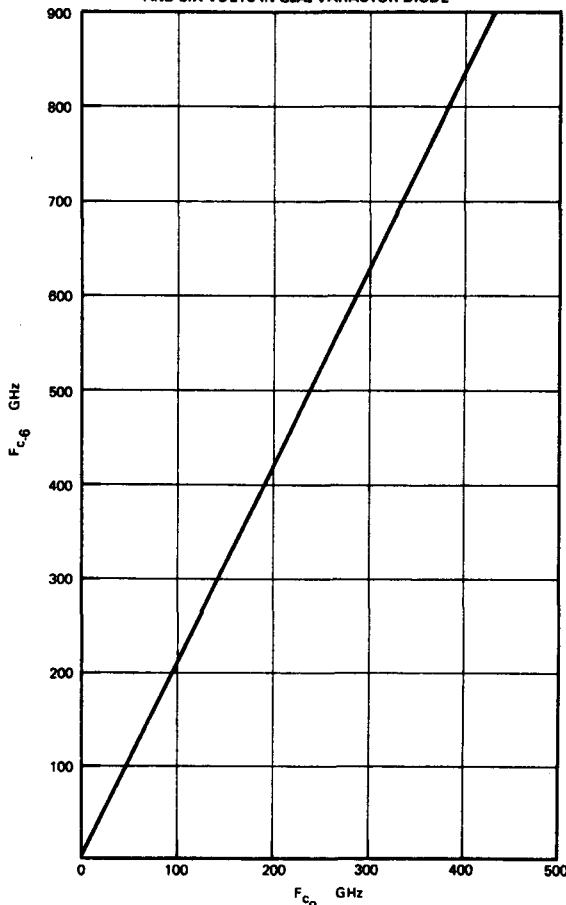
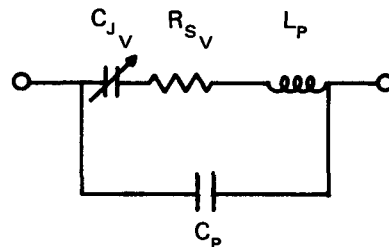

FIGURE 2 VARACTOR DIODE EQUIVALENT CIRCUIT



THE DELOACH METHOD FOR VARACTOR CHARACTERIZATION

Many methods exist for measuring the quality factor or cutoff frequency (F_c) of varactor diodes. Among the most widely used methods are the reflection coefficient techniques of Houlding [1] and Harrison [2]. Unfortunately, at high microwave frequencies, varactor "parasitics" such as supporting structures, contacting straps, and case capacitance tend to make reflection test set calibrations difficult. Also, as varactor quality factor increases, the accuracy of these techniques decreases.

In 1964, DeLoach [3] devised a method for varactor characterization that avoided the above difficulties. This method involved the series resonance of a varactor diode and yielded not only series resistance but junction capacitance and parasitic inductance at any bias voltage. All of these parameters were determined at the self-resonant frequency of the device and in a defined microwave environment. However, the case capacitance of DeLoach's packaged diodes was

essentially non-existent thus simplifying certain mathematical solutions. Many widely used industrial varactor packages have case capacitances that may in fact be larger than the device's junction capacitance.

It can be shown that the inclusion of case capacitance in the equivalent varactor circuit (shown in Figure 2) will modify the determination of cutoff frequency obtained by DeLoach's methods.

DeLoach's formula for diode resistance is as follows:

$$R_m = \left(\frac{Z_o}{2} \right) \left(\frac{1}{\sqrt{T-1}} \right) \quad (1)$$

Expansion of the expression for the real part of the total diode impedance, however, reveals that:

$$R_{s_v} = (X_{c_p})^2 - \frac{\sqrt{(X_{c_p})^4 - (4)(R_m)^2 (X_{L_s} + X_{c_p} + X_{c_j})^2}}{2(R_m)} \quad (2)$$

It follows that:

$$F_{c_v} = \frac{1}{2\pi R_{s_v} C_{j_v}} \quad (3)$$

where:

T = power transmission loss ratio

Z_o = characteristic guide impedance at resonance

R_m = $\text{Re} [Z_v]$

C_{j_v} = junction capacitance at Reverse bias voltage V

$X_{c_j}, X_{c_p}, X_{L_s}$ = junction, package, and inductive reactances respectively

R_{s_v} = junction series resistance at voltage V

F_{c_v} = varactor figure of merit or cutoff frequency at voltage V

[1] Houlding, N., "Measurement of Varactor Quality", *Microwave Journal*, Volume 3, No. 1, January 1960.

[2] Harrison, R., "Parametric Diode Q Measurements", *Microwave Journal*, Volume 3, No. 5, May 1960.

[3] DeLoach, B.C., "A New Microwave Measurement Technique to Characterize Diodes and an 800 Gc Cutoff Frequency Varactor at Zero Volts Bias", *IEEE Transactions on M.T. & T.*, January 1964.

THE DELOACH METHOD FOR VARACTOR CHARACTERIZATION (Continued)

DeLoach's method not only results in additional information for the circuit designer, but is a more repeatable measurement that allows much greater accuracy in diode selection resulting in increased customer yields. DeLoach's measurements, however, are only as good as the diode holder used. Figure 3 shows a typical DeLoach holder in cross-sectioned view. This is but one of 36 different holders used by M/A to evaluate GaAs varactors over a total frequency range of 5 GHz to 40 GHz. Each holder is computer designed to cover a full waveguide band. The waveguide height in each case is reduced to the ceramic height of the diode package under test. The VSWR of each holder and choke combination is less than 1.1:1 across the waveguide band. Figure 4 is a block diagram of the DeLoach test circuit.

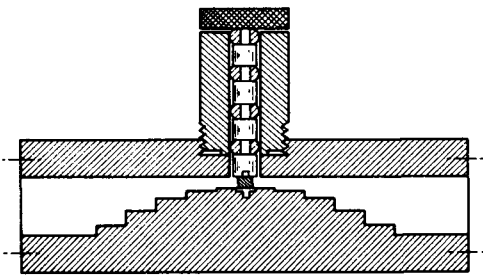

FIGURE 3 TYPICAL DELOACH HOLDER

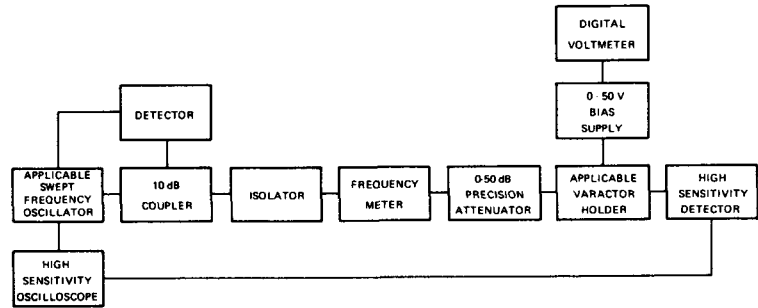
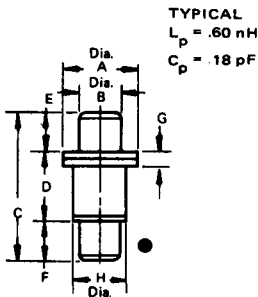

FIGURE 4 TYPICAL DELOACH TEST SET

CASE STYLES

30



DIM.	INCHES		MM	
	MIN.	MAX.	MIN.	MAX.
A	.119	.127	3.02	3.23
B	.060	.064	1.52	1.63
C	.205	.225	5.21	5.72
D	.085	.097	2.16	2.46
E	.060	.064	1.52	1.63
F	.060	.064	1.52	1.63
G	.016	.024	0.41	0.61
H	.079	.083	2.01	2.11

31

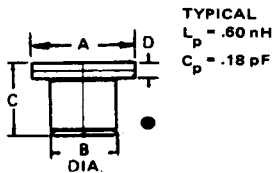

DIM.	INCHES		MM	
	MIN.	MAX.	MIN.	MAX.
A	.119	.127	3.02	3.23
B	.077	.083	1.95	2.11
C	.085	.097	2.16	2.46
D	.016	.024	0.41	0.61

32

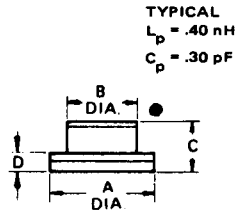

DIM.	INCHES		MM	
	MIN.	MAX.	MIN.	MAX.
A	.119	.125	3.02	3.18
B	.077	.083	1.96	2.11
C	.055	.065	1.40	1.65
D	—	.025	—	0.64

36

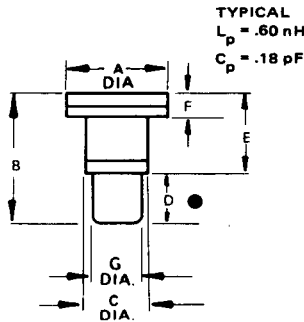

DIM.	INCHES				MM			
	MIN.	REF.	MAX.		MIN.	REF.	MAX.	
A	.119	—	.125		3.02	—	3.18	
B	.143	—	.163		3.63	—	4.14	
C	.077	—	.083		1.96	—	2.11	
D	.060	—	.064		1.52	—	1.63	
E	—	.091	—		—	2.31	—	
F	—	—	.025		—	—	0.64	
G	.080	—	.064		1.52	—	1.63	

91

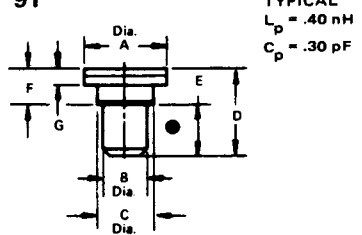

DIM.	INCHES		MM	
	MIN.	MAX.	MIN.	MAX.
A	.119	.127	3.02	3.23
B	.060	.062	1.52	1.57
C	.077	.083	1.96	2.11
D	.115	.129	2.92	3.28
E	.060	.064	1.52	1.63
F	.055	.065	1.40	1.65
G	.016	.024	0.41	0.61

92

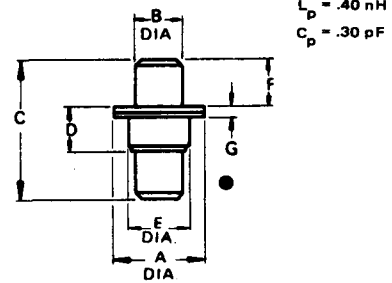

DIM.	INCHES		MM	
	MIN.	MAX.	MIN.	MAX.
A	.119	.127	3.02	3.23
B	.061	.065	1.55	1.65
C	.174	.194	4.42	4.93
D	.055	.065	1.40	1.65
E	.077	.083	1.96	2.11
F	.060	.064	1.52	1.63
G	.016	.024	0.41	0.61

● Denotes Cathode End.

Not to scale.

94

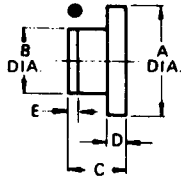

TYPICAL
 $L_p = .17 \text{ nH}$
 $C_p = .15 \text{ pF}$

DIM.	INCHES		MM	
	MIN.	MAX.	MIN.	MAX.
A	.078	.086	1.98	2.18
B	.047	.053	1.19	1.35
C	.040	.050	1.02	1.27
D	—	.015	—	0.381
E	.004	.010	0.102	0.254

95

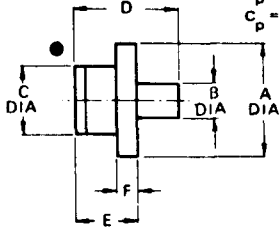

TYPICAL
 $L_p = .17 \text{ nH}$
 $C_p = .15 \text{ pF}$

DIM.	INCHES		MM	
	MIN.	MAX.	MIN.	MAX.
A	.078	.086	1.98	2.18
B	.024	.026	0.61	0.66
C	.047	.053	1.19	1.35
D	.070	.080	1.78	2.03
E	.040	.050	1.02	1.27
F	—	.015	—	0.38

126

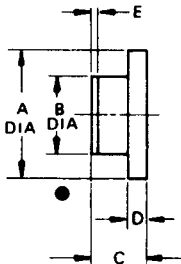

TYPICAL
 $L_p = .20 \text{ nH}$
 $C_p = .23 \text{ pF}$

DIM.	INCHES		MM	
	MIN.	MAX.	MIN.	MAX.
A	.079	.087	2.01	2.21
B	.047	.053	1.19	1.35
C	.030	.038	0.76	0.97
D	.009	.015	0.23	0.38
E	.003 REF.	—	0.076 REF.	—

128

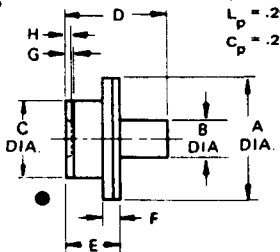

TYPICAL
 $L_p = .20 \text{ nH}$
 $C_p = .23 \text{ pF}$

DIM.	INCHES		MM	
	MIN.	MAX.	MIN.	MAX.
A	.077	.083	1.96	2.11
B	.022	.026	0.56	0.71
C	.047	.053	1.19	1.35
D	.0645	.0675	1.38	1.71
E	.0295	.0325	0.75	0.83
F	.010	.015	0.25	0.38
G	.002	.007	0.05	0.17
H	.0015	.0030	0.04	0.08

● Denotes Cathode End.

155

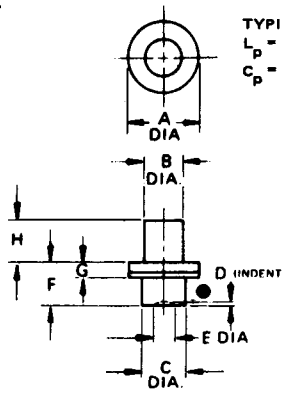

TYPICAL
 $L_p = .16 \text{ nH}$
 $C_p = .13 \text{ pF}$

DIM.	INCHES		MM	
	MIN.	MAX.	MIN.	MAX.
A	.043	.047	1.09	1.19
B	.024	.026	0.61	0.66
C	.029	.031	0.74	0.79
D	.001	.002	0.03	0.05
E	.016	.010	0.41	0.25
F	.022	.028	0.56	0.71
G	.007	.009	0.18	0.23
H	.026	.034	0.66	0.86

156

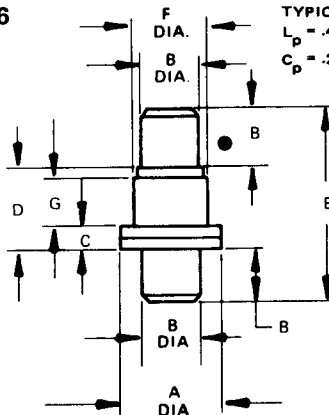

TYPICAL
 $L_p = .40 \text{ nH}$
 $C_p = .24 \text{ pF}$

DIM.	INCHES		MM	
	MIN.	MAX.	MIN.	MAX.
A	.117	.123	2.97	3.12
B	.060	.064	1.52	1.63
C	0.16	.024	0.40	0.61
D	.055	.065	1.40	1.65
E	.174	.194	4.42	4.93
F	.077	.083	1.96	2.11
G	.033 REF.	—	0.84 REF.	—

157

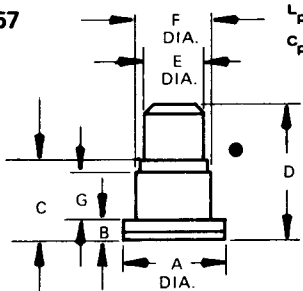

TYPICAL
 $L_p = .40 \text{ nH}$
 $C_p = .24 \text{ pF}$

DIM.	INCHES		MM	
	MIN.	MAX.	MIN.	MAX.
A	.117	.123	2.97	3.12
B	.016	.024	0.41	0.61
C	.055	.065	1.40	1.65
D	.117	.127	2.97	3.23
E	.060	.064	1.52	1.63
F	.077	.083	1.96	2.11
G	.033 REF.	—	0.83 REF.	—

159

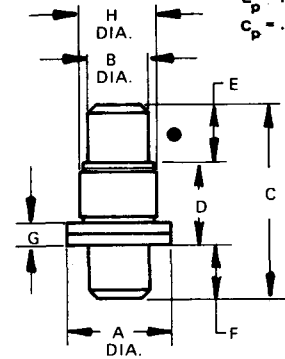

TYPICAL
 $L_p = .60 \text{ nH}$
 $C_p = .15 \text{ pF}$

DIM.	INCHES		MM	
	MIN.	MAX.	MIN.	MAX.
A	.119	.127	3.02	3.23
B	.060	.064	1.52	1.63
C	.205	.225	5.21	5.72
D	.085	.097	2.16	2.46
E	.060	.064	1.52	1.63
F	.060	.064	1.52	1.63
G	.016	.024	0.41	0.61
H	.079	.083	2.01	2.11

168

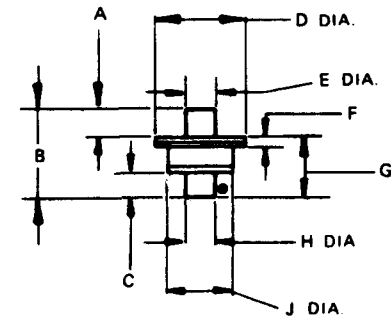

TYPICAL
 $L_p = .20 \text{ nH}$
 $C_p = .23 \text{ pF}$

DIM.	INCHES		MM	
	MIN.	MAX.	MIN.	MAX.
A	.028	.032	0.71	0.81
B	.084	.096	2.13	2.44
C	.028	.032	0.71	0.81
D	.079	.081	2.01	2.06
E	.024	.026	0.61	0.66
F	.008	.010	0.20	0.25
G	.048	.054	1.22	1.37
H	.024	.026	0.61	0.66

Not to scale.

All specifications are subject to change without notice.

MA-42020/ K2000 Series

***npn SILICON PLANAR TRANSISTORS
for UHF and MICROWAVE APPLICATIONS***

Bulletin 5201

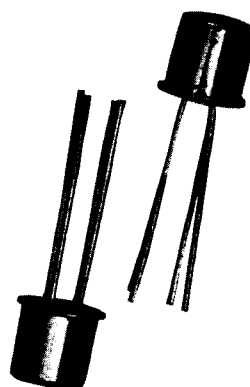

POWER GENERATION
AND AMPLIFICATION

FEATURES

- Low Cost
- Gold Metallization
- Low Noise
- High Gain

TYPICAL APPLICATIONS

IF, VHF, UHF, TV and RF Amplifiers

DESCRIPTION

This series of npn silicon planar transistors are designed especially for low cost applications demanding low noise, high gain performance. The transistors are rugged, highly reliable devices which utilize gold metallization.

2000 SERIES TRANSISTOR SPECIFICATIONS

Model Number	KMC Model Number	Max. Noise Figure @ I _c dB	Test Current I _c mA	Min. Gain @ I _c dB	1 dB Comp. Pt. @ I _c dBm	Ft. Typ. MHz	Test Frequency MHz
MA-42020-509	K2116	1.6	1.0	25	-10	2500	60
MA-42020-509	K2069	1.6	1.5	23	-10	2200	60
MA-42021-509	K2117	2.0	1.0	25	-10	2500	60
MA-42021-509	K2071	2.5	1.5	23	-10	2100	60
MA-42022-509	K2118	2.5	1.0	25	-10	2300	60
MA-42023-509	K2070	2.0	1.5	23	-10	2300	60
MA-42024-509	K2072	3.0	1.5	23	-10	2000	60
MA-42025-509	K2112	2.5	1.0	13	-10	2500	450
—	2N5031	2.5	1.0	10	-10	2100	450
—	2N3570	2.5	1.5	10	-10	2300	450
—	2N3953	3.0	1.0	10	-10	2000	450
MA-42026-509	K2113	3.0	1.0	13	-10	2300	450
—	2N5032	3.0	1.0	10	-10	2000	450
MA-42027-509	K2114	3.5	1.0	13	-10	2000	450
—	2N3880	3.5	1.5	10	-10	1800	450
—	2N3839	3.9	1.5	10	-10	1200	450
—	2N3571	4.0	2.0	10	-8	1200	450
MA-42028-509	K2073	4.0	1.5	10	-10	2000	450
MA-42029-509	K2115	4.0	1.0	13	-10	1800	450
—	2N5054	4.0	2.0	10	-8	1200	450
—	2N2857	4.5	1.5	10	-10	1000	450
—	2N3683	4.5	1.5	10	-10	1200	450
—	2N5179	4.5	2.0	10	-10	1300	450
—	2N5053	5.0	2.0	10	-10	1000	450
—	2N3572	1.0	2.0	10	-8	1000	450

ELECTRICAL PARAMETERS & MAXIMUM RATINGS (case temperature 25°C)

Symbol	Definition	Condition	Value
BV _{cbo}	Collector-base breakdown	I _c = 1 μA	30 V min.
BV _{ebo}	Emitter-base breakdown	I _e = 10 μA	2.5 V min.
I _{cbo}	Collector cut-off current	V _{cb} = 15 V	10 nA max.
h _{FE}	Current transfer ratio	V _{ce} = 1 V I _c = 3 mA	30 min. 300 max.
I _C	Collector current		50 mA max.
C _{cb}	Output capacitance	V _{cb} = 10 V	1.0 pF max.

CASE STYLE

509
(K)
TO-72

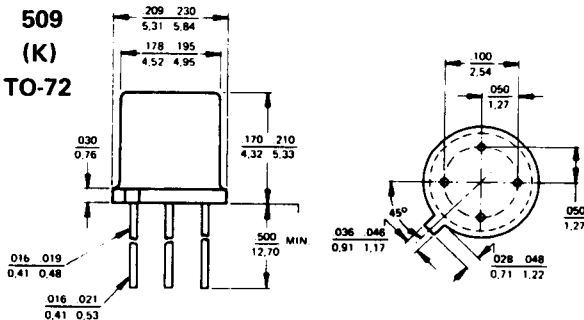

MA-42020 SERIES GEOMETRY

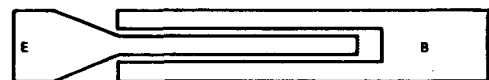

NOTE:

INCH
MM

TYPICAL PERFORMANCE CURVES

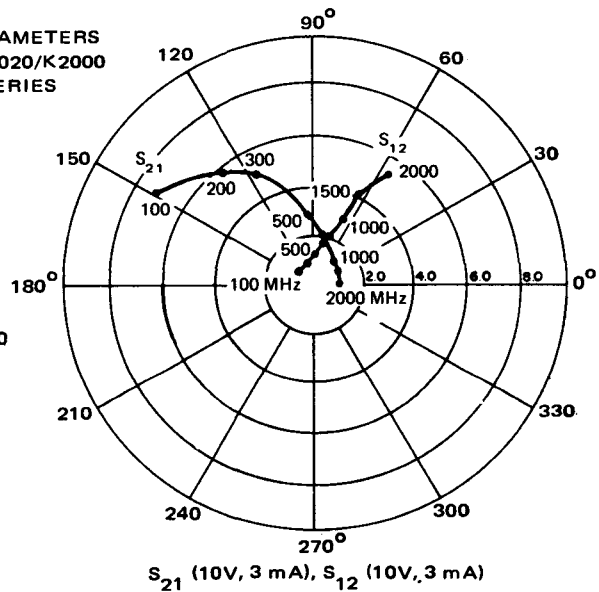
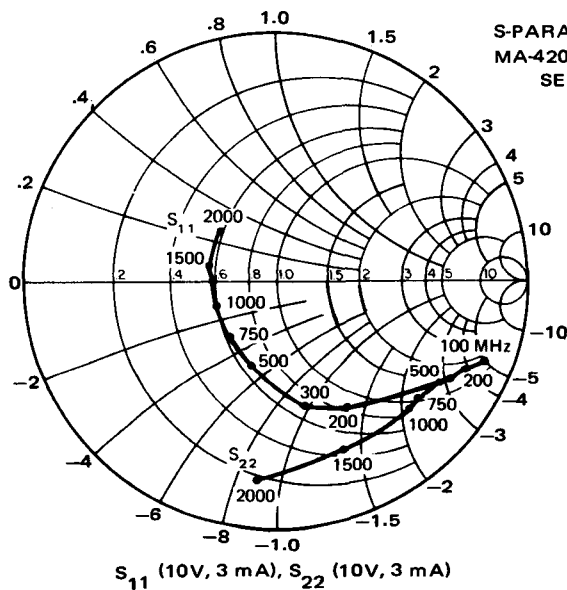
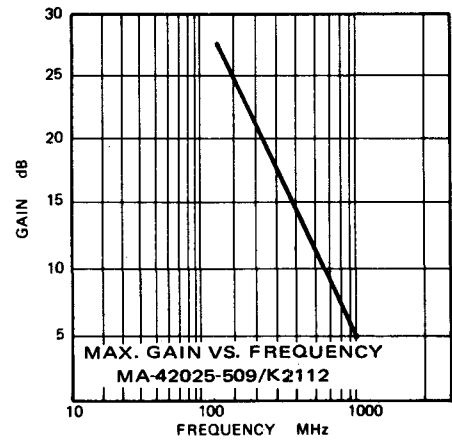
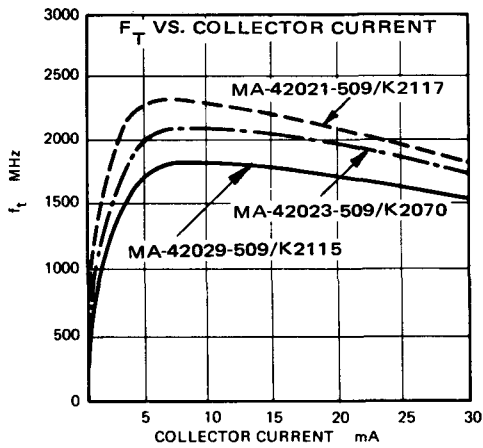
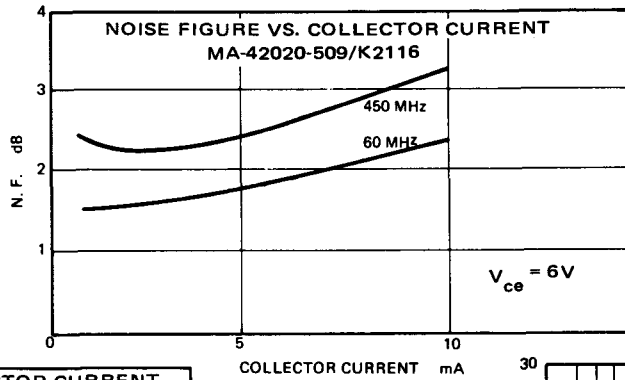
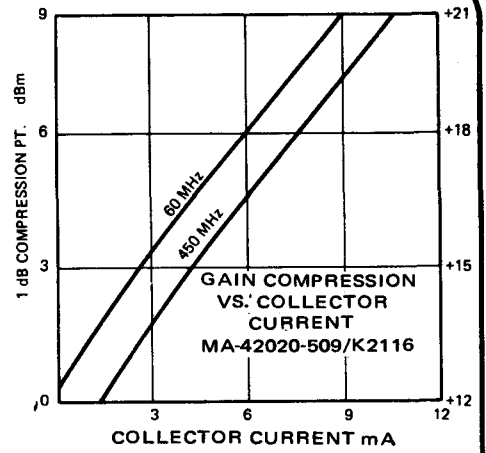
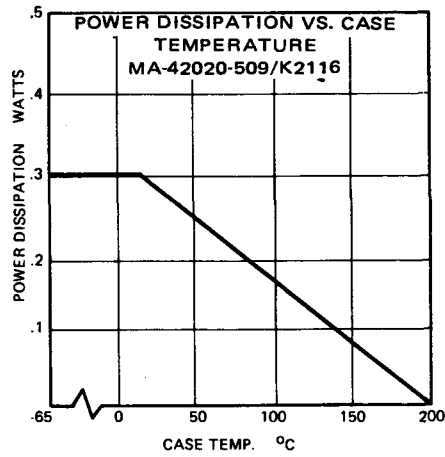
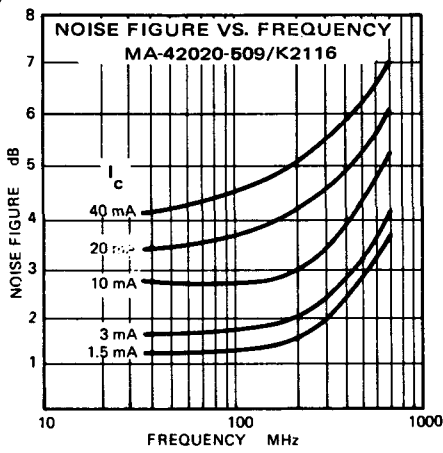

60 MHz TEST AMPLIFIER

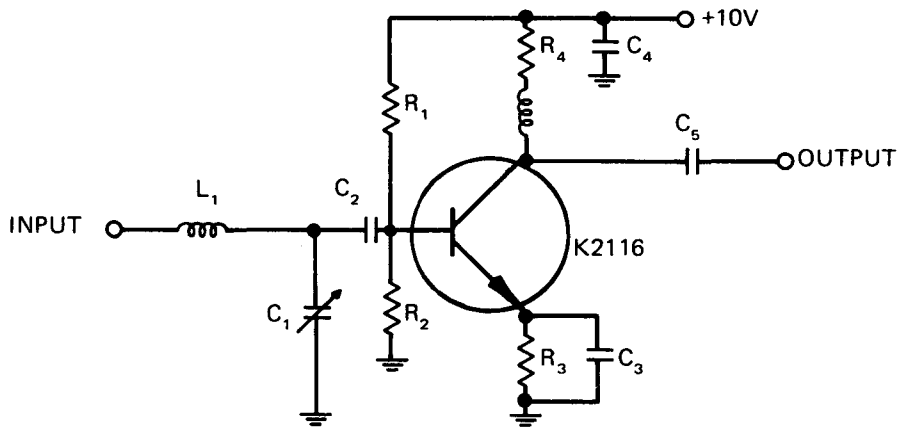

Parts List

$L_1 = .33 \mu\text{H}$	$R_1 = 5.3 \text{ K}\Omega$	$C_1 = 8-25 \text{ pF}$
$L_2 = .1 \mu\text{H}$	$R_2 = 700 \Omega$	$C_{2,3,4} = 1000 \text{ pF}$
	$R_3 = 20 \Omega$	
	$R_4 = 57 \Omega$	

450 MHz TEST AMPLIFIER

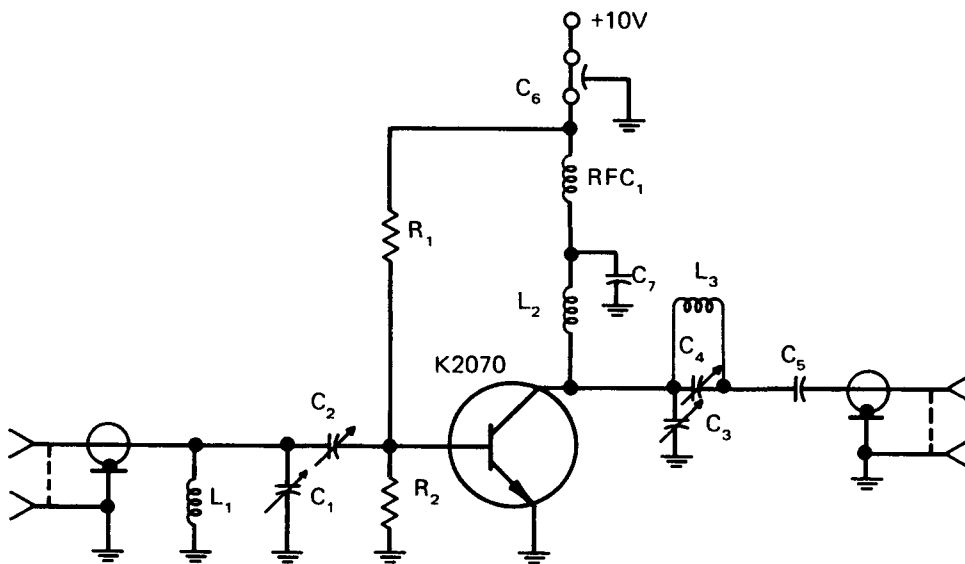

Parts List

L_1	Cu Strip 3/16" W x 1" L	C_1	C_3	1 - 10 pF
L_2	Cu Strip 3/16" W x 1-1/4" L	C_2		7 - 25 pF
L_3	1/2 turn 1/2" diameter No. 22 wire	C_4		2 - 8 pF
R_1^*	100K 1/4 W	C_5		470 pF leadless
R_2^*	10 K 1/4 W	C_6		1000 pF feedthru
RFC_1	Resonant at 450 MHz	C_7		500 pF mica-button

* Values must be adjusted for proper operating current.

MA-42050/K5500 Series

***npn Silicon Planar Transistors
for UHF and Microwave Applications***

Bulletin 5202

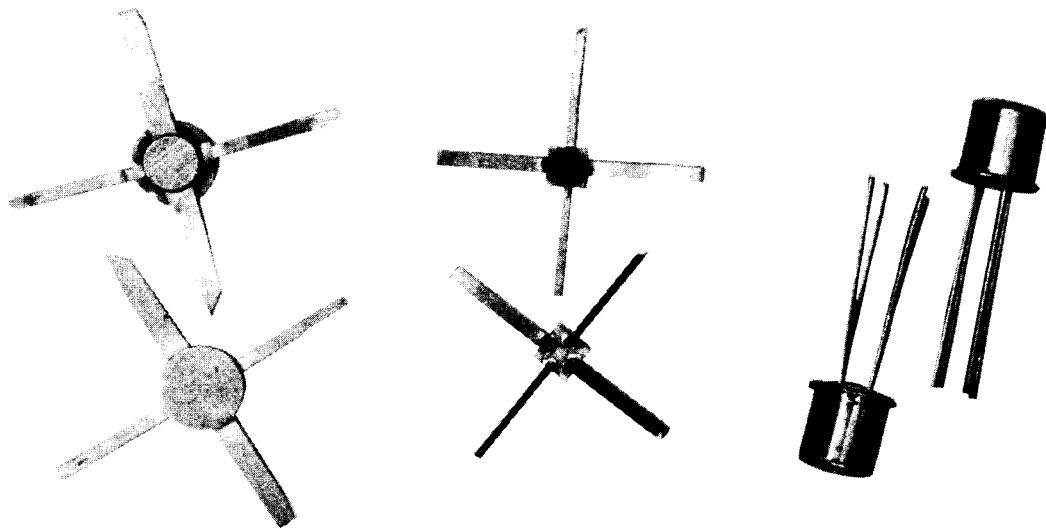

FEATURES

- High Gain
- Gold Metallization
- Low Noise
- Low Cost

APPLICATIONS

IF, VHF, UHF, TV and RF amplifiers and oscillators.

DESCRIPTION

This series of npn silicon planar transistors is highly reliable, rugged devices utilizing gold metallization. The design features high gain and low noise figure in amplifier applications and for low moderate power oscillators.

5500 SERIES TRANSISTOR SPECIFICATIONS

Low Noise Amplifier Transistors

Model Number	Case Style	KMC Model Number	Test Frequency MHz	Max. Noise Figure @ I _c dB	Min. Gain @ I _c dB	Test Current I _c mA	1 dB Compression Point Min. dBm	N.F. Ft. MHz
MA-42050	509, 510, 511	K5510	450	1.7	13	1.5	-10	2500
MA-42051	509, 510, 511	K5511	450	2.0	15	3.0	-8	2800
MA-42052	509, 510, 511	K5512	450	2.5	15	3.0	-8	2800
MA-42055	510, 511	KD5525	1000	3.0	10	3.0	-9	2800
MA-42056	510, 511	KD5526	1000	4.5	10	3.0	-7	2300
MA-42057	510, 511	KD5527	1000	3.7	10	3.0	-9	2500

JEDEC PART NO.

509	2N5651	450	2.0	13	3.0	-5	2500
509	2N5652	450	2.5	13	3.0	-5	2200

Oscillator Transistors (Common Base)

Model Number	Case Style	KMC Model Number	Test Frequency MHz	Power Output mW	Power Dissipation mW
MA-42060	510	KD5520	2400	150	450
MA-42061	510	KD5521	2500	100	450
MA-42062	510	KD5522	2500	80	450
MA-42063	510	KD5523	2500	50	450

ELECTRICAL PARAMETERS & RATINGS (case temperature 25°C)

Symbol	Definition	Condition	Value
BV_{cbo}	Collector-base breakdown	$I_c = 10 \mu A$	20 V Min.
BV_{ebo}	Emitter-base breakdown	$I_e = 10 \mu A$	2.5 V Min.
I_{cbo}	Collector cut-off current	$V_{cb} = 10 V$	50 nA Max.
h_{FE}	Current transfer ratio	$V_{ce} = 1 V$ $I_c = 3 mA$	20 Min.
I_c	Collector current		40 mA Max.
C_{ob}	Output capacitance	$V_c = 10 V$	0.75 pF Max.

CASE STYLES

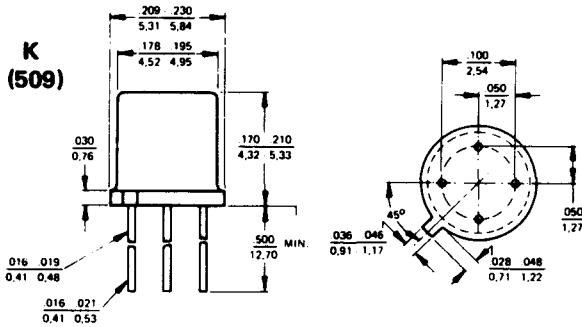

MA-42000 SERIES GEOMETRY



510

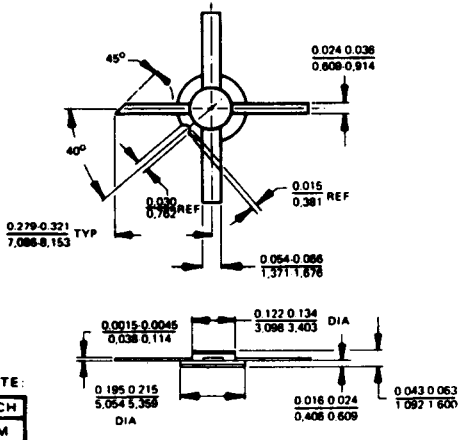

NOTE:
INCH
MM

KJ (511)

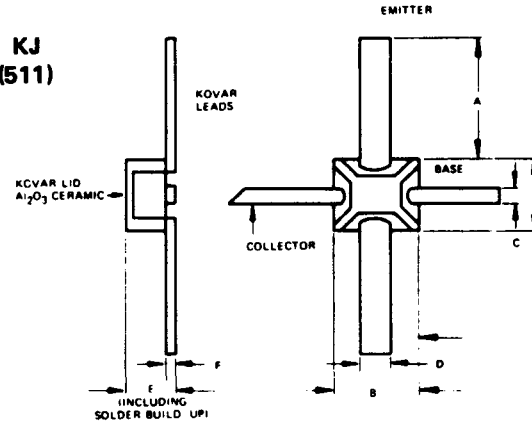

Leads 1-3 Available Common Base

A	B	C	D	E	F
0.230-0.280	0.095-0.105	0.016-0.074	0.036-0.044	0.002-0.006	0.050
5,841-7,112	2,413-2,667	0,406-0,609	0,914-1,117	0,060-0,162	1,270 MAX.

TYPICAL AMPLIFIER PERFORMANCE CURVES

450 MHz AMPLIFIER

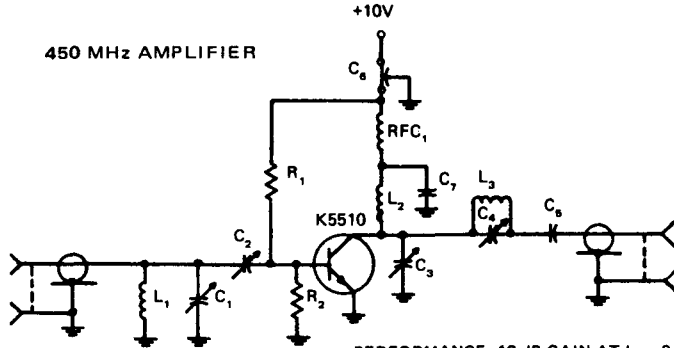

- L_1 Cu Strip 3/16" W x 1" L
 - L_2 Cu Strip 3/16" W x 1-1/4" L
 - L_3 1/2 turn 1/2" diameter No. 22 wire
 - R_1 * 100K 1/4 W
 - R_2 * 10K 1/4 W
 - RFC_1 Resonant at 450 MHz
 - C_1, C_3 1-10 pF
 - C_2 7-25 pF
 - C_4 2-8 pF
 - C_5 470 pF leadless
 - C_6 1000 pF feedthru
 - C_7 500 pF mica-button
- * Values must be adjusted for proper operating current.

PERFORMANCE: 12 dB GAIN AT $I_c = 6$ mA

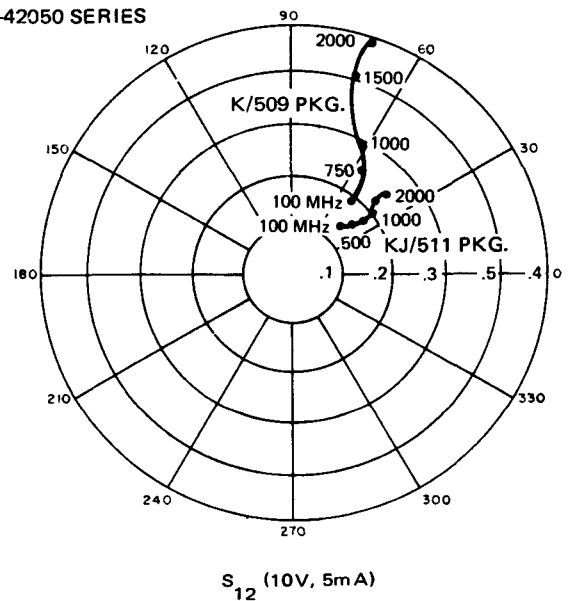
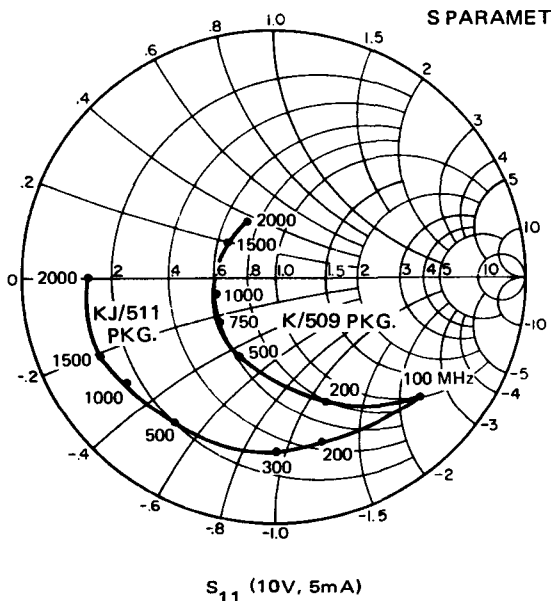
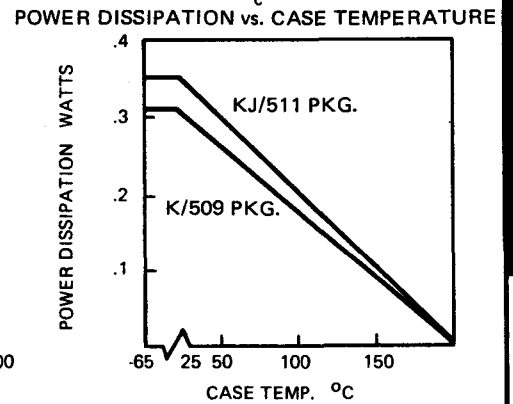
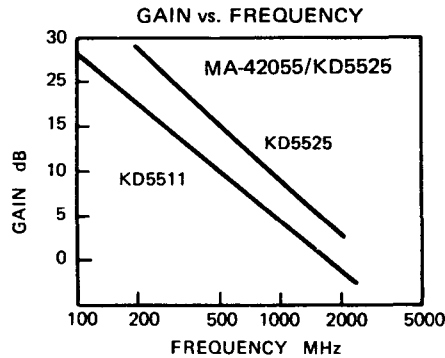
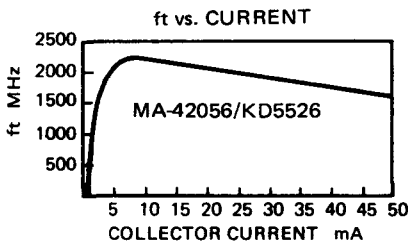
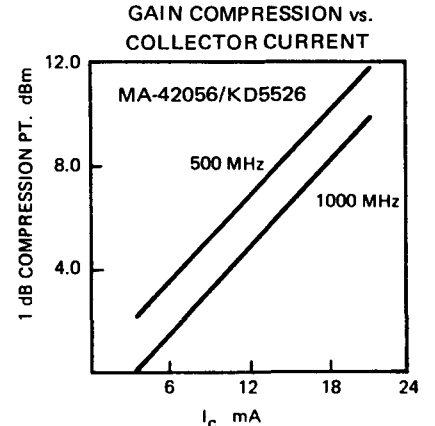
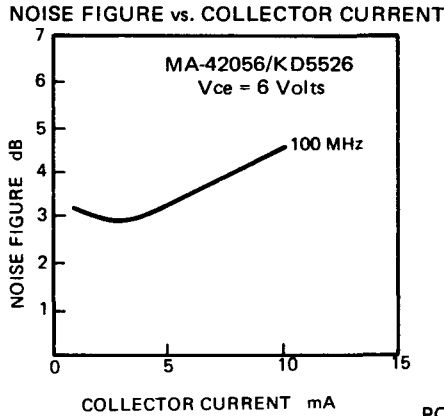
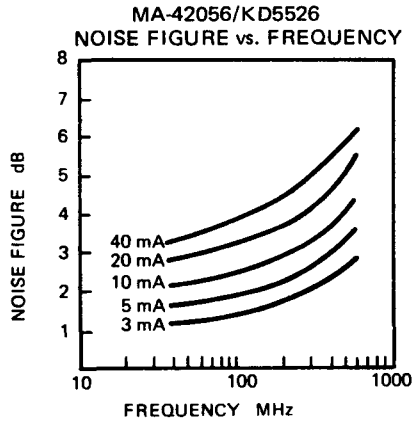

POWER GENERATION AND AMPLIFICATION

S PARAMETERS - MA-42050 SERIES - Continued

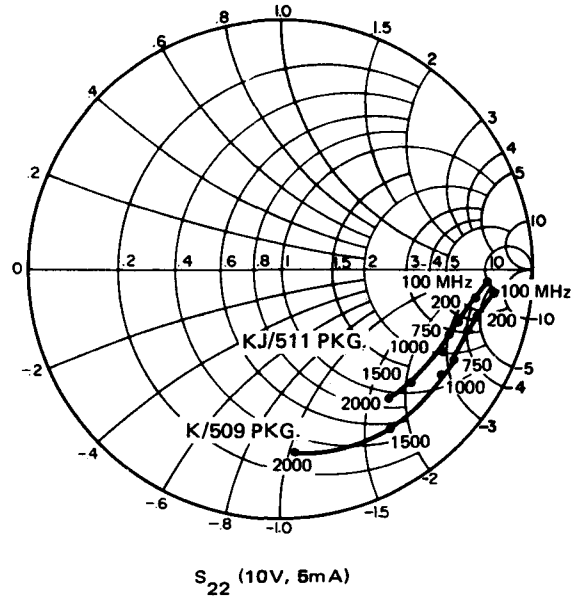
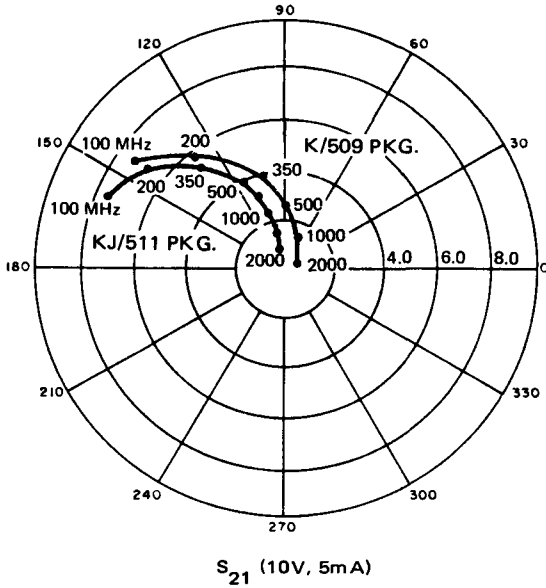

TYPICAL OSCILLATOR PERFORMANCE CURVES

OUTPUT POWER vs. COLLECTOR CURRENT

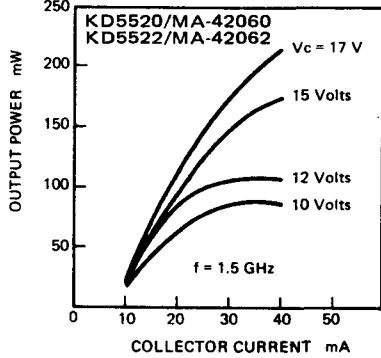

OUTPUT POWER vs. FREQUENCY

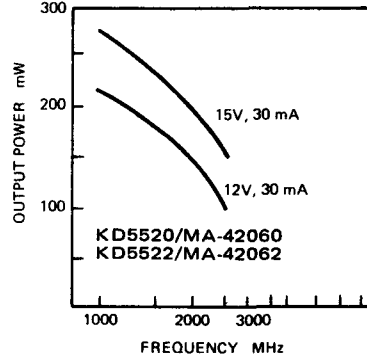

OUTPUT POWER vs. COLLECTOR CURRENT

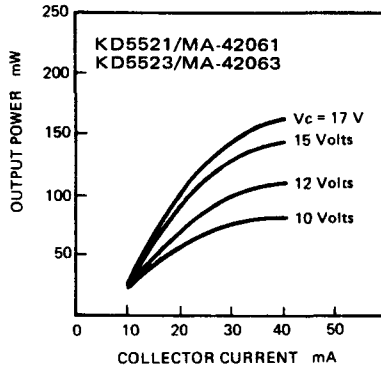

OUTPUT POWER vs. FREQUENCY

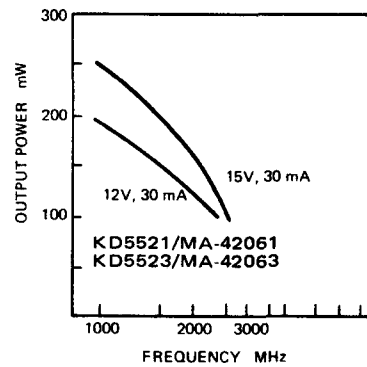

TYPICAL OSCILLATOR TEST CIRCUIT

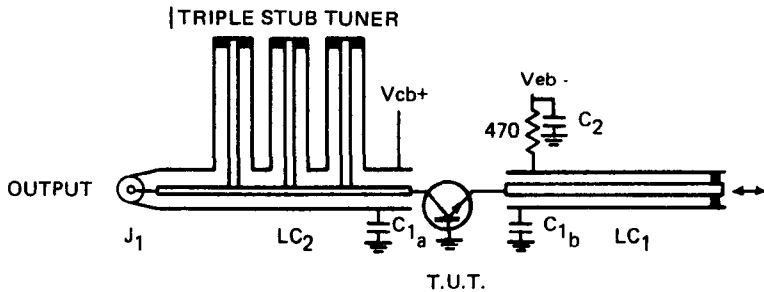

PARTS:

- C_{1a}, C_{1b} — CAP BETWEEN SHORT AND CHASSIS WITH .003 TEFLON DIELECTRIC.
- C_2 — 500 pF UHF SILVER MICA BUTTON
- LC_1 — G.R. 874-D20L
- LC_2 — S305N MICROLAB STUB TUNER
- J_1 — N TYPE COAX. CONN.

MA-42000/K6000 Series

***npn SILICON PLANAR TRANSISTORS
FOR UHF AND MICROWAVE APPLICATIONS***

Bulletin 5204

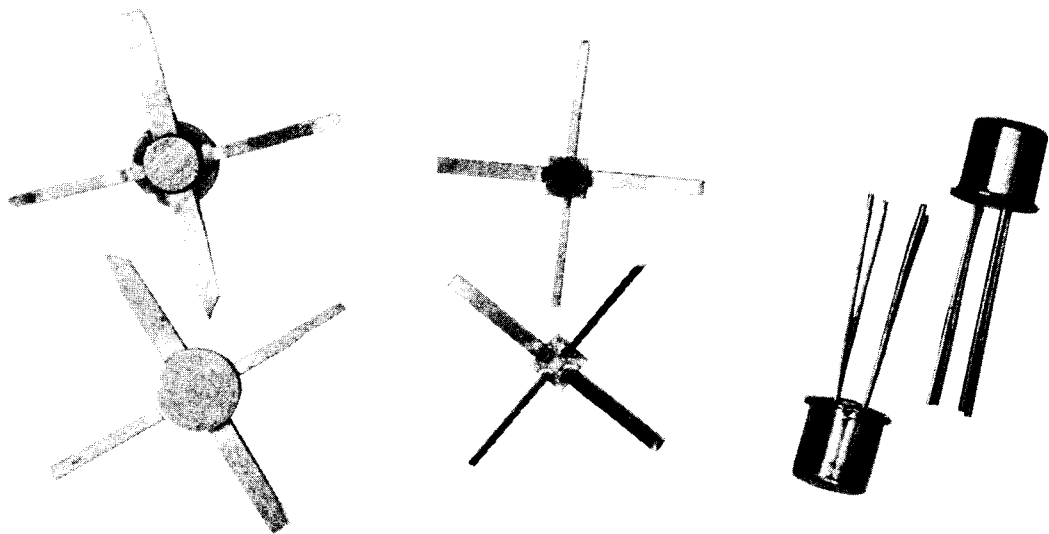

FEATURES

- Low Noise
- Large Dynamic Range
- Gold Metallization
- Low Cost

TYPICAL APPLICATIONS

IF, VHF, UHF, TV and RF Amplifiers.

DESCRIPTION

This series of npn silicon planar transistors is designed to provide the lowest possible noise figure at frequencies from 10 to 700 MHz. These transistors exhibit excellent noise figure vs. current characteristics which results in extremely low noise and wide dynamic range performance. These transistors find wide application in sophisticated radar and communications equipment at VHF/UHF frequencies.

6000 SERIES TRANSISTOR SPECIFICATIONS

Model Number	Case Style	KMC Model Number	Test Frequency MHz	Max. Figure Noise @ I _c dB	Min. Gain dB	Test Current I _c mA	1 dB Compression Pt. @ I _c	Max. 1 dB Compr. Pt. dBm
MA-42001	509	K6001	60	1.0	28	5.0	-2	+16
MA-42002	509	K6002	60	1.5	28	5.0	-2	+16
MA-42003	509	K6003	60	2.0	30	5.0	-2	+16
MA-42004	509	K6011	60	1.5	30	20.0	+12	+16
MA-42005	509	K6012	60	2.0	30	20.0	+12	+16
MA-42006	510		60	4.0	35	40.0	+17	+26
MA-42007	511	KJ6007	450	1.6	18	5.0	-2	+16
MA-42008	511	KJ6008	450	2.0	18	5.0	-2	+16
MA-42009	509	K6009	450	2.5	18	5.0	-2	+16
MA-42010	509	K6021	450	3.0	20	20.0	+11	+16
MA-42011	509	K6022	450	3.5	20	20.0	+11	+16
MA-42010	510		450	3.5	20	40.0	+16	+25
MA-42011	510	—	450	4.0	20	40.0	+16	+25
MA-42010	510	—	450	4.0	20	60.0	+20	+25
MA-42011	510	—	450	4.5	20	60.0	+20	+25
MA-42012	510	—	450	5.0	20	60.0	+20	+25

ELECTRICAL PARAMETERS AND RATINGS (case temperature 25°C)

Symbol	Definition	Conditions	Min.	Typ.	Max.
BV _{cb0}	Collector-base Breakdown voltage	I _c = 10 μA	20V	25V	
BV _{ebo}	Emitter-base breakdown voltage	I _e = 10 μA	3V	3.5V	
I _{cb0}	Collector cut-off current	V _{cb} = 10 V			10 nA
h _{re}	Current transfer ratio	V _{ce} = 10 V, I _c = 5 mA	20		200
C _{cb}	Output Capacitance	V _{cb} = 15V	1.3 pF (510)		1.7 pF (K) (509)
I _c	Collector current				125 mA
P _t	Total Device Dissipation				K pkg. 450 mW, KJ pkg. 750 mW, 510 pkg. 1.2 W

CASE STYLES

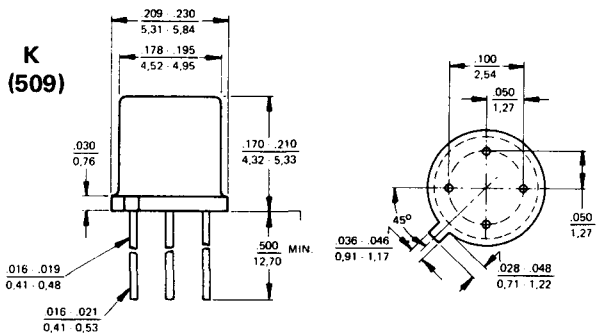

510

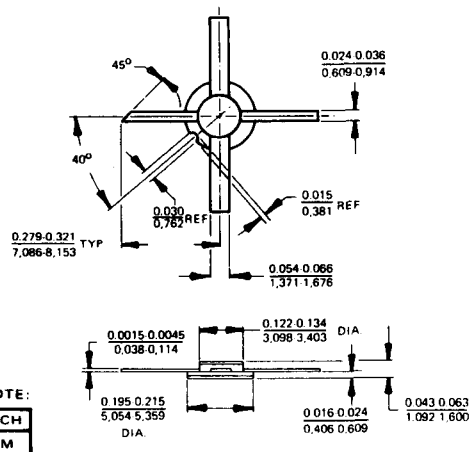

NOTE:
INCH
MM

MA-42000 SERIES GEOMETRY

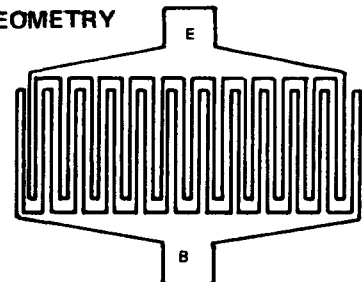

KJ (511)

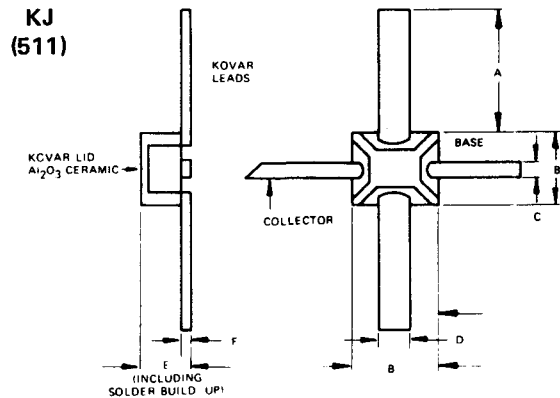

A	B	C	D	E	F
0.230-0.280	0.095-0.105	0.016-0.074	0.036-0.044	0.002-0.006	0.050 MAX.
5.841-7.112	2.413-2.667	0.406-0.809	0.914-1.117	0.050-0.152	1.270

TYPICAL PERFORMANCE CURVES

NOISE FIGURE VS. FREQUENCY

MA-42001/K6001

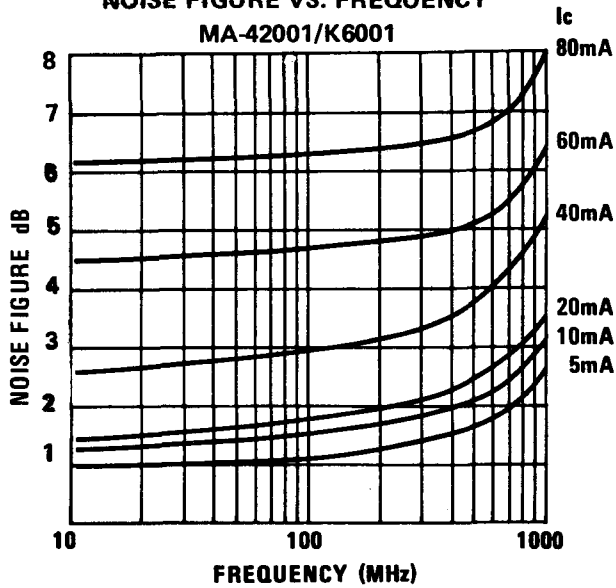

POWER OUTPUT VS. FREQUENCY

MA-42001/K6001

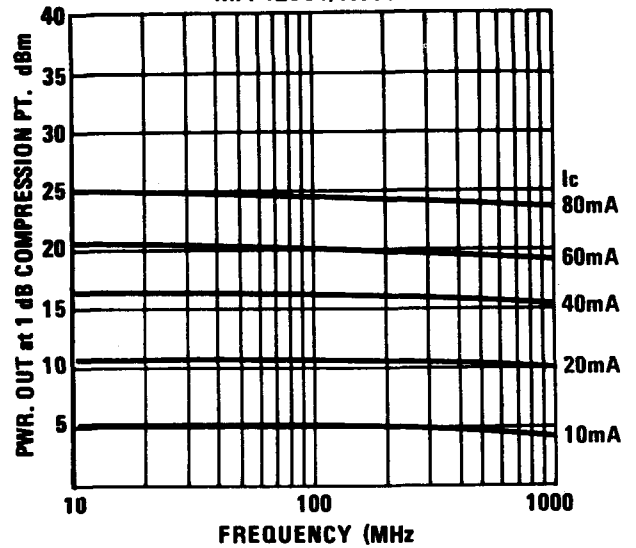

GAIN AT MIN. N.F. VS. FREQUENCY

MA-42001/K6001

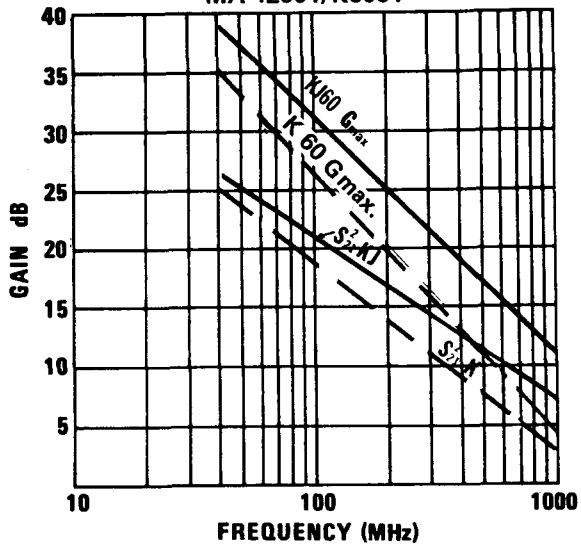

GAIN VS. FREQUENCY

MA-42001/K6001

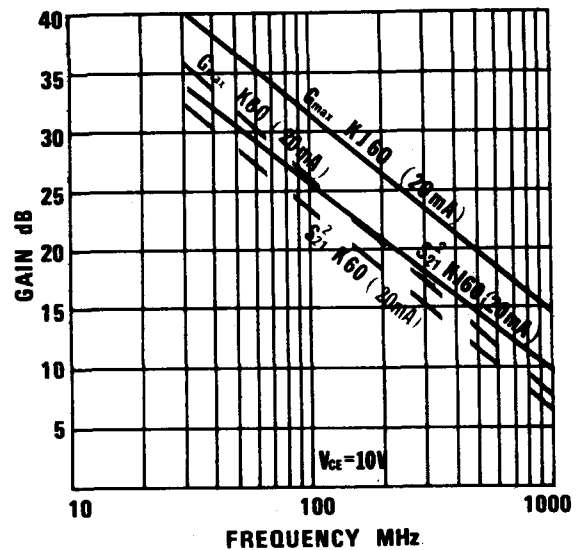

$[S_{21}]^2$ VS. COLLECTOR CURRENT

MA-42001/K6001

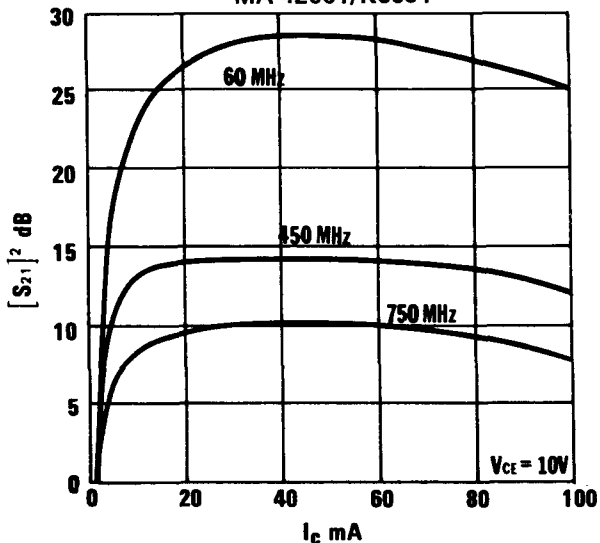

POWER DISSIPATION VS. CASE TEMP.

MA-42001/K6001

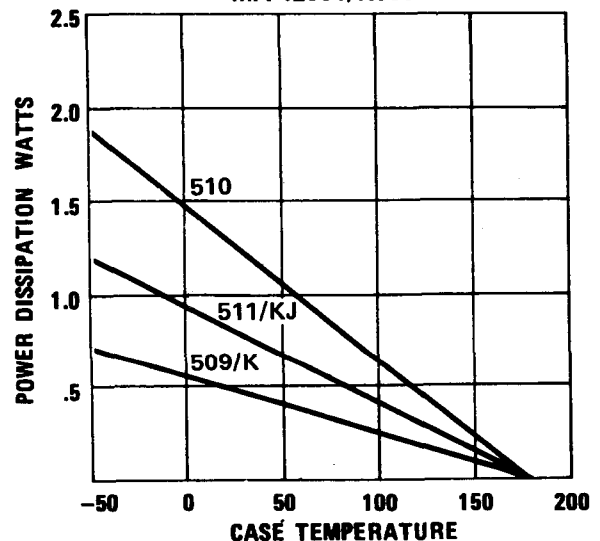

POWER GENERATION AND AMPLIFICATION

S PARAMETER DATA

**MA-42001-509/K6001
S PARAMETERS 10V, 5 mA**

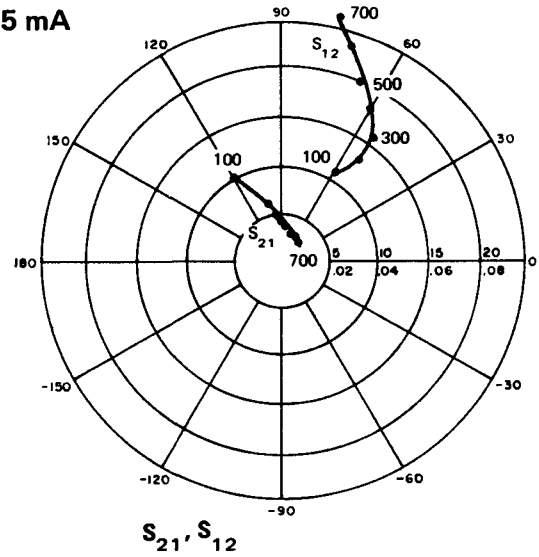
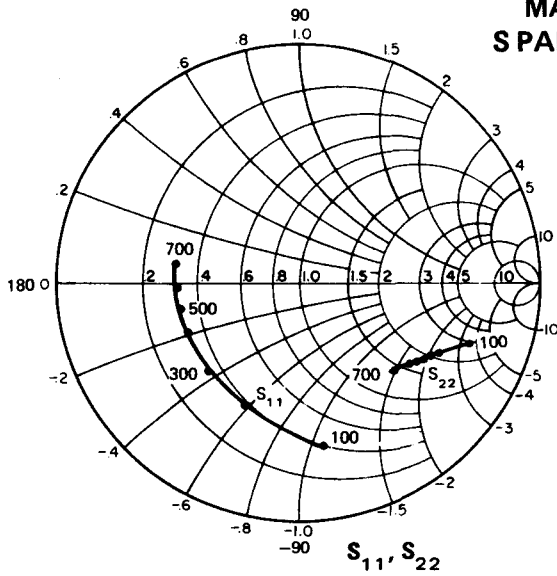

**MA-42007-511/KJ6007
S PARAMETERS 10V, 5 mA**

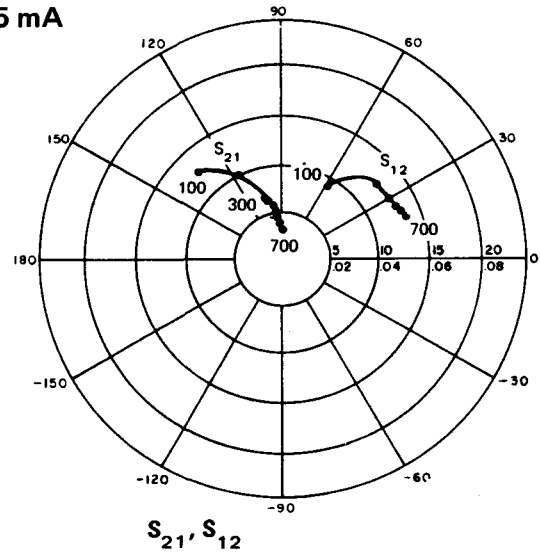
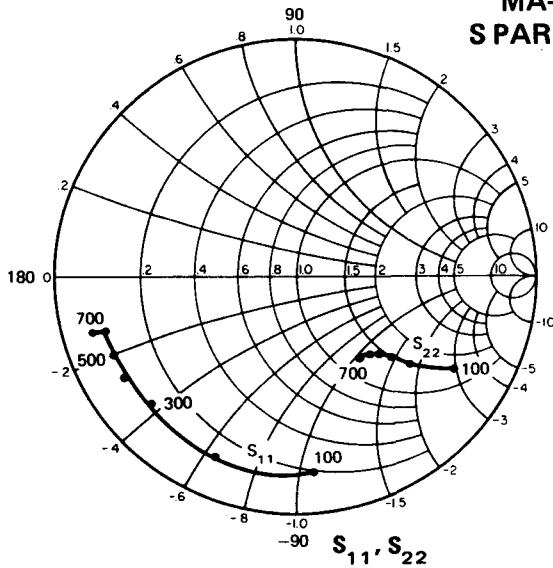

**MA-42010-510
S PARAMETERS 10V, 60 mA**

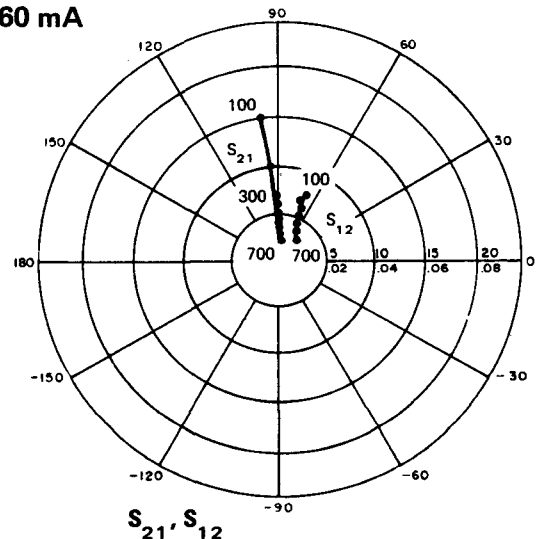
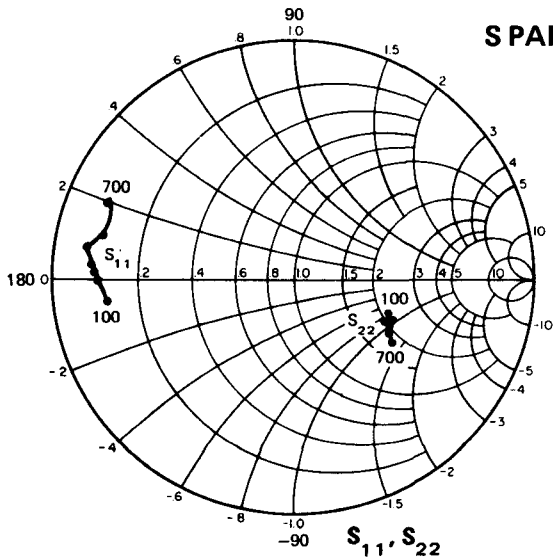

MA-42100

***npn Silicon Planar Transistors for
Microwave Applications***

Bulletin 5205

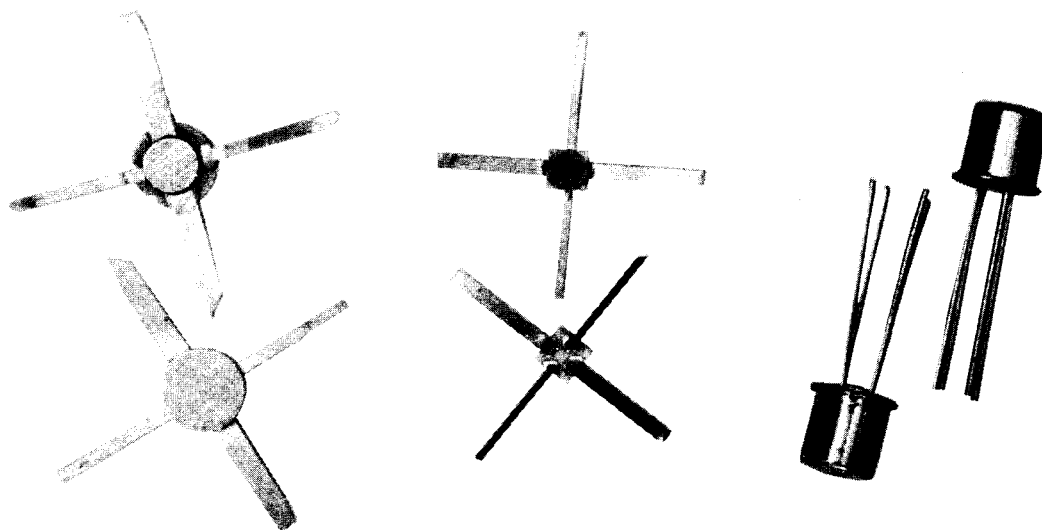

POWER GENERATION
AND AMPLIFICATION

FEATURES

- High Gain
- Low Noise Figure
- Gold Metallization
- Low Cost

DESCRIPTION

The MA-42100 transistor is an npn silicon planar transistor designed for high gain and low noise performance in L-band. The design employs gold metallization resulting in rugged, highly reliable transistor.

TYPICAL APPLICATIONS

RF amplifiers at frequencies through L-band.

MA-42100 TRANSISTOR SPECIFICATIONS

Model Number	Available Case Styles	Noise Figure dB	Typ. Ga (max.) dB	Typ. Ft. GHz	$ S_{21E} ^2$ dB
MA-42100	509, 510 511, 512	2.3 Typ. 2.5 Max.	17 Typ.	4.5	6.0 Min. 7.0 Typ.
Test Conditions		$V_{CE} = 10V$ $I_C = 5 \text{ mA}$ $f = 1 \text{ GHz}$	$V_{CE} = 10V$ $I_C = 10 \text{ mA}$ $f = 1 \text{ GHz}$	$V_{CE} = 10V$ $I_C = 15 \text{ mA}$	$V_{CE} = 10V$ $I_C = 10 \text{ mA}$ $f = 2 \text{ GHz}$

ELECTRICAL PARAMETERS & RATINGS (CASE TEMPERATURE 25°C)

Symbol	Definition	Conditions	Min.	Typ.	Max.
BV_{cbo}	Collector-base breakdown voltage	$I_C = 10 \mu A$	20V	25V	
BV_{ebo}	Emitter-base breakdown voltage	$I_e = 10 \mu A$	3V	3.5V	
I_{cbo}	Collector cut-off current	$V_{cb} = 10V$			100 nA
h_{fe}	Current transfer ratio	$V_{ce} = 10V, I_C = 5 \text{ mA}$	20		200
C_{cb}	Output capacitance	$V_{cb} = 15V$			1.0 pF
I_C	Collector Current				50 mA

CASE STYLES

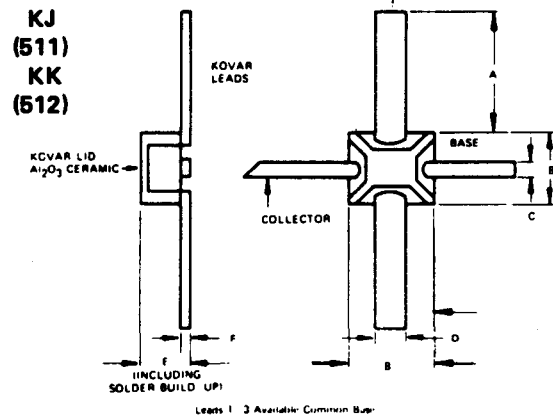
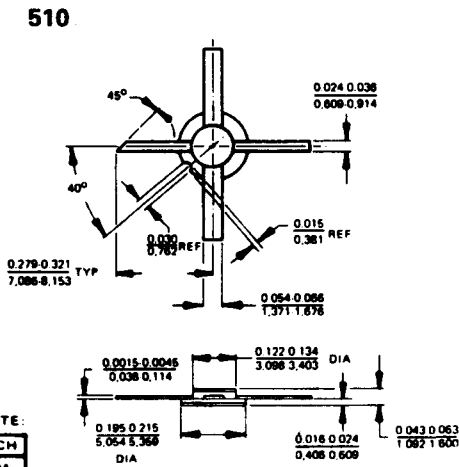
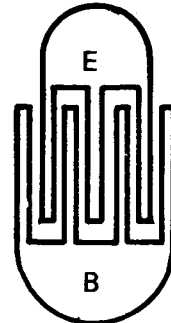
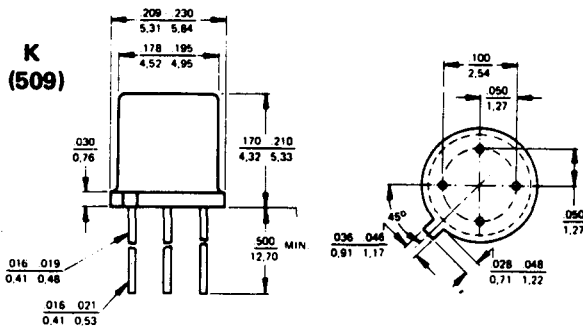

	A	B	C	D	E	F
511	0.230-0.280 5,841-7,112	0.095-0.105 2,413-2,667	0.016-0.074 0,406-0,609	0.036-0.044 0,914-1,117	0.002-0.006 0,050-0,152	0.050 1,270 MAX.
512	0.230-0.280 5,841-7,112	0.065-0.075 1,651-1,905	0.016-0.024 0,406-0,609	0.036-0.044 0,914-1,117	0.002-0.006 0,050-0,152	0.050 1,270 MAX.

S-PARAMETER DATA

MA-42100-511 S-PARAMETERS

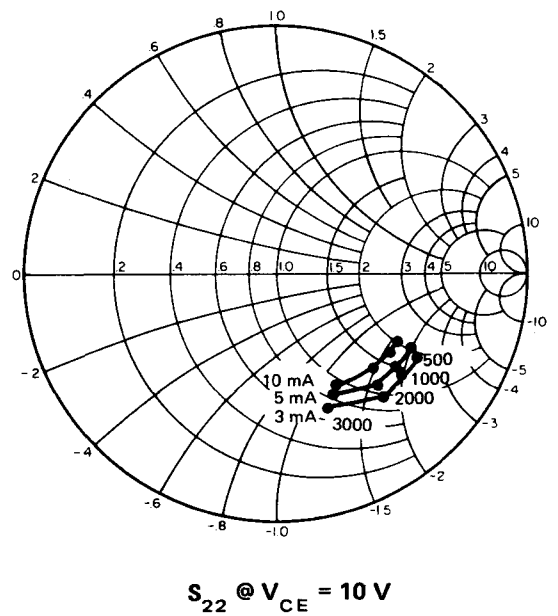
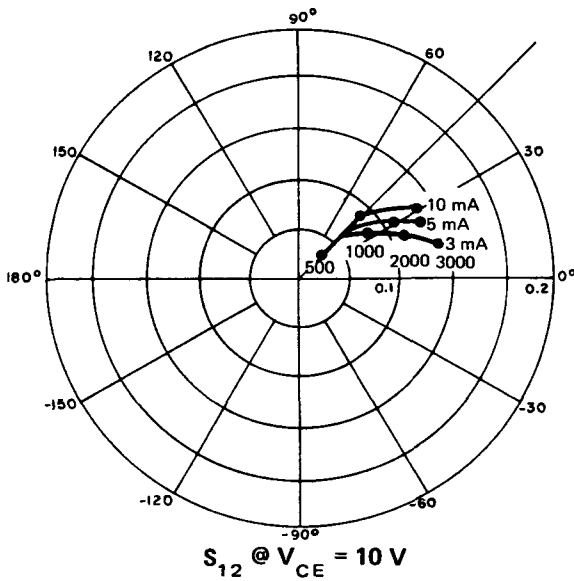
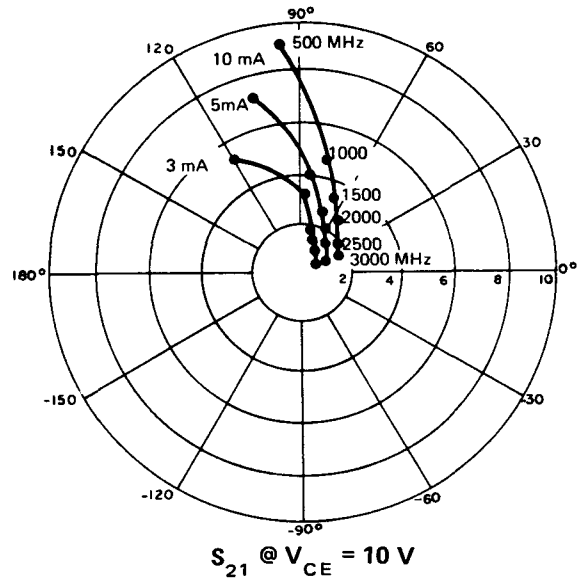
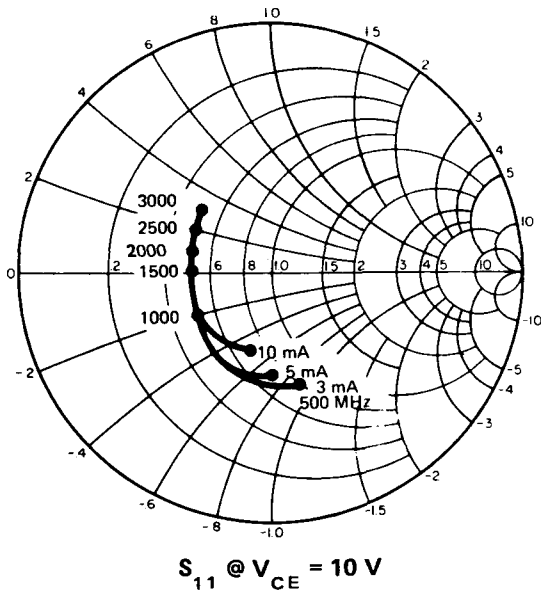

POWER GENERATION
AND AMPLIFICATION

PERFORMANCE CURVES

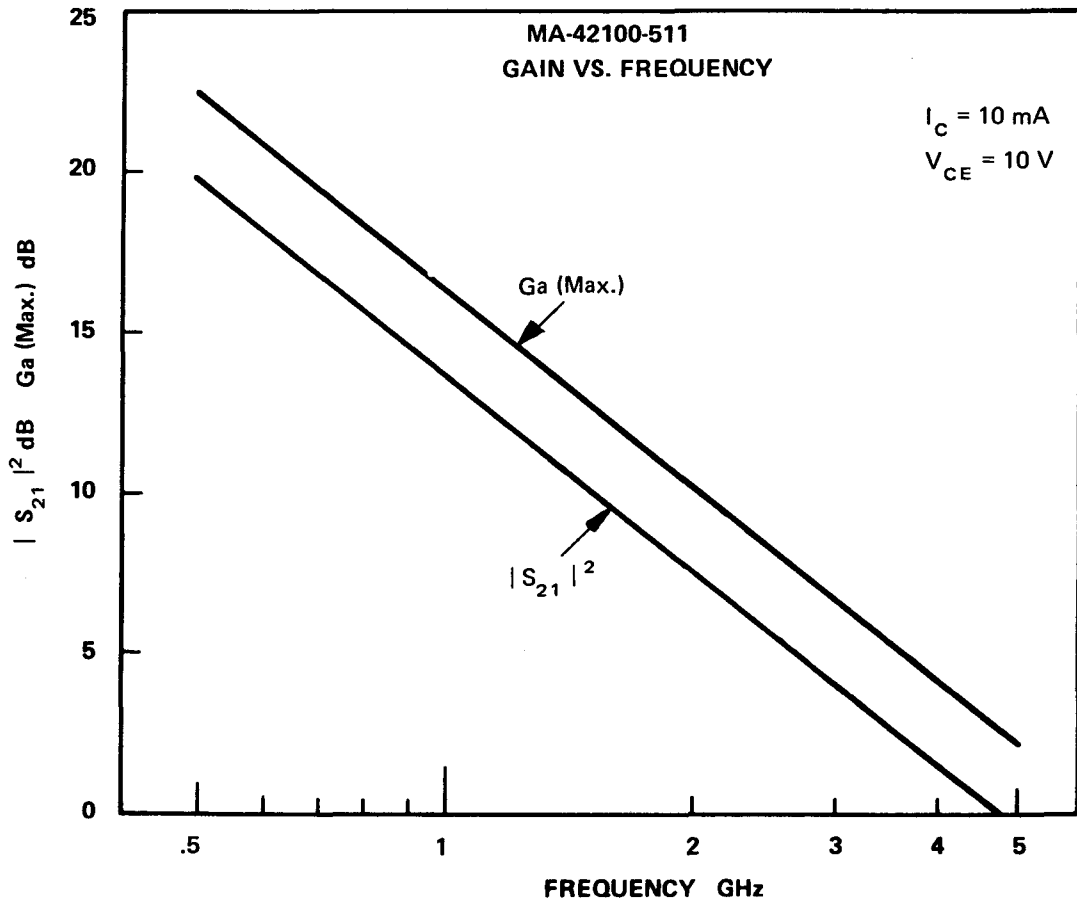

TYPICAL MA-42100 S-PARAMETERS IN 511 PACKAGE

I_C	Bias V_{CE}	Frequency	S_{11}	S_{21}	S_{12}	S_{22}
		MHz				
3 mA	10 V	500	.639 - 83.5	5.061 + 117.2	.053 + 47.5	.710 - 19.9
		1000	.551 - 137.1	3.367 + 86.1	.070 + 31.2	.679 - 31.8
		1500	.540 - 165.3	2.429 + 67.4	.081 + 28.3	.659 - 37.0
		2000	.527 + 177.7	1.867 + 52.0	.089 + 23.6	.634 - 47.2
		2500	.541 + 162.3	1.499 + 37.9	.097 + 20.8	.604 - 54.9
		3000	.556 + 149.9	1.280 + 21.9	.109 + 16.2	.622 - 64.9
5 mA	10 V	500	.582 - 103.2	6.790 + 109.1	.043 + 44.8	.638 - 21.0
		1000	.537 - 151.9	3.948 + 82.1	.058 + 36.1	.616 - 31.1
		1500	.533 - 176.4	2.829 + 64.6	.071 + 34.8	.603 - 35.3
		2000	.527 + 169.8	2.150 + 50.4	.079 + 29.8	.582 - 46.3
		2500	.546 + 155.9	1.722 + 37.4	.090 + 27.9	.555 - 53.4
		3000	.564 + 145.1	1.461 + 21.3	.103 + 22.6	.575 - 63.8
10 mA	10 V	500	.475 - 138.9	8.761 + 98.9	.030 + 46.9	.554 - 21.0
		1000	.514 - 171.1	4.662 + 76.0	.043 + 46.0	.546 - 28.7
		1500	.540 + 171.3	3.160 + 60.6	.057 + 44.1	.548 - 33.1
		2000	.549 + 159.9	2.444 + 47.5	.070 + 40.8	.534 - 43.3
		2500	.575 + 149.6	1.912 + 35.8	.081 + 37.0	.513 - 51.3
		3000	.593 + 138.9	1.634 + 21.4	.094 + 31.8	.528 - 61.2

All specifications are subject to change without notice.

MA-42110

***n*pn SILICON PLANAR TRANSISTORS FOR UHF AND MICROWAVE APPLICATORS**

Bulletin 5206

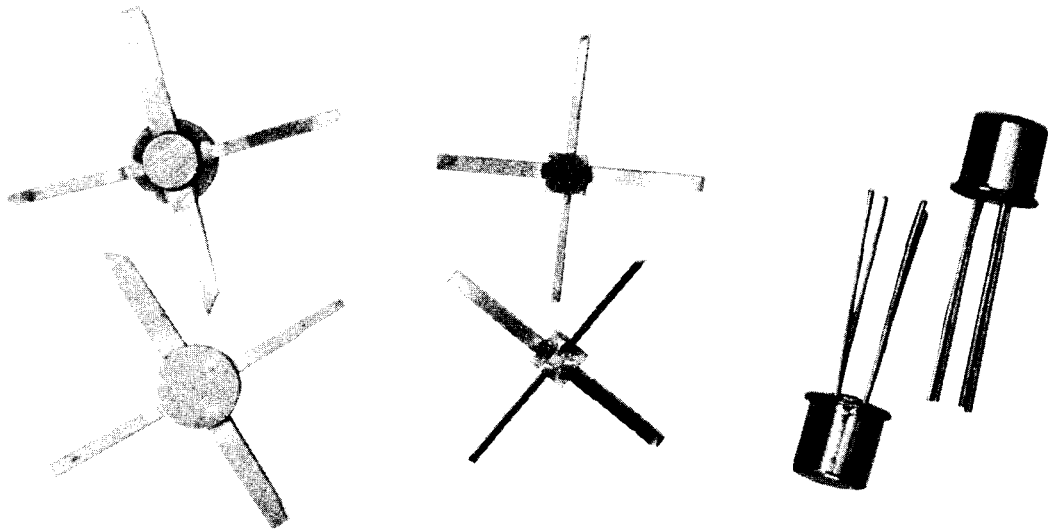

FEATURES

- Very low noise figure
- Wide dynamic range
- High gain
- Gold metallization
- Low cost

TYPICAL APPLICATIONS

RF and IF amplifiers at frequencies through L-Band

DESCRIPTION

The MA-42110 transistor is an npn silicon planar transistor designed to give very low noise figure and wide dynamic range in the UHF and L-Band ranges. Gold metallization employed in the construction of the device results in a rugged, highly reliable transistor.

POWER GENERATION
AND AMPLIFICATION

MA-42110 TRANSISTOR SPECIFICATIONS

Model Number	Case Style	Noise Figure dB	Typ. Ga (Max.) dB	Typ. Ft. GHz	$ S_{21E} ^2$ dB
MA-42110	509, 511	1.2 Typ.	22	4.5	10 Min.
	510, 512	1.5 Max.			12 Typ.
Test Conditions	$V_{CE} = 10V$	$V_{CE} = 10V$ $I_C = 5 \text{ mA}$ $f = 450 \text{ MHz}$	$V_{CE} = 10V$ $I_C = 20 \text{ mA}$ $f = 450 \text{ MHz}$	$V_{CE} = 10V$ $I_C = 50 \text{ mA}$	$V_{CE} = 10V$ $I_{CE} = 20 \text{ mA}$ $f = 1 \text{ GHz}$

ELECTRICAL PARAMETERS & RATINGS (case temperature 25°C)

Symbol	Definition	Conditions	Min.	Typ.	Max.
BV_{cbo}	Collector-base breakdown voltage	$I_C = 10 \mu A$	20V	25V	
BV_{ebo}	Emitter-base breakdown	$I_e = 10 \mu A$	3V	3.5V	
I_{cbo}	Collector cut-off current	$V_{cb} = 10V$			100nA
h_{fe}	Current transfer ratio	$V_{ce} = 10V, I_C = 5 \text{ mA}$	20		200
C_{cb}	Output capacitance	$V_{cb} = 15V$			1.7pF
$I_C \text{ max.}$	Max. collector current				125mA

CASE STYLES

**K
(509)**

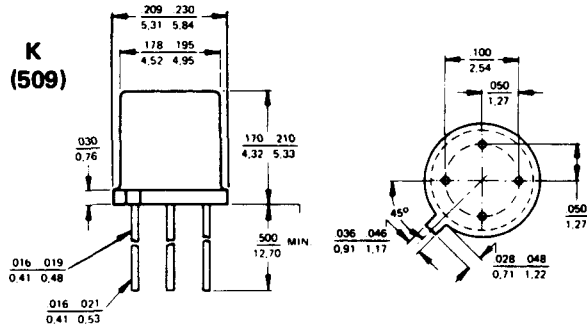

510

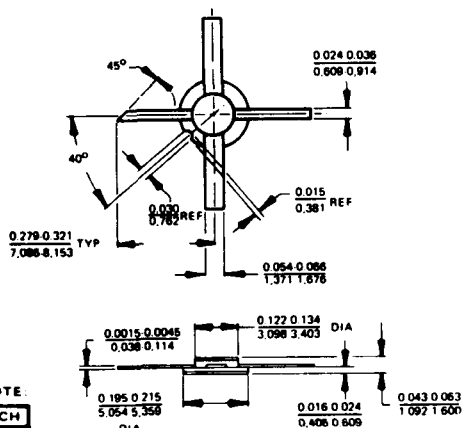

NOTE:
INCH
MM

MA-42110 GEOMETRY

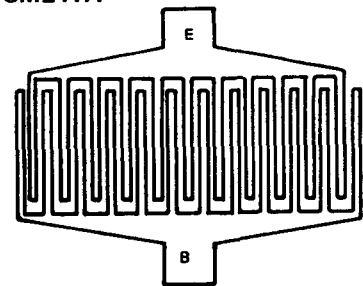

**KJ
(511)
KK
(512)**

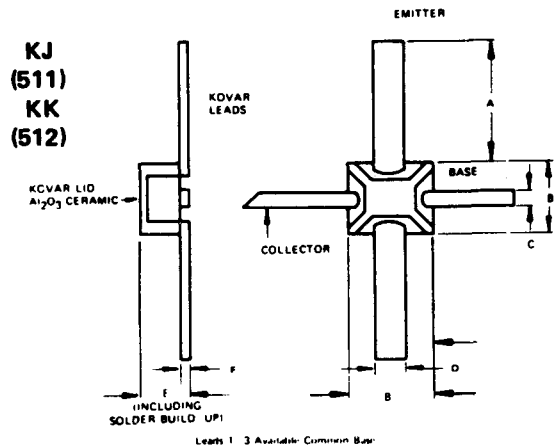

	A	B	C	D	E	F
511	0.230-0.280 5,841-7,112	0.095-0.105 2,413-2,667	0.016-0.074 0,406-0,609	0.036-0.044 0,914-1,117	0.002-0.006 0,050-0,152	0.050 1,270 MAX.
512	0.230-0.280 5,841-7,112	0.065-0.075 1,651-1,905	0.016-0.024 0,406-0,609	0.036-0.044 0,914-1,117	0.002-0.006 0,050-0,152	0.050 1,270 MAX.

S-PARAMETER DATA

MA-42110-511 S PARAMETERS

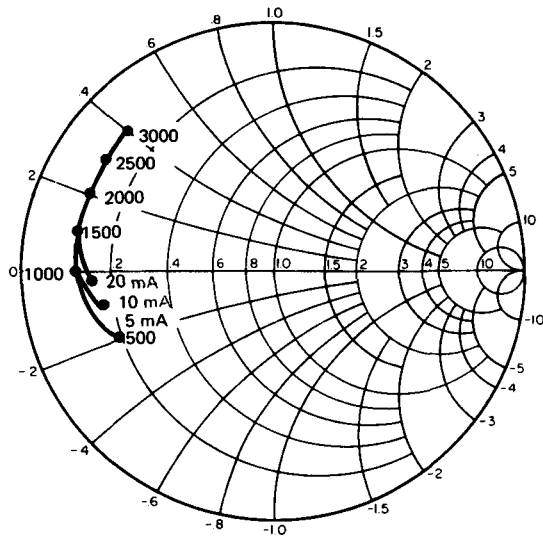

$S_{11} @ V_{CE} = 10 \text{ V}$

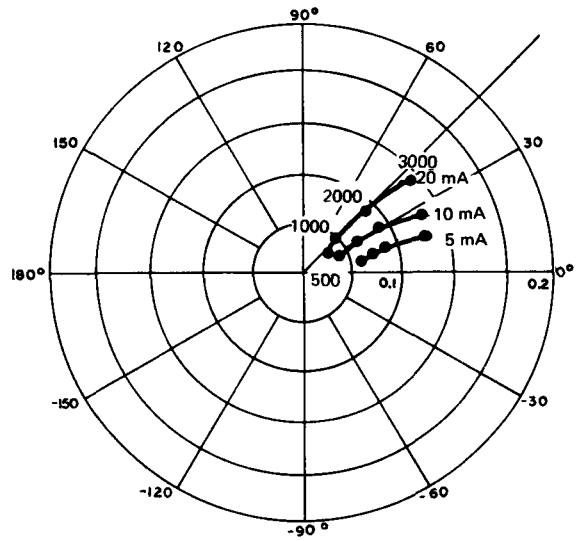

$S_{12} @ V_{CE} = 10 \text{ V}$

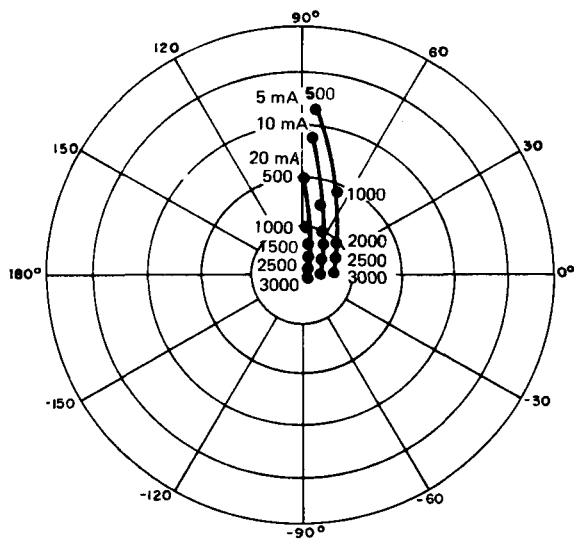

$S_{21} @ V_{CE} = 10 \text{ V}$

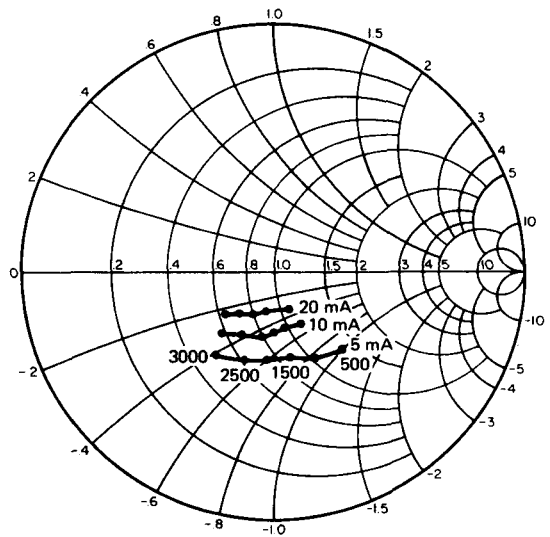

$S_{22} @ V_{CE} = 10 \text{ V}$

POWER GENERATION AND AMPLIFICATION

PERFORMANCE CURVES

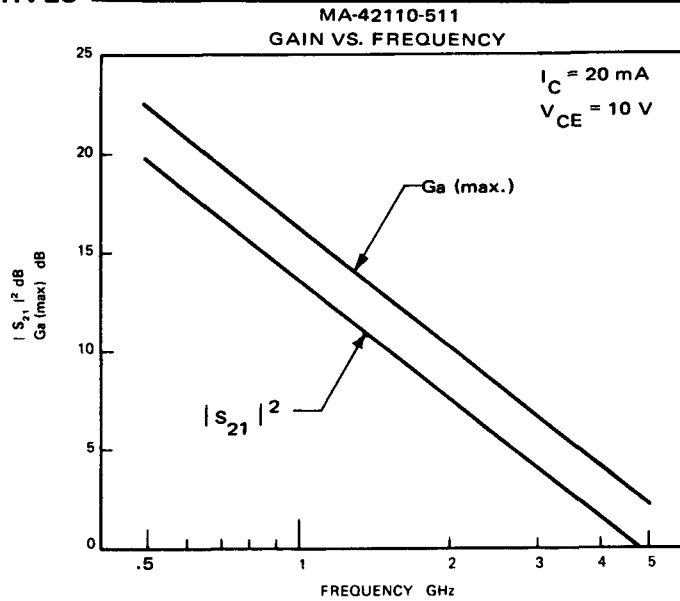

TYPICAL MA-42110 S-PARAMETERS IN 511 PACKAGE

Bias		FREQ. MHz	S_{11}	S_{21}	S_{12}	S_{22}
I_C	V_{CE}					
5mA	10V	500	.724 - 157.4	4.126 + 91.2	.067 + 19.0	.423 - 44.4
		1000	.820 + 176.8	2.220 + 64.8	.068 + 11.6	.417 - 61.6
		1500	.827 + 159.6	1.464 + 45.9	.069 + 14.5	.437 - 78.0
		2000	.816 + 149.5	1.119 + 30.4	.069 + 17.5	.459 - 96.7
		2500	.843 + 139.9	.845 + 16.2	.075 + 23.4	.498 - 114.0
		3000	.839 + 128.6	.696 + 2.3	.089 + 24.9	.560 - 129.4

Bias		FREQ. MHz	S_{11}	S_{21}	S_{12}	S_{22}
I_C	V_{CE}					
10mA	10V	500	.725 - 170.4	5.597 + 88.1	.045 + 25.3	.270 - 61.3
		1000	.814 + 170.3	2.891 + 65.0	.052 + 28.1	.254 - 77.9
		1500	.821 + 155.5	1.927 + 48.3	.062 + 32.0	.279 - 92.3
		2000	.811 + 146.6	1.466 + 34.0	.073 + 33.7	.307 - 109.9
		2500	.835 + 137.7	1.117 + 21.0	.085 + 34.5	.355 - 124.4
		3000	.830 + 126.8	.934 + 6.7	.101 + 31.6	.422 - 137.5

Bias		FREQ. MHz	S_{11}	S_{21}	S_{12}	S_{22}
I_C	V_{CE}					
20mA	10V	500	.719 - 176.2	6.539 + 86.0	.035 + 33.2	.196 - 81.1
		1000	.806 + 167.1	3.274 + 65.4	.048 + 40.2	.179 - 98.5
		1500	.782 + 153.2	2.192 + 49.6	.061 + 42.7	.208 - 111.3
		2000	.809 + 145.0	1.666 + 36.1	.076 + 41.4	.237 - 125.3
		2500	.832 + 136.3	1.271 + 24.1	.090 + 39.4	.285 - 136.4
		3000	.827 + 125.8	1.075 + 9.9	.108 + 34.9	.351 - 146.4

Gallium Arsenide IMPATT Diodes

MA-46021 through MA-46032

0.5 and 1.0 Watt

X-Band

DESCRIPTION

These Gallium Arsenide IMPATT Diodes (Impact Ionization Avalanche Transit Time) are junction devices that operate with a reverse bias sufficient to cause avalanche breakdown (typically 70 V and 125-150 mA). In such a diode, carriers are produced by avalanche multiplication. The negative resistance at microwave frequencies is the result of the current phase delay between the voltage and the current. This is produced by both carrier generation and the carrier drift through the active layer. In an appropriate circuit, these diodes will oscillate, producing a microwave output at an efficiency greater than 10%.

APPLICATIONS

These IMPATT diodes are useful as CW oscillators with up to 1 watt output power. They are ideally suited as final stage amplifiers for communication systems in the 10.7-11.7 GHz frequency range.

FEATURES

- Direct conversion from dc to RF with >10% efficiency
- Low AM and FM noise
- Low thermal resistance
- Low cost

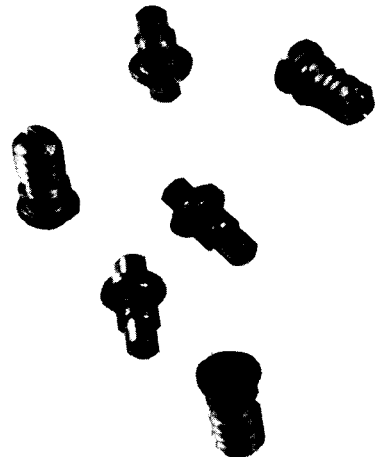

MAXIMUM RATINGS

Storage Temperature	-65°C to 150°C
Junction Operating Temperature	200°C ⁴
Power Dissipation	$\frac{200^\circ\text{C} - T_{\text{Case}}}{\theta_{\text{JC}}}$

ELECTRICAL SPECIFICATIONS @ 25°C

Model Number	Case Style	Operating Frequency GHz		Power ¹ Output W		Efficiency ² %		Thermal ³ Resistance °C/W		
		Min.	Max.	Min.	Typ.	Min.	Typ.	Max.	Typ.	
1 Watt Devices										
MA-46027	30	8.0	9.5	1.0	1.3	10	12	18	14	
MA-46028	30	9.5	11.0	1.0	1.3	10	12	18	14	
MA-46029	30	11.0	12.5	1.0	1.3	10	12	18	14	
MA-46030	111	8.0	9.5	1.0	1.3	10	12	18	14	
MA-46031	111	9.5	11.0	1.0	1.3	10	12	18	14	
MA-46032	111	11.0	12.5	1.0	1.3	10	12	18	14	
0.5 Watt Devices										
MA-46021	30	8.0	9.5	0.5	0.7	10	12	30	24	
MA-46022	30	9.5	11.0	0.5	0.7	10	12	30	24	
MA-46023	30	11.0	12.5	0.5	0.7	10	12	30	24	
MA-46024	111	8.0	9.5	0.5	0.7	10	12	30	24	
MA-46025	111	9.5	11.0	0.5	0.7	10	12	30	24	
MA-46026	111	11.0	12.5	0.5	0.7	10	12	30	24	

NOTES:

- Output power is measured in a tunable test mount. (See Outline Drawing)
- Efficiency = $\frac{\text{RF Power Out}}{\text{dc Power In}}$
- Thermal resistance is obtained by measuring the change in breakdown voltage with dc current.
- Although the diode is capable of withstanding a junction temperature of more than 275°C during operation, reliability may be adversely affected. The maximum recommended junction temperature of 200°C has been chosen to provide long term reliable operation.

TYPICAL OPERATING PARAMETERS @ 25°C

Model ¹ Number	Breakdown Voltage Volts	Operating Voltage Volts	Operating Current mA	Junction ² Capacity @ 0 V Bias
1 Watt Devices				
MA-46027	55	70	125	5.0
MA-46028	50	65	150	4.5
MA-46029	45	60	150	4.0
MA-46030	55	70	125	5.0
MA-46031	50	65	150	4.5
MA-46032	45	60	150	4.0
0.5 Watt Devices				
MA-46021	55	70	75	4.0
MA-46022	50	65	75	3.5
MA-46023	45	60	75	3.0
MA-46024	55	70	75	4.0
MA-46025	50	65	75	3.5
MA-46026	45	60	75	3.0

- NOTES:** 1. Package capacity and inductance per Outline Drawings. 2. The capacitance at breakdown is approximately 0.1 this value.

APPLICATION NOTES

- 1) Since all IMPATT devices are susceptible to tuning induced failures (burnout), it is always necessary to reduce the bias voltage before tuning for maximum power.
- 2) Caution: A severe load mismatch should be avoided to minimize RF burnout.
- 3) The power supply should be carefully regulated to minimize voltage transients.
- 4) Applications assistance and engineering drawings of the test fixtures are available upon request.
- 5) Anode Heat sink

TEST CIRCUIT

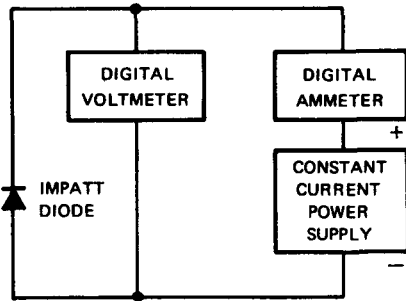

TEST CIRCUIT

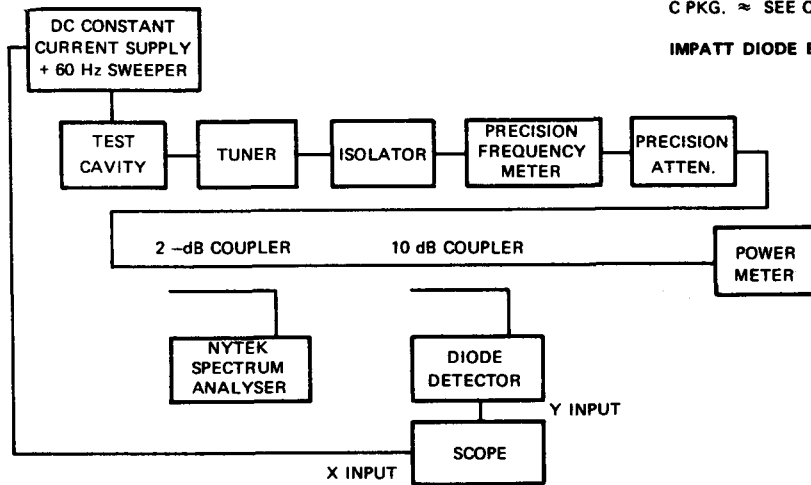

TEST SET-UP FOR MEASUREMENT OF POWER, FREQUENCY AND TUNING CHARACTERISTICS OF GaAs IMPATT DIODES

IMPATT DIODE EQUIVALENT CIRCUIT

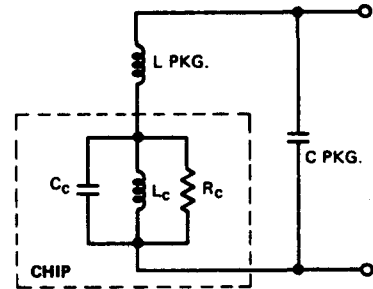

TYPICALLY

$C_c \approx$ SEE TABLE

$L_c \approx$ 0.5 nH

$R_c \approx$ 1-10 OHMS

L PKG. \approx SEE OUTLINE DRAWING

C PKG. \approx SEE OUTLINE DRAWING

IMPATT DIODE EQUIVALENT CIRCUIT

CASE STYLES

Not to scale.

30

DIM.	INCHES		MM	
	MIN.	MAX.	MIN.	MAX.
A	.119	.127	3.02	3.22
B	.060	.064	1.52	1.63
C	.205	.225	5.21	5.72
D	.085	.097	2.16	2.46
E	.060	.064	1.52	1.63
F	.060	.064	1.52	1.63
G	.016	.024	.41	.61
H	.079	.083	2.01	2.11

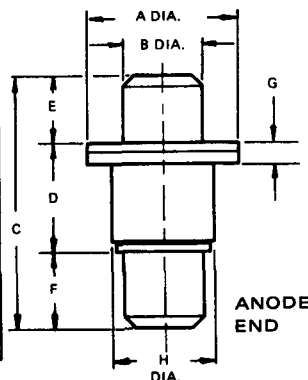

111

DIM.	INCHES		MM	
	MIN.	MAX.	MIN.	MAX.
A	.119	.127	3.02	3.22
B	.098	.102	2.49	2.59
C	.188	.208	4.78	5.28
D	.057	.071	1.45	1.80
E	.016	.024	.41	.61
F	.009	.011	.23	.28
G	.030	.040	.76	1.02
H	.015	.025	.38	.64

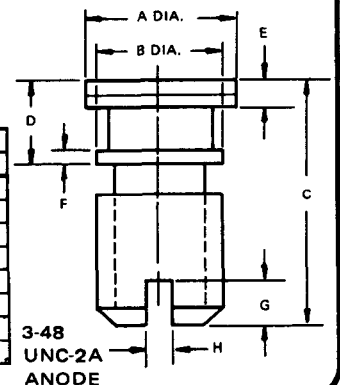

3-48
UNC-2A
ANODE

TYPICAL PERFORMANCE CHARACTERISTICS @ 25°C

TYPICAL PERFORMANCE DATA OF X-BAND IMPATT DIODES - MA-46027

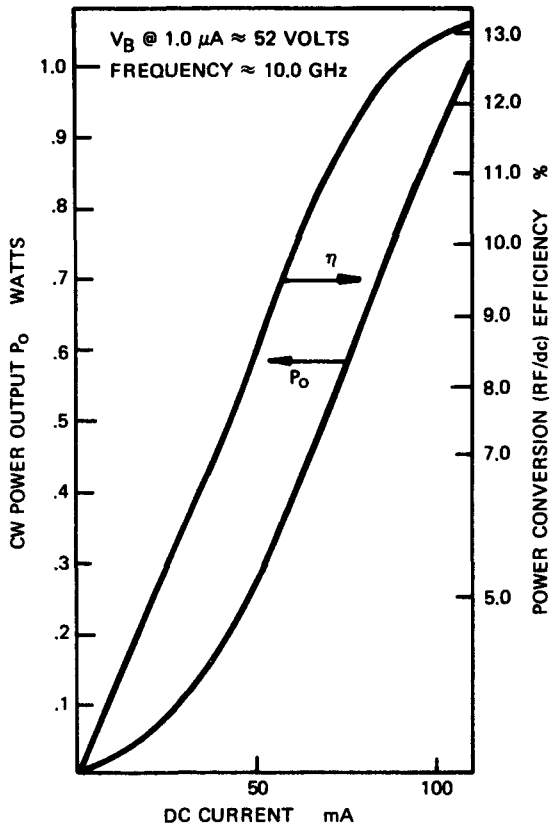

TYPICAL FREQUENCY CHANGE WITH DC CURRENT 50 mA

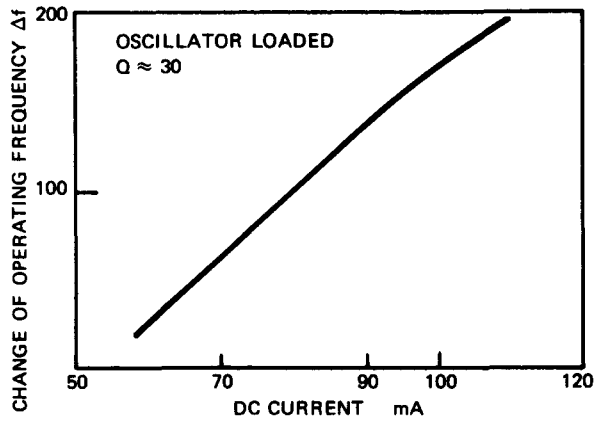

TYPICAL AM NOISE VS. FREQUENCY FOR MA-46028

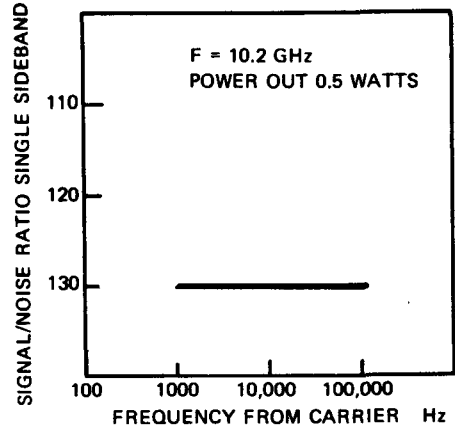

TYPICAL BIAS VOLTAGE CHANGE WITH CURRENT AT 25°C

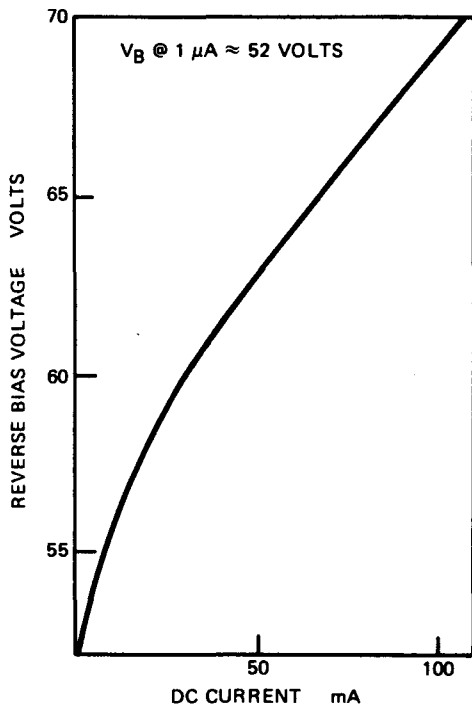

TYPICAL POWER OUTPUT VS. FREQUENCY

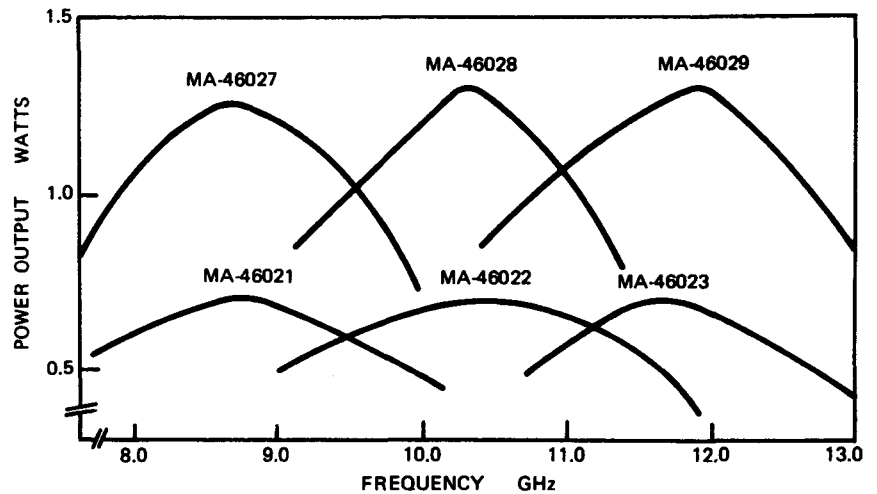

Tunnel Diodes For Microwave Amplifier And Oscillator Applications

Bulletin 5052

POWER GENERATION
AND AMPLIFICATION

***Germanium Tunnel Diodes
for Microwave Amplifiers***

***Gallium Arsenide Tunnel Diodes
for Microwave Oscillators***

Microwave Associates, Inc. 

FEATURES

Germanium Tunnel Diodes for Microwave Amplifiers

- High gain bandwidth product
- Low DC power consumption
- Excellent Temperature and Gain Stability
- Amplifier diodes available with noise figure under 5 dB up to 16 GHz
- High reliability versions are available

Gallium Arsenide Tunnel Diodes for Microwave Oscillators

- Low DC power consumption
- Excellent frequency stability
- High DC to microwave conversion efficiency
- Output power from tunnel diode oscillators is sufficient to provide local oscillator power for back diode mixers through X-Band.
- High resistance to radiation damage

Germanium Tunnel Diodes for Microwave Amplifier Applications

MA-4C250 Series
MA-4C260 Series
MA-4C270 Series

This series of Germanium Tunnel Diodes is recommended for use in amplifiers into Ku-band. The MA-4C250, 260 and 270 series are representative of the modifications in characteristics which can be made.

CASE STYLES

187
TYPE H

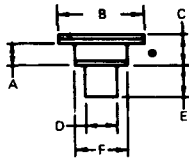

TYPICAL
 $L_p = 0.1 \text{ nH}$
 $C_p = 0.35 \text{ pF}$

DIM.	INCHES		MM	
	MIN.	MAX.	MIN.	MAX.
A	.013	.017	.330	.431
B	.078	.082	1.98	2.08
C	.023	.032	.584	.813
D	.024	.026	.609	.660
E	.029	.031	.736	.787
F	.048	.052	1.22	1.32

190
TYPE D

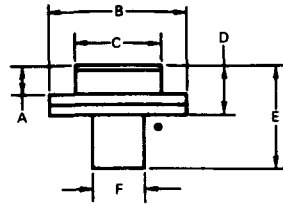

TYPICAL
 $L_p = 0.1 \text{ nH}$
 $C_p = 0.36 \text{ pF}$

DIM.	INCHES		MM	
	MIN.	MAX.	MIN.	MAX.
A	.015	.019	.381	.482
B	.078	.082	1.98	2.08
C	.045	.055	1.14	1.40
D	.027	.034	.685	.863
E	.048	.059	1.22	1.50
F	.025	.029	.635	.736

● Denotes Cathode End

Not to scale.

MAXIMUM RATINGS @ $T_A = 25^\circ\text{C}$ (unless otherwise specified)

Incident CW RF Power	20 mW
DC Current	5.0 mA
Temperature Range	-65°C to $+100^\circ\text{C}$

ENVIRONMENTAL RATINGS PER MIL-STD-750

	Method	Levels
Temperature, Storage	1031	See max. Rating
Temperature, Operating	—	See max. Rating
		10 cycles
Temperature Cycling	1051	See max. Rating
Shock	2016	1200 g's
Vibration	2056	20 g's
Constant Acceleration	2006	20,000 g's
Humidity	1021	10 days

ELECTRICAL SPECIFICATIONS @ $T_A = 25^\circ\text{C}$ Min.

M/A ¹ Type	KMC Type	Resistive Cutoff Frequency GHz	Junction Capacitance pF		Typ. R_m Ohms	Typ. R_s Ohms	K	
			Typ.	Max.			Max.	Typ.
MA-4C250	G25001	2.5	5.5	6.0	105	2	1.30	1.25
MA-4C251	G50001	5.0	2.5	3.0	105	2	1.35	1.25
MA-4C252	G10001	10.0	1.0	1.3	105	3	1.40	1.30
MA-4C253	G15001	15.0	.70	0.9	105	3	1.45	1.35
MA-4C254	G20001	20.0	.45	0.8	105	4	1.45	1.40
MA-4C255	G25X01	25.0	.30	0.6	105	5	1.45	1.40
MA-4C256	G30001	30.0	.25	0.4	105	5	1.50	1.40
MA-4C257	G40001	40.0	.17	0.3	105	6	—	1.45
MA-4C258	G50X01	50.0	.12	0.2	105	7	—	1.45

I_p (mA) = $1.0 \pm 10\%$.

POWER GENERATION
AND AMPLIFICATION



MICROWAVE ASSOCIATES, INC. BURLINGTON, MASSACHUSETTS

ELECTRICAL SPECIFICATIONS (CONT.)

M/A ¹ Type	KMC Type	Min. Cutoff Frequency GHz	Resistive Junction Capacitance pF		Typ. R _m Ohms	Typ. R _s Ohms	Max.	K	Typ.
			Typ.	Max.					
MA-4C260	G25015	2.5	5.4	6.0	75	2	1.30	1.20	
MA-4C261	G50015	5.0	2.7	3.1	75	2	1.30	1.25	
MA-4C262	G10015	10.0	1.1	1.4	75	3	1.35	1.25	
MA-4C263	G15015	15.0	.72	0.9	75	3	1.40	1.30	
MA-4C264	G20015	20.0	.46	0.75	75	4	1.40	1.35	
MA-4C265	G25X15	25.0	.32	0.6	75	5	1.45	1.40	
MA-4C266	G30015	30.0	.27	0.4	75	5	1.45	1.40	
MA-4C267	G40015	40.0	.18	0.3	75	6	—	1.45	
MA-4C268	G50X15	50.0	.13	0.2	75	7	—	1.45	

I_p (mA) = 1.5 ± 10%.

M/A ¹ Type	KMC Type	Min. Cutoff Frequency GHz	Resistive Junction Capacitance pF		Typ. R _m Ohms	Typ. R _s Ohms	Max.	K	Typ.
			Typ.	Max.					
MA-4C270	G25002	2.5	6.9	7.5	60	2	1.30	1.20	
MA-4C271	G50002	5.0	3.5	4.0	60	2	1.30	1.25	
MA-4C272	G10002	10.0	1.3	1.6	60	3	1.35	1.30	
MA-4C273	G15002	15.0	.90	1.2	60	3	1.40	1.30	
MA-4C274	G20002	20.0	.55	1.0	60	4	1.40	1.35	
MA-4C275	G25X02	25.0	.45	0.9	60	4	1.45	1.40	
MA-4C276	G30002	30.0	.30	0.7	60	5	1.45	1.40	
MA-4C277	G40002	40.0	.22	0.5	60	5	—	1.45	
MA-4C278	G50X02	50.0	.15	0.3	60	6	—	1.45	

I_p (mA) = 2.0 ± 10%.

NOTE:

1. Add suffix D or H after M/A type number to specify case style.

THEORETICAL TUNNEL DIODE AMPLIFIER NOISE FIGURE IN dB

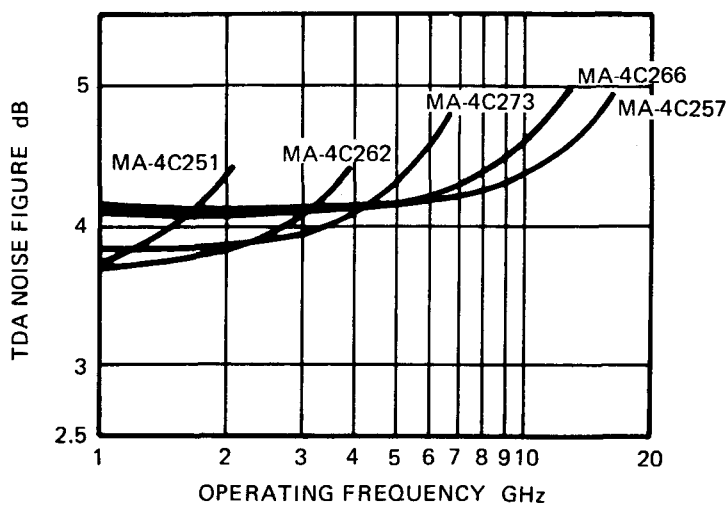

Tunnel Diode Amplifier Application Notes

T. D. FORWARD STATIC IV CHARACTERISTICS

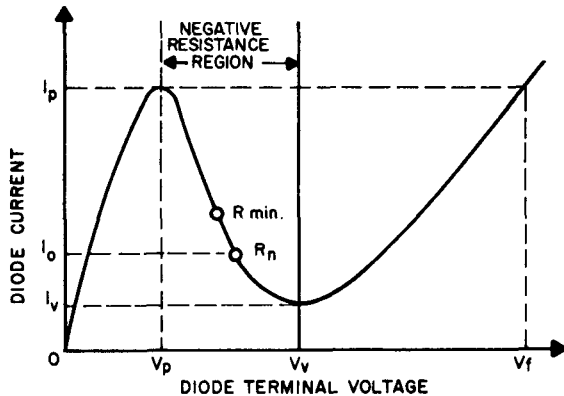

EQUIVALENT CIRCUIT

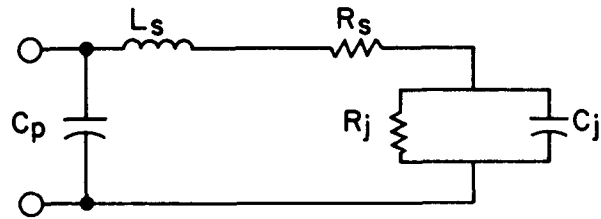

NOISE FIGURE

Tunnel Diode amplifier noise figure in db can be calculated using the formula:

$$NF (db) = -10 \left[\log (1 + K) + \log \left(\frac{|R_n| + R_s}{|R_n|} \right) + \log \left(\frac{f r_o^2}{f r_o^2 \cdot f^2} \right) \right]$$

GAIN BANDWIDTH

The voltage gain of a reflection type tunnel diode amplifier is given in its simplest form by:

$$G_v = \left| \frac{Z_L - Z_d}{Z_L + Z_d} \right|$$

where Z_L is the characteristic impedance of the load and Z_d is the RF impedance of the diode. The maximum gain bandwidth that can be achieved by such an amplifier in the idealized case where the diode is assumed to consist of a shunt capacitance across a negative resistance terminating a line and tuned by a shunt inductance is:

$$G_v \cdot BW \approx \frac{R_L - R_d}{R_L + R_d} \cdot \frac{f_o}{Q} \approx \left| \frac{R_L - R_d}{2\pi R_L R_d C_d} \right|$$

where:

R_L = Resistive portion of load impedance

R_d = Overall equivalent RF resistance of diode

C_d = Equivalent capacitance of diode i.e.; capacitive portion of Z_d

$$Q = \text{Overall circuit } Q \approx \omega C \frac{R_L R_d}{R_L + R_d}$$

DEFINITIONS:

$$R_{min} = |R_j| + |R_s|$$

R_j = the junction negative resistance at the point on the I-V curve which makes R_j most negative.

$$f_{RO} = \frac{1}{2\pi R_{min} C_j} \sqrt{\frac{R_m}{R_s} - 1}$$

$$f_{XO} = \frac{1}{2\pi R_{min} C_j} \sqrt{\frac{R_m^2 C_i}{L_s} - 1}$$

DYNAMIC RANGE

The dynamic range of an amplifier is the input signal variation over which the amplifier functions effectively. The lower limit is determined by noise figure; the upper limit by saturation. To compare the effect of semiconductor materials on dynamic range, consider gallium antimonide, germanium, and gallium arsenide diodes with the same values of R_{min} . The peak current values for equal R_{min} , are in the respective ratios of 1 to 1.5 to 2.5. The level at which saturation occurs is roughly proportional to $10 \log I_p^2$. Thus, for a 2.5 to 1 variation of I_p , the saturation level changes by about 8 db. Fortunately, this variation is considerably larger than is the noise figure variations for each material so that a net result of about 5 db in dynamic range is effected by using a gallium arsenide diode in place of a gallium antimonide device.

C_t (total capacitance) is $C_j + C_p$ (Package Capacitance)

Shot Noise Contribution (K)

$$K = 20 I_o R_n$$

I_o = bias current at low noise point

R_n = negative resistance measured at I_o

Gallium Arsenide Tunnel Diodes for Microwave Oscillator

MA-4C700 Series
MA-4C710 Series
MA-4C720 Series

Designed specifically for Microwave Oscillator Applications, these GaAs Tunnel Diodes feature low noise and low DC power requirements.

CASE STYLES

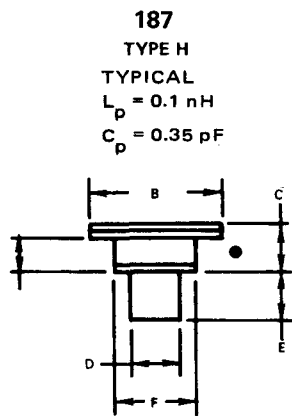

DIM.	INCHES		MM	
	MIN.	MAX.	MIN.	MAX.
A	.013	.017	.330	.431
B	.078	.082	1.98	2.08
C	.023	.032	.584	.813
D	.024	.026	.609	.660
E	.029	.031	.736	.787
F	.048	.052	1.22	1.32

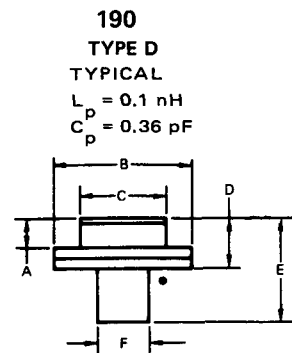

DIM.	INCHES		MM	
	MIN.	MAX.	MIN.	MAX.
A	.015	.019	.381	.482
B	.078	.082	1.98	2.08
C	.045	.055	1.14	1.40
D	.027	.034	.685	.863
E	.048	.059	1.22	1.50
F	.025	.029	.635	.736

NOTE: ● Denotes Cathode End.

Not to scale.

MAXIMUM RATINGS @ $T_A = 25^\circ\text{C}$ (unless otherwise specified)

Incident CW RF Power	0.5 watt
DC Current ¹	5.0 mA
Temperature Range	-65°C to $+100^\circ\text{C}$

ENVIRONMENTAL RATINGS PER MIL-STD-750

	Method	Levels
Temperature, Storage	1031	See max. Rating
Temperature, Operating	—	See max. Rating
		10 cycles
Temperature Cycling	1051	See max. Rating
Shock	2016	1200 g's
Vibration	2056	20 g's
Constant Acceleration	2006	20,000 g's
Humidity	1021	10 days

NOTE:

- I_F of GaAs Tunnel Diodes should be restricted to a value in milliamps equal to or less than $\frac{1}{2}$ the Junction Capacitance value in PF ($I_F \text{ max.} = \frac{C_{jv.}}{2}$)



MICROWAVE ASSOCIATES, INC. BURLINGTON, MASSACHUSETTS

ELECTRICAL CHARACTERISTICS @ $T_A = 25^\circ\text{C}$

I_p (mA) = $5 \pm 10\%$.

M/A ² Type	KMC Type	Min.	Typ.	Typ.	Typ.
		Resistive Cutoff Frequency GHz	Junction Capacitance pF	R_s Ohms	R_m Ohms
MA-4C700	A10005	10	1.1	4.0	45
MA-4C701	A15005	15	.76	4.0	45
MA-4C702	A20005	20	.50	5.0	45
MA-4C703	A25005	25	.36	6.0	45
MA-4C704	A30005	30	.28	7.0	45
MA-4C705	A40005	40	.19	8.0	45

I_p (mA) = $10 \pm 10\%$.

M/A ² Type	KMC Type	Min.	Typ.	Typ.	Typ.
		Resistive Cutoff Frequency GHz	Junction Capacitance pF	R_s Ohms	R_m Ohms
MA-4C710	A10010	10	2.1	2.0	25
MA-4C711	A15010	15	1.1	3.0	25
MA-4C712	A20010	20	.72	4.0	25
MA-4C713	A25010	25	.50	5.0	25
MA-4C714	A30010	30	.37	6.0	25
MA-4C715	A40010	40	.26	7.0	25

I_p (mA) = $20 \pm 10\%$.

M/A ² Type	KMC Type	Min.	Typ.	Typ.	Typ.
		Resistive Cutoff Frequency GHz	Junction Capacitance pF	R_s Ohms	R_m Ohms
MA-4C720	A10020	10	3.5	1.5	10
MA-4C721	A15020	15	1.6	3.0	10
MA-4C722	A20020	20	1.0	4.0	10
MA-4C723	A25020	25	.64	5.0	10
MA-4C724	A30020	30	.53	6.0	10
MA-4C725	A40020	40	.39	7.0	10

NOTE:

2. Add suffix D or H after M/A type number to specify case style.

SPECIAL PRODUCTS

Silicon Epitaxial Wafers and Substrates	233
Ceramic to Metal Packages	237
Low Loss MIS Chip Capacitors	245
High Speed Schottky Diodes for Millimeter Applications	248



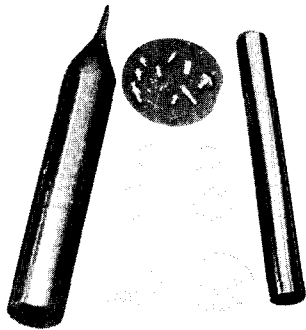

Bulletin 4002

Silicon Epitaxial Wafers and Substrates

FEATURES:

- Low-resistivity substrates
- Epitaxial layer resistivity profiling
- Custom growth techniques/profiles
- Inverse epitaxy
- 1-1/2 to 3-inch diameter
- Epitaxial layers 0.001 to > 100 ohm-cm
- Epitaxial layers < 1 to > 150 microns thick
- Ingot growth, fabrication, polishing
- Silicon nitride/silicon dioxide

MICROWAVE ASSOCIATES SILICON EPITAXIAL WAFERS AND SUBSTRATES –

for discrete devices, MOS and IC applications.

Our primary goals are two-fold, one is to provide epitaxial wafers with designed resistivity profiles through the layer utilizing specific growth techniques. All runs are evaluated by inversion profiling or differential capacitance of actual wafers produced and/or four-point probe resistivity on control wafers. Virtually all types of single and multiple layer structures are available. Our second goal is to provide low-resistivity substrates and ingots for use in discrete devices.

Complete crystal growth, fabrication, slicing, polishing, epitaxy and evaluation capabilities are available.

NOTE: Most wafer specifications result in slip, lineage and dislocation-free material as determined by the ASTM Standard Method of Test for "Crystallographic Perfection of Epitaxial Deposits of Silicon by Etching Techniques."

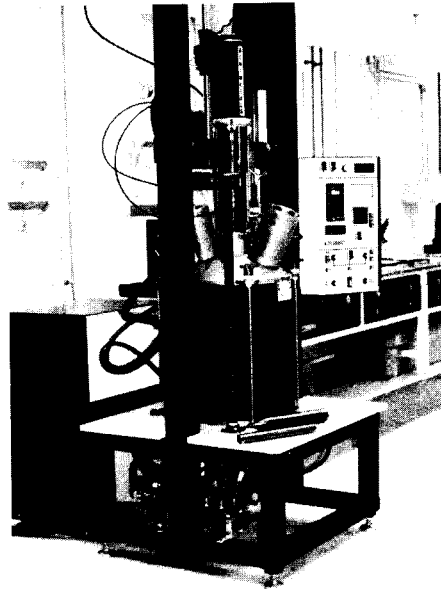

CRYSTAL GROWER

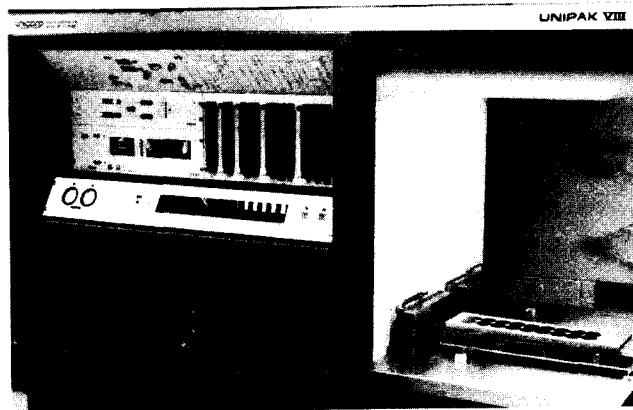

EPITAXIAL REACTOR

WAFER CAPABILITIES

- Up to 3 inch diameter
- Epitaxial layer thickness of less than one micron to greater than 150 microns
- Epitaxial layer resistivity of less than 0.001 to greater than 100 ohm-cm
- Maximum stacking fault density of less than 25/cm² and dislocation density of less than 1000/cm² are standard
- Heavily - doped polished substrates and ingots are available and grown to specifications:
 - Dopants include Arsenic, Antimony and Boron
- Substrate resistivities are available as follows:
 - Boron - Doped (P): as low as 0.0007 ohm-cm
 - Arsenic - Doped (N): as low as 0.0010 ohm-cm
 - Antimony - Doped (N): as low as 0.006 ohm-cm
- Chemically, vapor - deposited Silicon Nitride and/or Silicon Dioxide can be grown on Substrates and Epitaxial wafers
- Wafers can be characterized by inversion profiling or differential capacitance
- Profiling service; as a service, Epitaxial wafers can be characterized by inversion profiling

Wafers are produced as standard according to SEMI specifications where applicable; however, wafers can be produced to any desired parameters.

The following Epitaxial layer tolerance specifications are standard on wafers up to 2-inch diameter:

EPITAXIAL LAYER THICKNESS

Thickness	Within a Wafer	Wafer to Wafer
< 2 microns	±10%	±15%
2-5 microns	± 8%	±12%
5-10 microns	± 8%	±10%
> 10 microns	± 5%	± 8%

EPITAXIAL LAYER RESISTIVITY

Resistivity	Within a Wafer	Wafer to Wafer
< 0.1 ohm-cm	± 8%	±10%
0.1-3 ohm-cm	±10%	±15%
3-10 ohm-cm	±10%	±20%
10-50 ohm-cm	±15%	±30%
50-100 ohm-cm	±20%	±40%
> 100 ohm-cm	±20%	To Be Specified

VISUAL SPECIFICATIONS

Inspection: 100% of the wafers are inspected according to the following criteria:

Epitaxial wafers are viewed in normal room lighting with the unaided eye, following removal from the reactor.

Positive defect criteria:

A maximum number of five positive defects ("spikes") across the wafer area, excluding the outer 5 mm of peripheral area, are permitted. A positive defect is defined as a protrusion greater than 10 microns high and greater than 20 microns in diameter. (Measure under magnification).

The outer 5 mm of peripheral area may contain up to eight positive defects, but the maximum number of defects permitted across the entire wafer is eight.

Negative surface defect criteria:

A maximum of three negative ("pits, voids") defects are permitted across the entire wafer.

No visible haze, interference films or other surface contamination is acceptable.

A maximum number of surface scratches permitted is three, although no scratches are greater than 10 mm in length.

Only unbroken, whole wafers are acceptable.

GENERAL SPECIFICATIONS

Resistivity is measured by inversion profiling, differential capacitance and/or the four-point probe technique - at the center and mid-radius of each of the four quadrants on a representative number of useful wafers.

Thickness is measured by ASTM - corrected or uncorrected infrared reflectance techniques on every wafer where applicable. The specifications apply to the entire wafer excluding the outer 5 mm. Wafer to wafer values are the average of the centerline readings.

Tolerances apply to all types of layers and substrates up to 2 inch diameter, except resistivity of undoped layers on arsenic-doped and low resistivity (≤ 0.005 ohm-cm) boron-doped substrates.

Surface characteristics may differ for layers greater than 10 microns thick grown by thermal decomposition of silane.

Tighter tolerances, specific-shaped impurity profiles, "spike," "step" and "hyper-abrupt" profiles, layer resistivities greater than 100 ohm-cm, very low resistivity substrates, unusual quantities or other special requirements can be grown to specifications mutually agreed to between the customer and Microwave Associates.

WAFER EVALUATION

Wafer runs can be evaluated by inversion profiling - a non-destructive method which plots the impurity profile as a function of thickness through the epitaxial layer.

Each substrate lot is evaluated and characterized for resistivity, orientation, crystalline defects and all physical parameters.

EVALUATION LEVEL

QUALITY A EVALUATION

100% uncorrected IR measurements of epitaxial layer thickness.

Two to five wafers from a run are evaluated by inversion profiling. In some instances, control wafers are also evaluated using the four-point probe method.

QUALITY B EVALUATION

100% uncorrected IR measurements of epitaxial layer thickness.

Resistivity determined by four-point probe measurement of control wafers.

Resistivity tolerance is $\pm 5\%$ higher for wafer-to-wafer values in each category.

QUALITY C EVALUATION

(for epitaxial layers ≤ 2 microns thick)

Representative samples from each run are evaluated for resistivity and thickness of the epitaxial layer where applicable, by ASTM corrected IR thickness and inversion profiling; and/or four-point probe measurement of control wafers.

QUALITY D EVALUATION

(n^+ and p^+ inverse epitaxy)

Thickness of every substrate, where applicable, is measured and identified.

All wafers are measured for epitaxial layer thickness and representative samples are measured for resistivity using the four-point probe technique.

ORDERING INFORMATION

Microwave Associates type MA-4935 (epitaxial wafer) - XXXX (to be assigned by MA).

Nominal Qualitative Information Required:

EPITAXIAL LAYER

Type

Thickness (microns)

Resistivity (ohm-cm)

Dopant (N-Phosphorus, P-Boron)

Quality Evaluation Level (A, B, C, D)

SUBSTRATE

Type

Dopant (Boron, Antimony, Arsenic)

Resistivity (ohm-cm)

Diameter (inches)

Thickness (mils)

Orientation $2^\circ - 3^\circ$ off (111) is standard for (111)

Flat (inches) (110) is standard for (111)

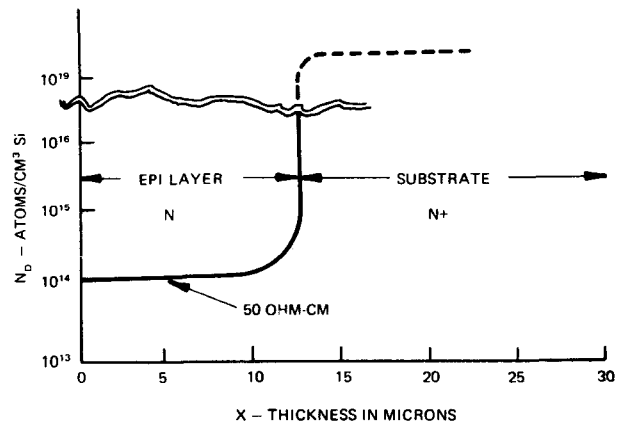

RESISTIVITY PROFILE OF N/N+ EPITAXIAL WAFER

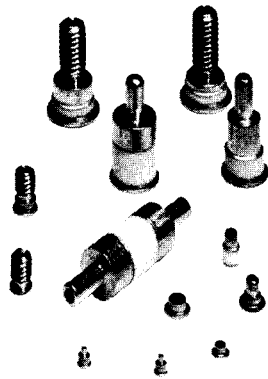

Bulletin 4001

Semiconductor Ceramic to Metal Packages

FEATURES

- Capability for close tolerances
- Custom parts made to order
- Ten year background in high reliability production
- Quality control - all parts checked to 1% A. Q. L and inspection level II in accordance with MIL-STD-105

MICROWAVE ASSOCIATES SEMICONDUCTOR CERAMIC TO METAL PACKAGES

Microwave Associates offers a variety of standard package styles to the circuit design engineer.

All standard ceramic packages are hermetically sealed to meet 1% A. Q. L. unless otherwise specified by the customer and all dimensions and push tests are at 1% A. Q. L. unless otherwise specified.

Microwave Associates high quality control standards comply with MIL-Q-9858. This guarantees uniform performance through advanced manufacturing and packaging techniques. Optimum strength and bonding compatibility is assured in our modern and contamination free manufacturing facilities.

The Company also offers a complete engineering service to assist our customers with special design problems or requirements. Custom engineered ceramic-to-metal packages will be supplied upon request.

Caps are available upon request.

CERAMIC TO METAL SEALS

Microwave Associates' capability in the development and production of precision ceramic to metal seals is demonstrated by the broad number of packages which are illustrated in this brochure. Examples include microwave windows, Gunn tuners, cathode supports, tuning rings, high voltage bushings, and various assemblies for microwave power tubes.

Of course, all seals are fabricated to meet the most stringent environmental requirements.

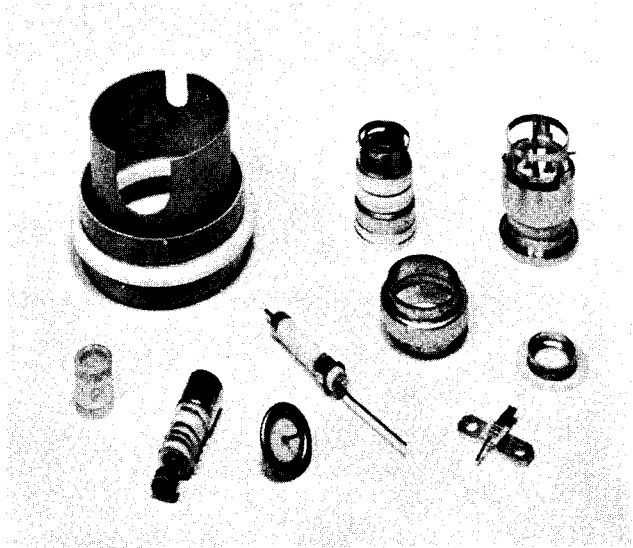

MATERIAL

Ceramic: 94 - 96% AL_2O_3

FLANGE

Kovar
Copper-clad Kovar (Standard)
Copper

BASE

Te-Cu (Standard)
OFHC
Kovar

CAPABILITY

- 10 min. Storage Temperature to 600°C within hermeticity specs.
- Hermiticity: 10^{-8} cc/sec.
- Concentricity: .005 TIR (Standard)

NOTES:

1. Pedestal surface to show no evidence of brazing.
2. Parts may be gold plated to customer specification.
3. Special parts made to customer specs. and tolerances.

PACKAGE STYLES

INCH
MM

Part No.	Base Material
MA 422-41152-1	Kovar
MA 422-41152-2	Copper

Part No.	Dim. "A"	Finish
MA 422-40602	.035-.038 0,89-0,97	16
MA 422-41333	.028-.032 0,71-0,81	8

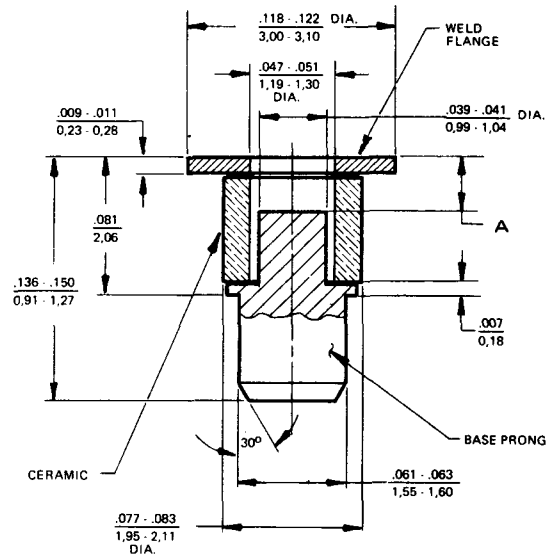
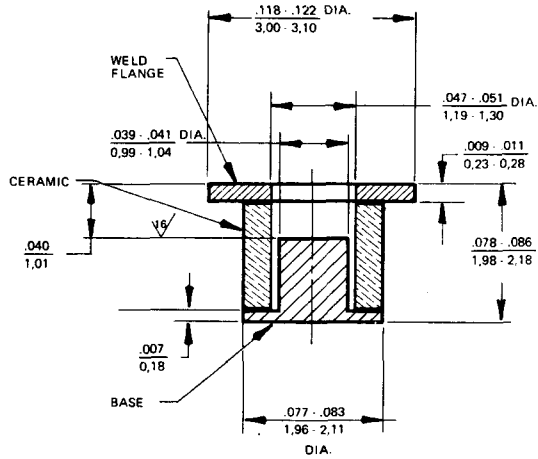

Package Style	Corresponding M/A Case Styles
MA-422-40602	30, 36
MA-422-41333	—
MA-422-41152-1	31, 55, 108
MA-422-41152-2	—
MA-422-40830	32
MA-422-40596	—
MA-422-40881	43, 98
MA-422-41509	142, 143
MA-422-41106	91
MA-422-41019	94, 95
MA-422-41018	96, 97
MA-422-41169	111
MA-422-41067	103
MA-422-41280	117
MA-422-41357	118
MA-422-41423	138
MA-422-41597	153, 154

NOTE:

This information is for reference only. The M/A Case Styles shown above utilize, as one of their parts, the package styles shown.

MA 422-40830

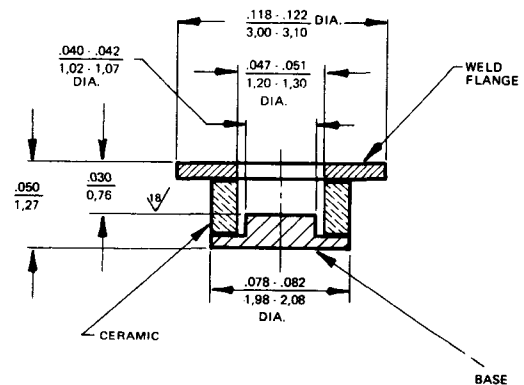

Not to scale.

PACKAGE STYLES (Continued)

INCH
MM

MA 422-40596

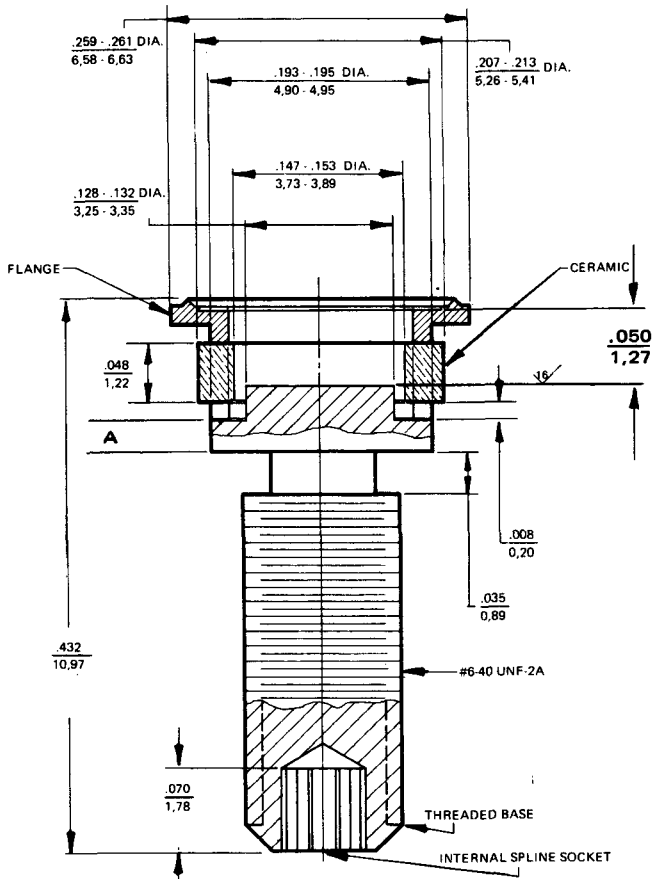
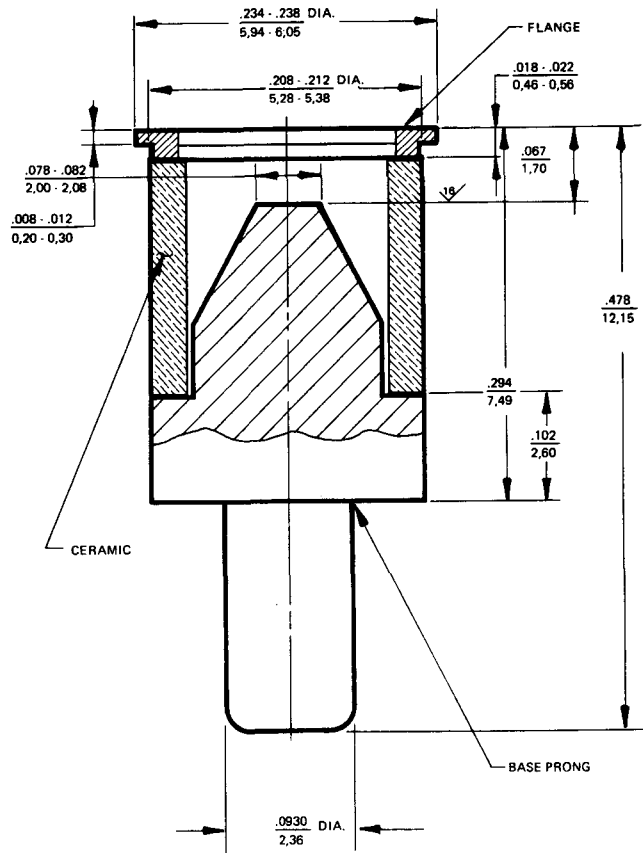

Part No.	Dim. "A"
MA 422-40881	.030 0.76
MA 422-41509	.075 1.91

Not to scale.

PACKAGE STYLES (Continued)

INCH
MM

MA 422-41106

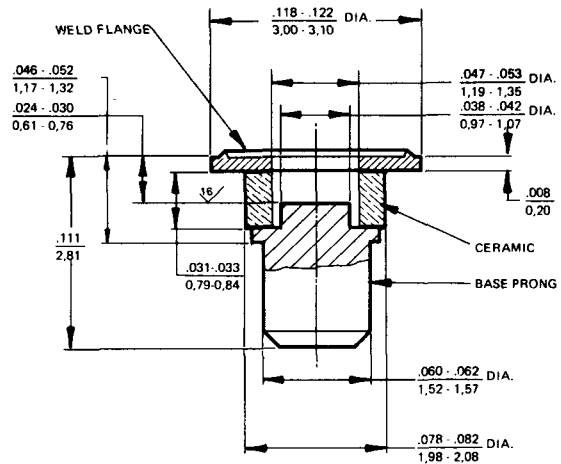

MA 422-41019

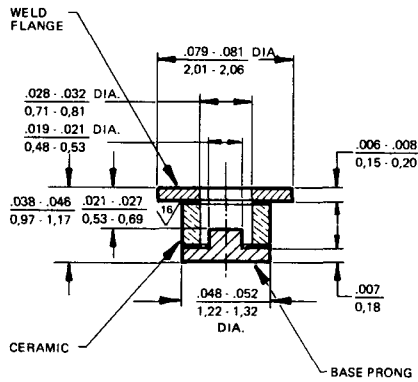

MA 422-41018

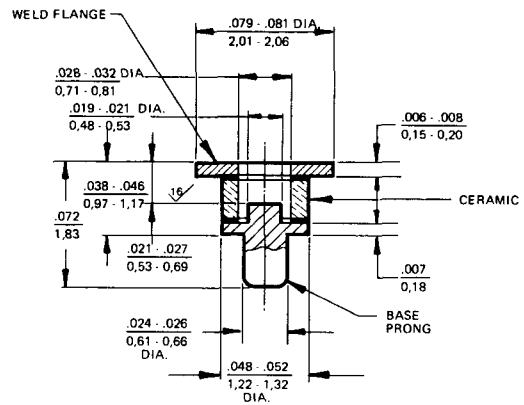

Not to scale.

PACKAGE STYLES (Continued)

INCH
MM

MA 422-41067

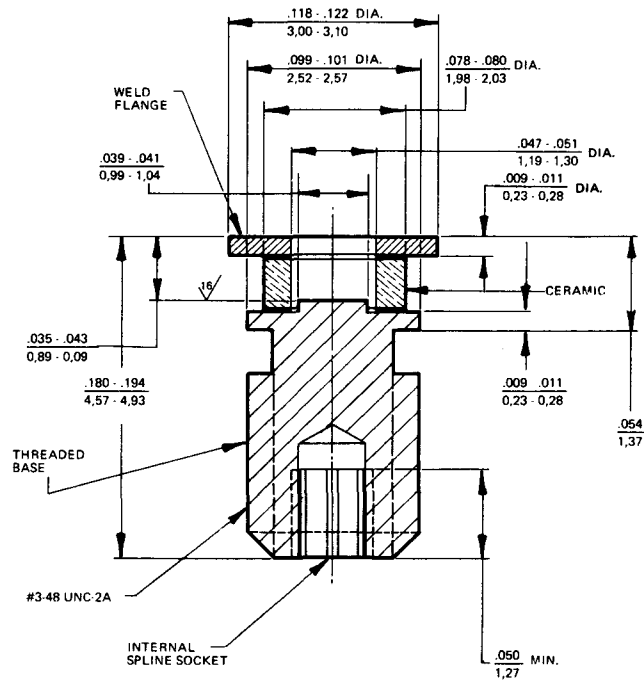

MA 422-41169

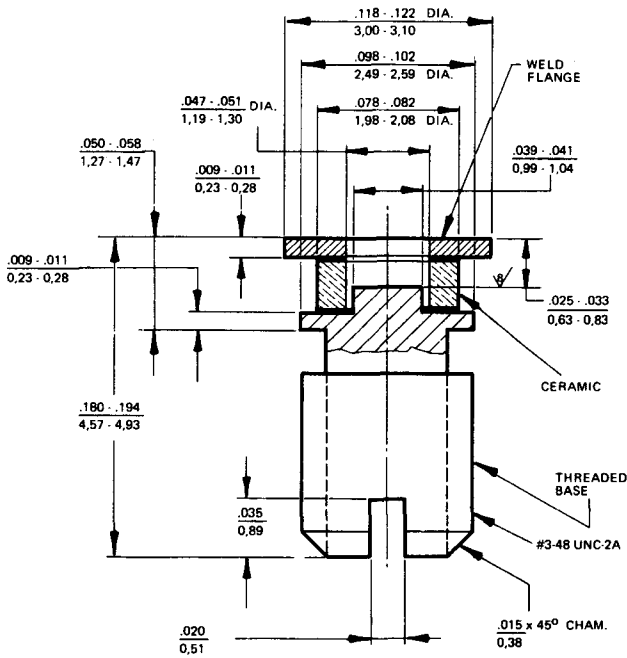

MA 422-41280

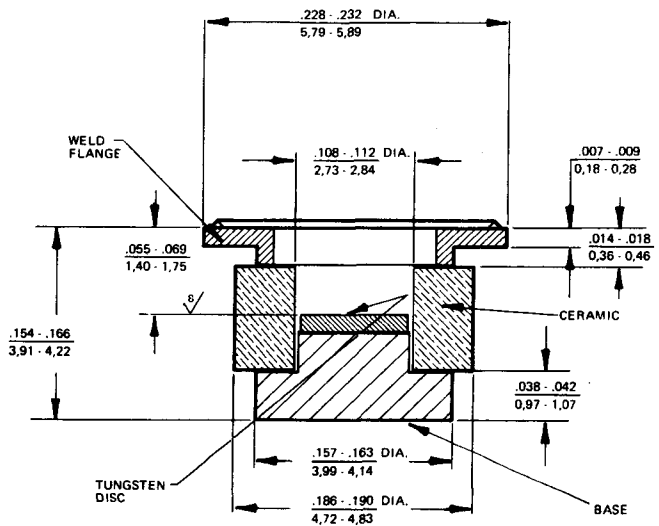

Not to scale.

PACKAGE STYLES (Continued)

INCH
MM

MA 422-41357

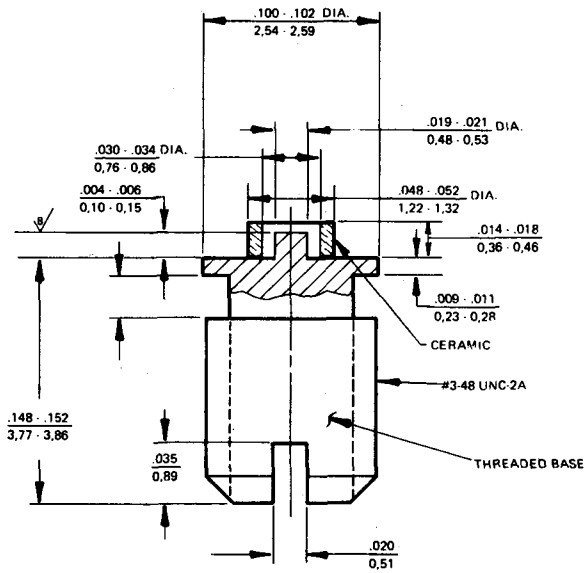

MA 422-41423

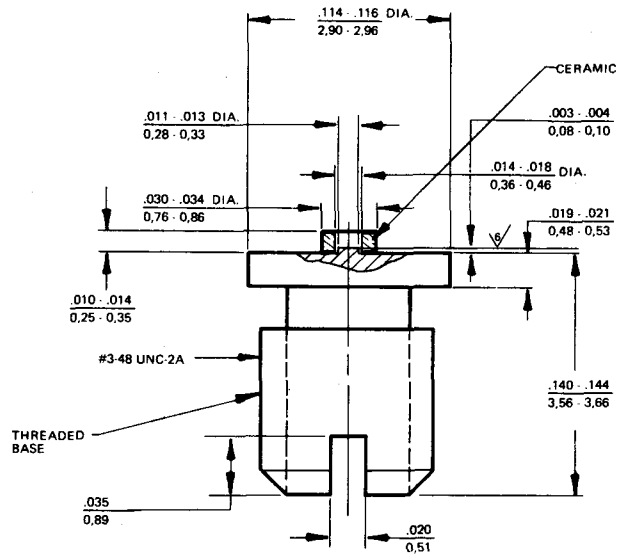

MA 422-41597

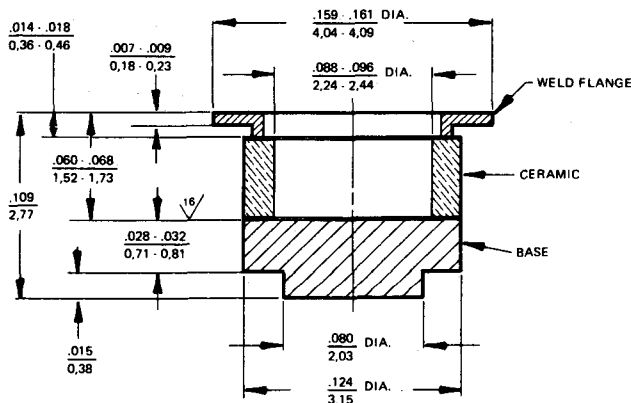

Not to scale.

All specifications are subject to change without notice.

Silicon MIS Capacitors

Bulletin 4052A

MA-4M Series

SPECIAL PRODUCTS

DESCRIPTION

The MA-4M series of silicon chip capacitors utilizes a non-oxide insulator as the dielectric layer. They offer improved reliability and ruggedness over similar MOS capacitors. They exhibit higher capacitance per unit area, resulting in smaller chip size. Refractory metallization techniques are used for contacts thus providing excellent metal to semiconductor adhesion. All chip capacitors in this series are saw-cut from their wafer.

APPLICATIONS

Silicon MIS capacitors are high Q devices, giving excellent insertion loss characteristics for high frequency applications compared with ceramic chip capacitors. They are used from UHF through Ku-band and exhibit less than 0.1 dB insertion loss over this frequency range.

MAXIMUM RATINGS

Operating Temperature	-55°C to +200°C
Voltage Breakdown	125 Volts Min.
Temperature Coefficient	180 PPM/°C

TYPICAL APPLICATIONS IN RF CIRCUITS

- D-C blocks, Capacitive Coupling
- R-F Bypass Capacitors and Fixed Capacitive Loads
- Tuning of Oscillators, Multipliers or Filter sections

OUTLINE DIMENSIONS

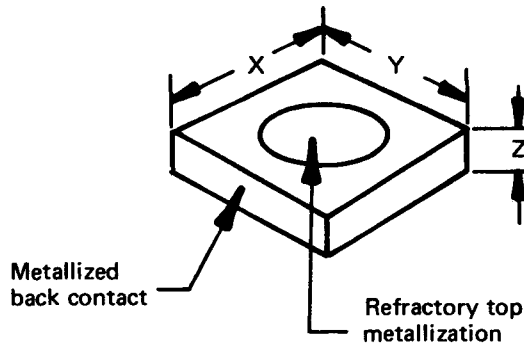

KEY	
INCH	
MM	

Nominal Dimensions	Case Style 134	Case Style 132	Case Style 199	Case Style 200	Case Style 201	Case Style 202
X	$\frac{0.014}{0,36}$	$\frac{0.022}{0,56}$	$\frac{0.030}{0,76}$	$\frac{0.040}{1,02}$	$\frac{0.050}{1,27}$	$\frac{0.065}{1,65}$
Y	$\frac{0.014}{0,35}$	$\frac{0.022}{0,56}$	$\frac{0.030}{0,76}$	$\frac{0.040}{1,02}$	$\frac{0.050}{1,27}$	$\frac{0.065}{1,65}$
Z	$\frac{0.0045}{0,11}$	$\frac{0.0045}{0,11}$	$\frac{0.0045}{0,11}$	$\frac{0.0045}{0,11}$	$\frac{0.0045}{0,11}$	$\frac{0.0045}{0,11}$

ELECTRICAL CHARACTERISTICS @ $T_A = 25^\circ\text{C}$

Capacitance ² pF	Model ⁴ Number	Case ⁶ Style
1	MA-4M0001	134
5	MA-4M0005	132
10	MA-4M0010	132
20	MA-4M0020	199
25	MA-4M0025	199
30	MA-4M0030	199
40	MA-4M0040	199
50	MA-4M0050	199
60	MA-4M0060	199
70	MA-4M0070	199
80	MA-4M0080	199
90	MA-4M0090	200
100	MA-4M0100	200
125	MA-4M0125	200
150	MA-4M0150	200
175	MA-4M0175	201
200	MA-4M0200	201
250	MA-4M0250	201
300	MA-4M0300	202

NOTES:

- Special devices with breakdown voltage ratings at 400 Volts D-C are available.
- $\pm 10\%$ Tolerance. Data is measured at 1 MHz, 25°C using a Boonton Model 75D Bridge.
- These chips are capable of withstanding 100 Volts at 150°C for 250 hours with no capacitance change.
- Contacting leads can be provided on special request.
- Each MIS capacitor has gold contacts, both front and back.
- Additional chip sizes are available on request for specific capacitances within the limitations of contact size needed for fabrication.

Gallium Arsenide Schottky Diodes

Millimeter Applications

DESCRIPTION

Microwave Associates has just introduced a line of low noise zero bias Gallium Arsenide Schottky diodes for millimeter wave receiver applications up to and beyond 100 GHz. The diodes are optimized for mixing and detecting of very weak signals, and are available in hermetically sealed packages as well as chips.

The advantage of Gallium Arsenide material over silicon is that its electron mobility is six to seven times greater than that of silicon. This higher electron mobility gives rise to lower spreading resistance, higher cut-off frequency and lower thermal noise.

Chips used for applications at 90 GHz and above carry a multitude of Schottky diodes to be contacted with a whisker. Diodes optimized for 90 GHz exhibit a typical junction capacitance of .005 pF and spreading resistance of 10Ω , resulting in values of cut-off frequency in excess of 1000 GHz. At lower frequencies, both chips and packaged devices are used, the latter consisting of a thermo-compression bonded GaAs Schottky chip mounted in small hermetically sealed ceramic packages.

ELECTRICAL CHARACTERISTICS @ $T_A = 25^\circ\text{C}$

Model Number	Frequency GHz	Typ. Junction Capacitance pF	Series Resistance Ohms	Max. ¹ Noise Figure dB	TSS ² -dBm	Case ³ Style
MA-40401	36	.05	4-8	7.5	50	135
MA-40402	36	.05	4-8	7.5	50	100
MA-40403	36	.05	4-8	7.5	50	120
MA-40406	36	.05	4-8	7.5	50	119
MA-40408	60	.04	5-10	8.5	48	206
MA-40409	60	.04	5-10	8.5	48	195
MA-40410	90	.005	6-12	10.0	45	195
MA-40412	90	.005	6-12	10.5	45	206

NOTES:

- $F_{IF} = 30$ MHz; $NF_{IF} = 1.5$ dB; $P_{LO} = 2$ mW; 0 Volts Bias.
- Video Bandwidth = 2 MHz
- Complete case style description as well as other case styles are available on request.



MICROWAVE ASSOCIATES, INC. BURLINGTON, MASSACHUSETTS

INDEX OF MODEL NUMBERS

Model Number	Page	Model Number	Page	Model Number	Page
1N21D	8	1N833A	43	2N3571	200
1N21E	8	1N833B	43	2N3572	200
1N21F	8	1N1611	47	2N3683	200
1N21G	8	1N1611A	47	2N3839	200
1N21WE	9	1N1611B	47	2N3880	200
1N21WG	9	1N1838	16	2N3953	200
1N23C	8	1N2102	47	2N5031	200
1N23D	8	1N2771	17	2N5032	200
1N23E	8	1N3118	148	2N5053	200
1N23F	8	1N3128	148	2N5054	200
1N23G	8	1N3129	148	2N5179	200
1N23H	8	1N3130	148	A0000.5	148
1N23WE	9	1N3138	148	A00001	148
1N23WG	9	1N3143	17	A00005	148
1N26B	11	1N3655	16	A00010	148
1N32	47	1N3655A	9	A00020	148
1N53	10	1N3655B	16	A00050	148
1N53A	10	1N3712	148	A00100	148
1N53B	10, 11	1N3713	148	A00200	148
1N53C	10	1N3714	148	A0500.5	148
1N53D	10	1N3715	148	A05001	148
1N78B	10	1N3716	148	A05005	148
1N78C	10, 11	1N3717	148	A05010	148
1N78D	10	1N3719	148	A05020	148
1N78E	10	1N3720	148	A05050	148
1N78F	10	1N3721	148	A10005	229
1N78G	10	1N3745	9, 16	A10010	229
1N82A	14	1N3778	17	A10020	229
1N149	16	1N3847	148	A15005	229
1N263	16	1N3848	148	A15010	229
1N415C	8	1N3849	148	A15020	229
1N415D	8	1N3850	148	A20005	229
1N415E	8	1N3851	148	A20010	229
1N415F	8	1N3852	148	A20020	229
1N415G	8	1N3853	148	A25005	229
1N415H	8	1N3854	148	A25010	229
1N416D	8	1N3856	148	A25020	229
1N416E	8	1N3857	148	A30005	229
1N416F	8	1N3858	148	A30010	229
1N416G	8	1N3859	148	A30020	229
1N830	47	1N3860	148	A40005	229
1N830A	47	1N4379	47	A40010	229
1N831	13	1N4600	16	A40020	229
1N831A	13	1N4601	16	ABD100	76
1N831B	13	1N4602	16	ABD250	76
1N831C	13	1N4603	16	ABDX25	76
1N832	13	1N4604	16	ABDX50	76
1N832A	13	1N4605	16	G0000.5	148
1N832B	13	1N5767	125	G00001	148
1N832C	13	2N2857	200	G00005	148
1N833	43	2N3570	200	G00010	148

INDEX OF MODEL NUMBERS

Model Number	Page	Model Number	Page	Model Number	Page
G00020.....	148	JAN 1N23WEMR.....	9	KD5523.....	204
G00050.....	148	JAN 1N23WG.....	9	KD5525.....	204
G00100.....	148	JAN 1N23WGM.....	9	KD5526.....	204
G00200.....	148	JAN 1N23WGMR.....	9	KD5527.....	204
G0500.5.....	148	JAN 1N26B.....	11	KJ6007.....	208
G05001.....	148	JAN 1N26BR.....	11	KJ6008.....	208
G05005.....	148	JAN 1N26BM.....	11	MA-4B300.....	174
G05010.....	148	JAN 1N26BMR.....	11	MA-4C100.....	148
G05020.....	148	JAN 1N32.....	47	MA-4C102.....	148
G05050.....	148	JAN 1N53.....	11	MA-4C103.....	148
G10001.....	225	JAN 1N53B.....	11	MA-4C104.....	148
G10002.....	226	JAN 1N78C.....	11	MA-4C105.....	148
G10015.....	226	JAN 1N78CR.....	11	MA-4C106.....	148
G15001.....	225	JAN 1N78CM.....	11	MA-4C107.....	148
G15002.....	226	JAN 1N78CMR.....	11	MA-4C108.....	148
G15015.....	226	JAN 1N82AG.....	14	MA-4C109.....	148
G20001.....	225	JAN 1N830A.....	47	MA-4C110.....	148
G20002.....	226	JAN 1N831A.....	13	MA-4C111.....	148
G20015.....	226	JAN 1N832B.....	13	MA-4C112.....	148
G25001.....	225	JAN 1N263.....	16	MA-4C113.....	148
G25002.....	226	JAN 1N1838.....	16	MA-4C114.....	148
G25015.....	226	JAN 1N3655A.....	9	MA-4C250.....	225
G25X01.....	225	JAN 1N3655AM.....	9	MA-4C251.....	225
G25X02.....	226	JAN 1N3655AMR.....	9	MA-4C252.....	225
G25X15.....	226	JAN TX 1N5719.....	112	MA-4C253.....	225
G30001.....	225	K2069.....	200	MA-4C254.....	225
G30002.....	226	K2070.....	200	MA-4C255.....	225
G30015.....	226	K2071.....	200	MA-4C256.....	225
G40001.....	225	K2072.....	200	MA-4C257.....	225
G40002.....	226	K2073.....	200	MA-4C258.....	225
G40015.....	226	K2112.....	200	MA-4C260.....	226
G50001.....	225	K2113.....	200	MA-4C261.....	226
G50002.....	226	K2114.....	200	MA-4C262.....	226
G50015.....	226	K2115.....	200	MA-4C263.....	226
G50X01.....	225	K2116.....	200	MA-4C264.....	226
G50X02.....	226	K2117.....	200	MA-4C265.....	226
G50X15.....	226	K2118.....	200	MA-4C266.....	226
GBD100.....	76	K5510.....	204	MA-4C267.....	226
GBD250.....	76	K5511.....	204	MA-4C268.....	226
GBD400.....	76	K5512.....	204	MA-4C270.....	226
GBD500.....	76	K6001.....	208	MA-4C271.....	226
GBDX25.....	76	K6002.....	208	MA-4C272.....	226
GBDX50.....	76	K6003.....	208	MA-4C273.....	226
JAN 1N21WE.....	9	K6009.....	208	MA-4C274.....	226
JAN 1N21WEM.....	9	K6011.....	208	MA-4C275.....	226
JAN 1N21WEMR.....	9	K6012.....	208	MA-4C276.....	226
JAN 1N21WG.....	9	K6021.....	208	MA-4C277.....	226
JAN 1N21WGM.....	9	K6022.....	208	MA-4C278.....	226
JAN 1N21WGMR.....	9	KD5520.....	204	MA-4C400.....	76
JAN 1N23WE.....	9	KD5521.....	204	MA-4C401.....	76
JAN 1N23WEM.....	9	KD5522.....	204	MA-4C402.....	76

INDEX OF MODEL NUMBERS

Model Number	Page	Model Number	Page	Model Number	Page
MA-4C403	76	MA-4M0100	247	MA-4851	24
MA-4C404	76	MA-4M0125	247	MA-4852	24
MA-4C405	76	MA-4M0150	247	MA-4853	24
MA-4C550	148	MA-4M0175	247	MA-4855	25
MA-4C551	148	MA-4M0200	247	MA-4856	24
MA-4C552	148	MA-4M0250	247	MA-4861E	22
MA-4C553	148	MA-4M0300	247	MA-4861F	22
MA-4C554	148	MA-408	47	MA-4861G	22
MA-4C555	148	MA-408A	47	MA-4861H	22
MA-4C556	148	MA-408B	47	MA-4882	24
MA-4C557	148	MA-417	47	MA-4883	24
MA-4C558	148	MA-418	47	MA-8334	115
MA-4C559	148	MA-418A	47	MA-40001	24
MA-4C560	148	MA-418B	47	MA-40002	24
MA-4C561	148	MA-437	17	MA-40003	24
MA-4C562	148	MA-452	47	MA-40006	24
MA-4C563	148	MA-452A	47	MA-40007	24
MA-4C700	229	MA-452B	47	MA-40008	24
MA-4C701	229	MA-461	47	MA-40009	24
MA-4C702	229	MA-461A	47	MA-40012	25
MA-4C703	229	MA-461B	47	MA-40013	25
MA-4C704	229	MA-490B	10	MA-40014	25
MA-4C705	229	MA-490C	10	MA-40015	25
MA-4C710	229	MA-490D	10	MA-40024	58
MA-4C711	229	MA-490E	10	MA-40025	58
MA-4C712	229	MA-490F	10	MA-40026	58
MA-4C713	229	MA-490G	10	MA-40027	58
MA-4C714	229	MA-492C	10	MA-40028	58
MA-4C715	229	MA-492D	10	MA-40029	58
MA-4C720	229	MA-492E	10	MA-40033	26
MA-4C721	229	MA-492F	10	MA-40034	26
MA-4C722	229	MA-493B	10	MA-40035	26
MA-4C723	229	MA-493C	10	MA-40040	58
MA-4C724	229	MA-494	10	MA-40041	58
MA-4C725	229	MA-494A	10	MA-40042	58
MA-4C850	76	MA-494B	10	MA-40043	58
MA-4C851	76	MA-494C	10	MA-40051E	28
MA-4C852	76	MA-494D	10	MA-40051F	28
MA-4C853	76	MA-4116	47	MA-40051G	28
MA-4M0001	247	MA-4123	42	MA-40051H	28
MA-4M0005	247	MA-4123A	42	MA-40052	58
MA-4M0010	247	MA-4123B	42	MA-40053	58
MA-4M0020	247	MA-4128	47	MA-40061	81
MA-4M0025	247	MA-4129	47	MA-40062	81
MA-4M0030	247	MA-4135	17	MA-40071E	28
MA-4M0040	247	MA-4139	47	MA-40071F	28
MA-4M0050	247	MA-4140	47	MA-40071G	28
MA-4M0060	247	MA-4152	47	MA-40071H	28
MA-4M0070	247	MA-4142A	47	MA-40071I	28
MA-4M0080	247	MA-4815	47	MA-40072	58
MA-4M0090	247	MA-4815A	47	MA-40073	58

INDEX OF MODEL NUMBERS

Model Number	Page	Model Number	Page	Model Number	Page
MA-40074	64	MA-40208	55	MA-41206	46
MA-40081	83	MA-40215	55	MA-41207	46
MA-40082	83	MA-40216	55	MA-41220-C	12
MA-40100	34	MA-40220	55	MA-41220-E	12
MA-40101	34	MA-40221	55	MA-41220-F	12
MA-40102	34	MA-40222	55	MA-41220-G	12
MA-40103	34	MA-40230	53	MA-41221-D	12
MA-40104	34	MA-40231	53	MA-41221-E	12
MA-40105	34	MA-40232	53	MA-41221-F	12
MA-40106	34	MA-40233	53	MA-41222	45
MA-40107	34	MA-40234	53	MA-41223	45
MA-40110	34	MA-40235	53	MA-41224	45
MA-40111	34	MA-40236	53	MA-41225	45
MA-40115	34	MA-40237	53	MA-41500	14
MA-40116	34	MA-40240	53	MA-41501	14
MA-40121	34	MA-40241	53	MA-41502	14
MA-40122	34	MA-40242	53	MA-41503	14
MA-40123	34, 38	MA-40243	53	MA-41504	14
MA-40124	34, 38	MA-40244	53	MA-41505	14
MA-40126	34	MA-40248	53	MA-41506	14
MA-40127	34	MA-40249	53	MA-41507	14
MA-40128	34	MA-40251	60	MA-41508	14
MA-40140	34	MA-40252	60	MA-41509	14
MA-40150	34	MA-40253	60	MA-41510	42
MA-40151	34	MA-40254	60	MA-41511	42
MA-40152	34	MA-40255	60	MA-41512	42
MA-40153	34	MA-40256	60	MA-41513	43
MA-40154	34	MA-40257	60	MA-41514	43
MA-40155	34	MA-40258	60	MA-41515	43
MA-40156	34	MA-40265	60	MA-41807	73
MA-40157	34	MA-40266	60	MA-41808	73
MA-40160	34	MA-40267	60	MA-41809	73
MA-40161	34	MA-40268	60	MA-41810	73
MA-40162	34	MA-40270	60	MA-41811	73
MA-40163	34	MA-40271	60	MA-41812	73
MA-40170	34	MA-40273	60	MA-41813	74
MA-40171	34	MA-40401	248	MA-41816	73
MA-40172	34	MA-40402	248	MA-41817	73
MA-40173	34, 38	MA-40403	248	MA-41819	74
MA-40174	34, 38	MA-40406	248	MA-41820	74
MA-40175	38, 63	MA-40408	248	MA-42001	208
MA-40176	34	MA-40409	248	MA-42002	208
MA-40177	34	MA-40410	248	MA-42003	208
MA-40178	34	MA-40412	248	MA-42004	208
MA-40201	55	MA-41201D	11	MA-42005	208
MA-40202	55	MA-41201E	11	MA-42006	208
MA-40203	55	MA-41201F	11	MA-42007	208
MA-40204	55	MA-41201G	11	MA-42008	208
MA-40205	55	MA-41202E	9	MA-42009	208
MA-40206	55	MA-41202F	9	MA-42010	208
MA-40207	55	MA-41205	46	MA-42011	208

INDEX OF MODEL NUMBERS

Model Number	Page	Model Number	Page	Model Number	Page
MA-42012	208	MA-43543	175	MA-45123	136
MA-42020-509	200	MA-43592	175, 176	MA-45124	136
MA-42021-509	200	MA-44010	175	MA-45125	136
MA-42022-509	200	MA-44020	175	MA-45126	136
MA-42023-509	200	MA-44030	175	MA-45127	136
MA-42024-509	200	MA-44040	175	MA-45128	136
MA-42025-509	200	MA-44050	175	MA-45129	136
MA-42026-509	200	MA-44051	175	MA-45141	136
MA-42027-509	200	MA-44052	175	MA-45142	136
MA-42028-509	200	MA-44053	175	MA-45143	136
MA-42029-509	200	MA-44058	175	MA-45144	136
MA-42050	204	MA-44060	175	MA-45145	136
MA-42051	204	MA-44061	175	MA-45146	136
MA-42052	204	MA-44070	175	MA-45147	136
MA-42055	204	MA-44071	175	MA-45148	136
MA-42056	204	MA-44100	174	MA-45149	136
MA-42057	204	MA-44110	174	MA-45156	137
MA-42060	204	MA-44120	174	MA-45157	137
MA-42061	204	MA-44130	174	MA-45158	137
MA-42062	204	MA-44140	174	MA-45159	137
MA-42063	204	MA-44150	174	MA-45160	137
MA-42100	212	MA-44200	175	MA-45161	137
MA-42110	216	MA-44210	175	MA-45165	137
MA-422-40596	240	MA-44220	175, 176	MA-45166	137
MA-422-40602	239	MA-44230	175, 176	MA-45167	137
MA-422-40830	239	MA-44240	175, 176	MA-45168	137
MA-422-40881	240	MA-44250	175, 176	MA-45169	137
MA-422-41018	241	MA-44300	174	MA-45170	137
MA-422-41019	241	MA-44310	174	MA-45171	137
MA-422-41067	242	MA-44320	174	MA-46021	220
MA-422-41106	241	MA-45054	136	MA-46022	220
MA-422-41152-1	239	MA-45055	136	MA-46023	220
MA-422-41152-2	239	MA-45056	136	MA-46024	220
MA-422-41169	242	MA-45062	136	MA-46025	220
MA-422-41280	242	MA-45063	136	MA-46026	220
MA-422-41333	239	MA-45064	136	MA-46027	220
MA-422-41357	243	MA-45065	136	MA-46028	220
MA-422-41423	243	MA-45066	136	MA-46029	220
MA-422-41509	240	MA-45067	136	MA-46030	220
MA-422-41597	243	MA-45068	136	MA-46031	220
MA-43000	174, 176	MA-45101	136	MA-46032	220
MA-43002	174, 176	MA-45102	136	MA-46600-D	140
MA-43004	174, 176	MA-45103	136	MA-46600-E	140
MA-43030	176	MA-45104	136	MA-46600-F	140
MA-43031	176	MA-45105	136	MA-46600-G	140
MA-43032	176	MA-45106	136	MA-46600-H	140
MA-43033	176	MA-45107	136	MA-46600-J	140
MA-43034	176	MA-45108	136	MA-46601-D	140
MA-43035	176	MA-45109	136	MA-46601-E	140
MA-43036	176	MA-45121	136	MA-46601-F	140
MA-43037	176	MA-45122	136	MA-46601-G	140

INDEX OF MODEL NUMBERS

Model Number	Page	Model Number	Page	Model Number	Page
MA-46602-D	140	MA-47089	106	MA-47424	101, 102
MA-46602-E	140	MA-47090	125	MA-47425	103
MA-46602-F	140	MA-47091	106	MA-47426	103
MA-46603-D	140	MA-47100	113	MA-47427	103
MA-46603-E	140	MA-47110	112	MA-47600	113
MA-46604-D	140	MA-47111	113	MA-47890	125
MA-46610-D	140	MA-47120	112	MA-47891	125
MA-46610-E	140	MA-47121	112	MA-47892	125
MA-46610-F	140	MA-47122	112	MA-47893	125
MA-46610-G	140	MA-47123	112	MA-47894	125
MA-46610-H	140	MA-47147	163	MA-47895	125
MA-46611-D	140	MA-47160	86	MA-47896	125
MA-46611-E	140	MA-47161	86	MA-47897	125
MA-46611-F	140	MA-47162	86	MA-47898	125
MA-46611-G	140	MA-47200	120	MA-47899	125
MA-46612-D	140	MA-47201	120	MA-48501-A	193
MA-46612-E	140	MA-47202	120	MA-48501-B	193
MA-46612-F	140	MA-47203	120	MA-48501-C	193
MA-46613-D	140	MA-47204	120	MA-48501-D	193
MA-46613-E	140	MA-47205	120	MA-48501-E	193
MA-46614-D	140	MA-47206	120	MA-48501-F	193
MA-46620-D	140	MA-47207	120	MA-48501-G	193
MA-46620-E	140	MA-47208	120	MA-48501-H	193
MA-46620-F	140	MA-47220	120	MA-48501-I	193
MA-46620-G	140	MA-47221	120	MA-48501-J	193
MA-46621-D	140	MA-47222	120	MA-48501-K	193
MA-46621-E	140	MA-47223	120	MA-48502-A	193
MA-46621-F	140	MA-47301	104	MA-48502-B	193
MA-46622-D	140	MA-47302	104	MA-48502-C	193
MA-46622-E	140	MA-47400	96, 97	MA-48502-D	193
MA-46623-D	140	MA-47401	96, 97	MA-48502-E	193
MA-46623-E	140	MA-47402	96, 97	MA-48502-F	193
MA-46624-D	140	MA-47403	96, 97	MA-48502-G	193
MA-47041	103	MA-47404	96, 97	MA-48502-H	193
MA-47047	113	MA-47405	96, 97	MA-48502-I	193
MA-47051	101, 102	MA-47406	113	MA-48502-J	193
MA-47052	101, 102	MA-47407	113, 125	MA-48502-K	193
MA-47053	103	MA-47408	101, 102	MA-48503-A	193
MA-47054	103	MA-47409	125	MA-48503-B	193
MA-47066	125	MA-47410	106	MA-48503-C	193
MA-47075	91, 92	MA-47411	113, 125	MA-48503-D	193
MA-47077	91, 92	MA-47412	106	MA-48503-E	193
MA-47079	91, 92	MA-47413	113	MA-48503-F	193
MA-47080	91, 92	MA-47414	106	MA-48503-G	193
MA-47081	91, 92	MA-47416	113	MA-48503-H	193
MA-47082	91, 92	MA-47418	113	MA-48503-I	193
MA-47083	113	MA-47419	112	MA-48504-A	193
MA-47084	91, 92	MA-47420	112	MA-48504-B	193
MA-47085	106	MA-47421	112	MA-48504-C	193
MA-47086	125	MA-47422	112	MA-48504-D	193
MA-47088	125	MA-47423	112	MA-48504-E	193

INDEX OF MODEL NUMBERS

Model Number	Page	Model Number	Page	Model Number	Page
MA-48504-F	193	MA-48701-J	185	MA-48707-B	185
MA-48504-G	193	MA-48701-K	185	MA-48707-C	185
MA-48504-H	193	MA-48702-A	185	MA-48707-D	185
MA-48505-A	193	MA-48702-B	185	MA-48707-E	185
MA-48505-B	193	MA-48702-C	185	MA-48707-F	185
MA-48505-C	193	MA-48702-D	185	MA-48708-A	185
MA-48505-D	193	MA-48702-E	185	MA-48708-B	185
MA-48505-E	193	MA-48702-F	185	MA-48708-C	185
MA-48505-F	193	MA-48702-G	185	MA-48708-D	185
MA-48505-G	193	MA-48702-H	185	MA-48708-E	185
MA-48506-A	193	MA-48702-I	185	MA-48709-A	185
MA-48506-B	193	MA-48702-J	185	MA-48709-B	185
MA-48506-C	193	MA-48702-K	185	MA-48709-C	185
MA-48506-D	193	MA-48703-A	185	MA-48709-D	185
MA-48506-E	193	MA-48703-A	185	MA-48709-E	185
MA-48506-F	193	MA-48703-B	185	MA-48710-A	185
MA-48507-A	193	MA-48703-C	185	MA-48710-B	185
MA-48507-B	193	MA-48703-D	185	MA-48710-C	185
MA-48507-C	193	MA-48703-E	185	MA-48710-D	185
MA-48507-D	193	MA-48703-F	185	MA-48710-E	185
MA-48507-E	193	MA-48703-G	185	MA-48711-A	185
MA-48507-F	193	MA-48703-H	185	MA-48711-B	185
MA-48508-A	193	MA-48703-I	185	MA-48711-C	185
MA-48508-B	193	MA-48703-J	185	MA-48711-D	185
MA-48508-C	193	MA-48703-K	185	MA-48711-E	185
MA-48508-D	193	MA-48704-A	185	MA-49104	155
MA-48508-E	193	MA-48704-B	185	MA-49106	153, 155
MA-48509-A	193	MA-48704-C	185	MA-49107	153, 155
MA-48509-B	193	MA-48704-D	185	MA-49109	155
MA-48509-C	193	MA-48704-E	185	MA-49110	163
MA-48509-D	193	MA-48704-F	185	MA-49117-118	157
MA-48509-E	193	MA-48704-G	185	MA-49121	155
MA-48510-A	193	MA-48704-H	185	MA-49122	153, 155
MA-48510-B	193	MA-48704-I	185	MA-49123	153, 155
MA-48510-C	193	MA-48704-J	185	MA-49124	155
MA-48510-D	193	MA-48705-A	185	MA-49126-118	157
MA-48510-E	193	MA-48705-B	185	MA-49126-138	157
MA-48511-A	193	MA-48705-C	185	MA-49128-138	157
MA-48511-B	193	MA-48705-D	185	MA-49135	155
MA-48511-C	193	MA-48705-E	185	MA-49136	155
MA-48511-D	193	MA-48705-F	185	MA-49137	155
MA-48511-E	193	MA-48705-G	185	MA-49138	155
MA-48701-A	185	MA-48705-H	185	MA-49139	163
MA-48701-B	185	MA-48705-I	185	MA-49140-118	157
MA-48701-C	185	MA-48706-A	185	MA-49145	163
MA-48701-D	185	MA-48706-B	185	MA-49146	163
MA-48701-E	185	MA-48706-C	185	MA-49148	163
MA-48701-F	185	MA-48706-D	185	MA-49151	155
MA-48701-G	185	MA-48706-E	185	MA-49152	155
MA-48701-H	185	MA-48706-F	185	MA-49153	155
MA-48701-I	185	MA-48707-A	185	MA-49154	155

INDEX OF MODEL NUMBERS

Model Number	Page	Model Number	Page	Model Number	Page
MA-49156	155	MA-7700A-0005	67	MA-7717N-0004	70
MA-49157	153, 155	MA-7700K-0001	67	MA-7717N-0005	70
MA-49158	153, 155	MA-7700K-0002	67	MA-7717N-0006	70
MA-49159	155	MA-7700K-0003	67	MA-7717N-0007	70
MA-49161	155	MA-7707J-0003	68	MA-7717N-0008	70
MA-49162	153, 155	MA-7707J-0012	68	MA-7742J-0001	69
MA-49163	153, 155	MA-7707J-0013	68	MA-7742N-0005	69
MA-49164	155	MA-7707N-0006	68	MA-7742N-0007	69
MA-49172	170	MA-7707N-0008	68	MA-7742N-0009	69
MA-49173	170	MA-7707N-0009	68	MA-7742N-0011	69
MA-49177	170	MA-7709A-0001	68	MA-7742N-0012	69
MA-49178	170	MA-7709A-0003	68	MA-7744A-0001	69
MA-49179	170	MA-7709A-0005	68	MA-7744A-0003	69
MA-49180	170	MA-7709A-0007	68	MA-7744A-0005	69
MA-49181	170	MA-7709A-0009	68	MA-7744A-0007	69
MA-49182	170	MA-7709A-0011	68	MA-7744A-0009	69
MA-49183	163	MA-7715A-0001	70	MA-7744A-0012	69
MA-49184	163	MA-7715A-0002	70	MA-8342-0005	129
MA-49185	163	MA-7715A-0003	70	MA-8342-0006	129
MA-49186	163	MA-7715A-0004	70	MA-8342-0008	129
MA-49187	163	MA-7715A-0005	70	MA-8343-0001	131
MA-49188	163	MA-7715A-0006	70	MA-8343-0005	131
MA-49189	163	MA-7715A-0007	70	MA-8343-0006	131
MA-49260	164	MA-7715A-0008	70	MA-8345-0001	133
MA-49265	164	MA-7715A-0009	70	MA-8345-0002	133
MA-49508	153	MA-7717J-0009	70	MA-8345-0003	133
MA-49618	153	MA-7717N-0001	70		
MA-49628	153	MA-7717N-0002	70		
MA-7700A-0004	67	MA-7717N-0003	70		

U.S.A. SALES REPRESENTATIVES

NORTHEAST

NEW ENGLAND

Burlington Sales, Inc.
97 Cambridge Street
Burlington, MA 01803
Tel. (617) 272-7655

MIDDLE ATLANTIC

UPSTATE NEW YORK

T' Electronics Co., Inc.
4054 New Court Avenue
Syracuse, NY 13206
Tel. (315) 463-8592
TWX 710-541-0554

T' Electronics Co., Inc.
2 E. Main Street
Victor, NY 14564
Tel. (716) 924-9101
TWX 510-254-8542

NEW YORK CITY, LONG ISLAND, NORTHERN NEW JERSEY, WESTERN CONNECTICUT

ERA, Incorporated
One Dupont Street
Plainview, NY 11803
Tel. (516) 822-9890
TWX 510-221-1849

WASHINGTON, D.C. MARYLAND, VIRGINIA, AND NORTH CAROLINA

Burgin-Kreh Associates, Inc.
6100 Baltimore National Pike
Baltimore, MD 21228
Tel. (301) 788-5200
TWX 710-862-1450

Burgin-Kreh Associates, Inc.
P.O. Box 268
Kingston, TN 37763
Tel. (615) 690-6100

Burgin-Kreh Associates, Inc.
P.O. Box 19510
Raleigh, NC 27609
Tel. (919) 781-1100

Burgin-Kreh Associates, Inc.
P.O. Box 4254
Lynchburg, VA 24502
Tel. (804) 239-2626

SOUTHEAST

FLORIDA, GEORGIA, ALABAMA

Mr. Richard Kirchberger
Microwave Associates, Inc.
1010 East Atlantic Blvd.
Pompano Beach, FL 33060
Tel. (305) 943-6900

Mr. Clint Francis
Microwave Associates, Inc.
Suite 115
14 Perimeter Park
Atlanta, GA 30341
Tel. (404) 455-3818

SOUTHWEST

TEXAS, OKLAHOMA, ARKANSAS, LOUISIANA

Microwave Associates, Inc.
811 South Central Expressway
Richardson, TX 75080
Suite 546
Tel. (214) 234-2463
TWX 910-867-4769

ARIZONA, NEW MEXICO, COLORADO, UTAH

Microwave Associates, Inc.
7336 E. Shoeman Lane, Suite 108W
Scottsdale, AZ 85251
Tel. (602) 947-5431
TWX 910-950-1281

WEST COAST

WASHINGTON, OREGON

C.K. Shanks & Associates, Inc.
4110 W. Charming Way
P.O. Box 25385
Portland, OR
Tel. (503) 292-5656

NORTHERN CALIFORNIA, NEVADA

Microwave Associates, Inc.
1362 Borregas Avenue
Sunnyvale, CA 94086
Tel. (408) 734-2320
TWX 910-339-9248

SOUTHERN CALIFORNIA

Microwave Associates, Inc.
5855 Green Valley Circle
Suite 200
Culver City, CA 90320
Tel. (213) 645-6611
TWX 910-328-6132

MIDWEST

NORTHERN ILLINOIS, SOUTHERN WISCONSIN

Dekotech, Incorporated
10001 W. Grand Avenue
P.O. Box 306
Franklin Park, IL 60131
Tel. (312) 455-5100
TWX 910-227-1761

MISSOURI, KANSAS, NEBRASKA & SOUTHERN ILLINOIS

Midtec Associates
6912 Marlon
Shawnee Mission, KS 66218
Tel. (913) 441-6565

Midtec Associates
110 S. Highway 67
Florissant, MO 63033
Tel. (314) 837-5200

IOWA, MINNESOTA

Seltex Sales Corporation
P.O. Box 128
Prior Lake
Minneapolis, MN 55372
Seltex Sales Corporation
1930 St. Andrews Drive, N.E.
P.O. Box 2172
Cedar Rapids, IA 52405
Tel. (319) 393-1114
TWX 910-525-1329

INDIANA

Delesa Sales
Executive Office Park
2118 Inwood Drive, Suite 117
Ft. Wayne, IN 46805
Tel. (219) 483-9537
TWX 810-332-1407

Delesa Sales
10026 E. 21st Street
Indianapolis, IN 46229
Tel. (317) 894-3778

OHIO, MICHIGAN, WEST VIRGINIA, AND WESTERN PENNSYLVANIA

S.A.I. Marketing Corporation
P.O. Box N
Brighton, MI 48116
Tel. (313) 227-1786
TWX 810-242-1518

S.A.I. Marketing Corporation
2420 Burton Drive S.E.
Grand Rapids, MI 49506
Tel. (616) 942-2504

INTERNATIONAL SALES REPRESENTATIVES

U.S.A. CANADA

MA Electronics Canada Limited
3135 Universal Drive
Mississauga, Ontario
Canada
L4X 2E7
Tel. (416) 625-4605
TWX 610-492-4317

AUSTRALIA

Werner Electronics
Industries Pty., Ltd.
28 Gray Street
Kilkenny, S.A. 5009
Australia
CABLE AA20365M

BELGIUM, NETHERLANDS, LUXEMBURG

Microwave Associates Int'l.
176 Rue Victor Hugo
1040 Brussels
Belgium
Tel. 735-01-95
TELEX 23281
CABLE MELABSA BRUSSELS

BRAZIL

Cosela Ltda.
Rua Da Consolacao
867-CJ. 31
01301 Sao Paulo
Brazil
Tel. 257-3535/258-4325
CABLE "SEMICHIP"

DENMARK

Tage Olsen A/S
Taglverksgrde 37
DK-2100
Copenhagen
Denmark
Tel. (01) 294800
TELEX 15788

FINLAND

Carlo Casagrande Oy
Kalevankatu 4
Helsinki 10
Finland
Tel. 640711
TELEX 12-1677
CABLE CARCAS HELSINKI

FRANCE

Microwave Associates, S.A.
57-59 Rue De La Convention
Paris
France
Tel. 579-2338
TELEX 202100F

GREECE

Andreas E. Doveloglou
20 Voukourestiou Street
Athens 134
Greece
Tel. 623-462
CABLE ANDREWDEV-ATHENS

INDIA

Forbes, Forbes, Campbell & Co., Ltd
Forbes Building, Home Street
P.O. Box 79
Bombay
India
Tel. 268081
TELEX 112369
CABLE STEAMER BOMBAY

ISRAEL

Microkim Limited
Science Based Industries
Technion City, Haifa
Israel
Tel. 04-226820
TELEX 922-46582 Ext. 8313

ITALY

Elettronica Micro-Onde
Via Luigj Chiarelli 19
00137 Rome
Italy
Tel. 82-71-757
TELEX 79278

Elettronica Micro-Onde
Via Andrea Doria, 17
20124 Milano
Italy
Tel. 270922
TELEX 25258

JAPAN

Hakuto Co., Ltd.
Foreign Division
2-29 Toranomon 1-Chome,
Minato-Ku, Tokyo
Japan
Tel. (03) 502-2211
TELEX J22912 BRAPAN
CABLE BRAPAN TOKYO

MEXICO

Mexitek S.A.
Eugenia 408, Dept. 1Y5
APDO Postal 12-1012
Mexico, 12, D.F.
Tel. 536-09-10 or 532-97-51

NEW ZEALAND

Amalgamated Wireless
(Australasia) N.Z., Ltd.
P.O. Box 830
Wellington, 2
New Zealand
Tel. 51-279
TELEX NZ31001

NORWAY

British Imports, A/S
P.O. Box 2582 Solli
Oslo 2
Norway
Tel. 41-59-35
TELEX 16743
CABLE BRITCO OSLO

SOUTH AFRICA

Fairmont Electronics (Pty.) Ltd.
P.O. Box 41102
Craighall, 2024
Transvaal
R.S.A.
Tel. 48-6421 48-6481/2
CABLE "FAIRTRONICS" CRAIGHALL
TELEX 8-3227 SA

SPAIN

Hispano Electronica S.A.
Comandante Zorita 8
Madrid 20
Spain

SWEDEN

Swedish Elektronik A/B
Box 566
191 05 Sollentuna
Sweden
Tel. 08-96-7660
TELEX 13461 Swelink
CABLE TELELINK STOCKHOLM

SWITZERLAND

Technology Resources AG
Aabergergasse 20
3000 Bern
Switzerland
Tel. (031) 22-39-73
TELEX 33450

TAIWAN, HONG KONG

Shigma, Inc. (Taiwan Branch)
Room 404, 4th Floor, Q Bldg.
152 Chung Shan N Road, Sec. 1
Taipei
Taiwan
Tel. 5614300, 4309, 0148 & 0149
TELEX 22590 Shigma
S & T Enterprises Ltd.
P.O. Box 348
Tsai Tse Mui Post Office
Hong Kong
TELEX 80273942

UNITED KINGDOM

Microwave Associates, Ltd.
Dunstable LU5 4SX
Bedfordshire
England
Tel. (0582) 601441
TELEX 82295
CABLE MICROWAVE DUNSTABLE

WEST GERMANY & AUSTRIA

Microwave Associates, GmbH
Waltenburger Strasse 33
D-8 Munchen 80
West Germany
Tel. 089-23 60 v 61
TELEX 5-29103 MAGM

EASTERN EUROPE, EAST GERMANY, POLAND, HUNGARY, BULGARIA, ROMANIA, YUGOSLAVIA, CZECHOSLOVAKIA, U.S.S.R.

Microwave Associates International
14 Warwick Road
London W5
England
Tel. 579-2555

MICROWAVE ASSOCIATES,  INC.